



振华缝纫零件总汇  
ZHENHUA SEWING MACHINE SPARE PARTS TRADE

金振进出口有限公司  
JINZHEN IMPORT & EXPORT CO.,LTD.

金振智能科技(东阳)有限公司  
JINZEN Intelligent Technology (Dongyang) Co., Ltd.

Add: No.46 DongSheng Road,hulu town,  
Dongyang City, Zhejiang  
浙江省东阳市虎鹿镇东岷路46号  
Tel: 0086-579- 8615 0008 8615 2008  
Fax: 0086-579- 8615 1368  
E-mail: zhenhua@jinzen.cc  
Http: www.jinzen.cc



微信公众号: JINZENCHINA

**JINZEN®**  
**One-stop solution**  
缝配服务一站式采购

加盟专线:

☎ 400-622-0008

定价: 人民币398.00元

JINZEN®

2023

**JINZEN®**

Since 1983

**2023**

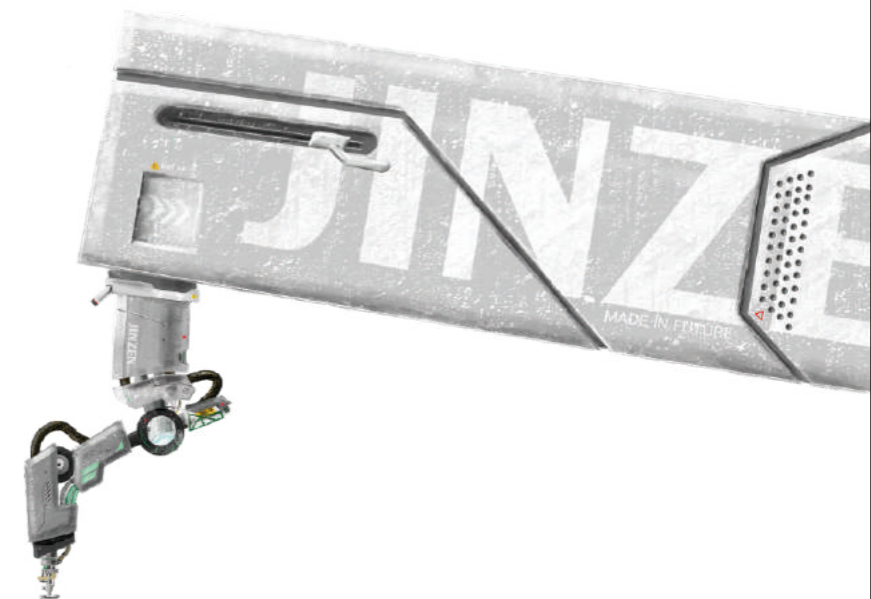

The future manufacturing  
未来制造



雨田品牌策划

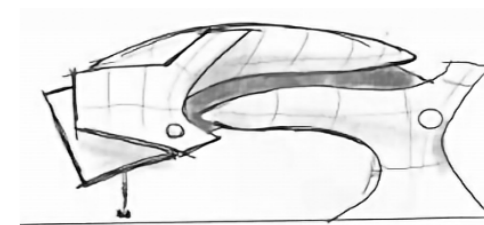

CARING FOR THE EARTH  
LOW-CARBON LIFE  
爱护地球 低碳生活

Jinzen brand,  
always perfusion green theme  
Follow the mission to protect the earth  
Advocate for a better life and contribute to green

金振品牌  
时刻灌注绿色主题  
遵循爱护地球的企业使命  
为倡导绿色美好生活而贡献



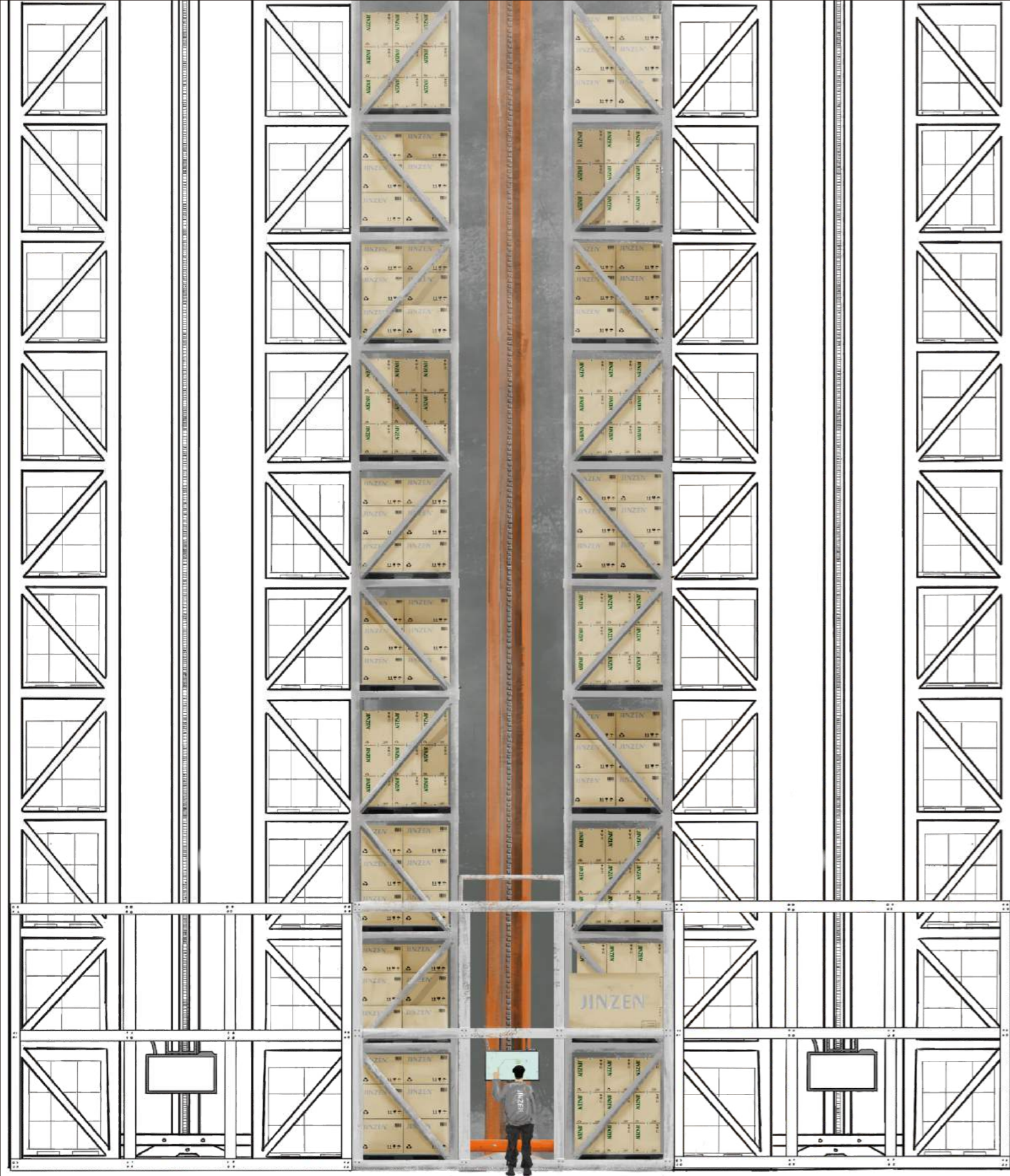

# SEWING MACHINE SPARE PARTS

**JINZEN®**  
One-stop solution  
缝配服务一站式采购

*San Car*



缝配智能服务  
spare parts with intelligent services





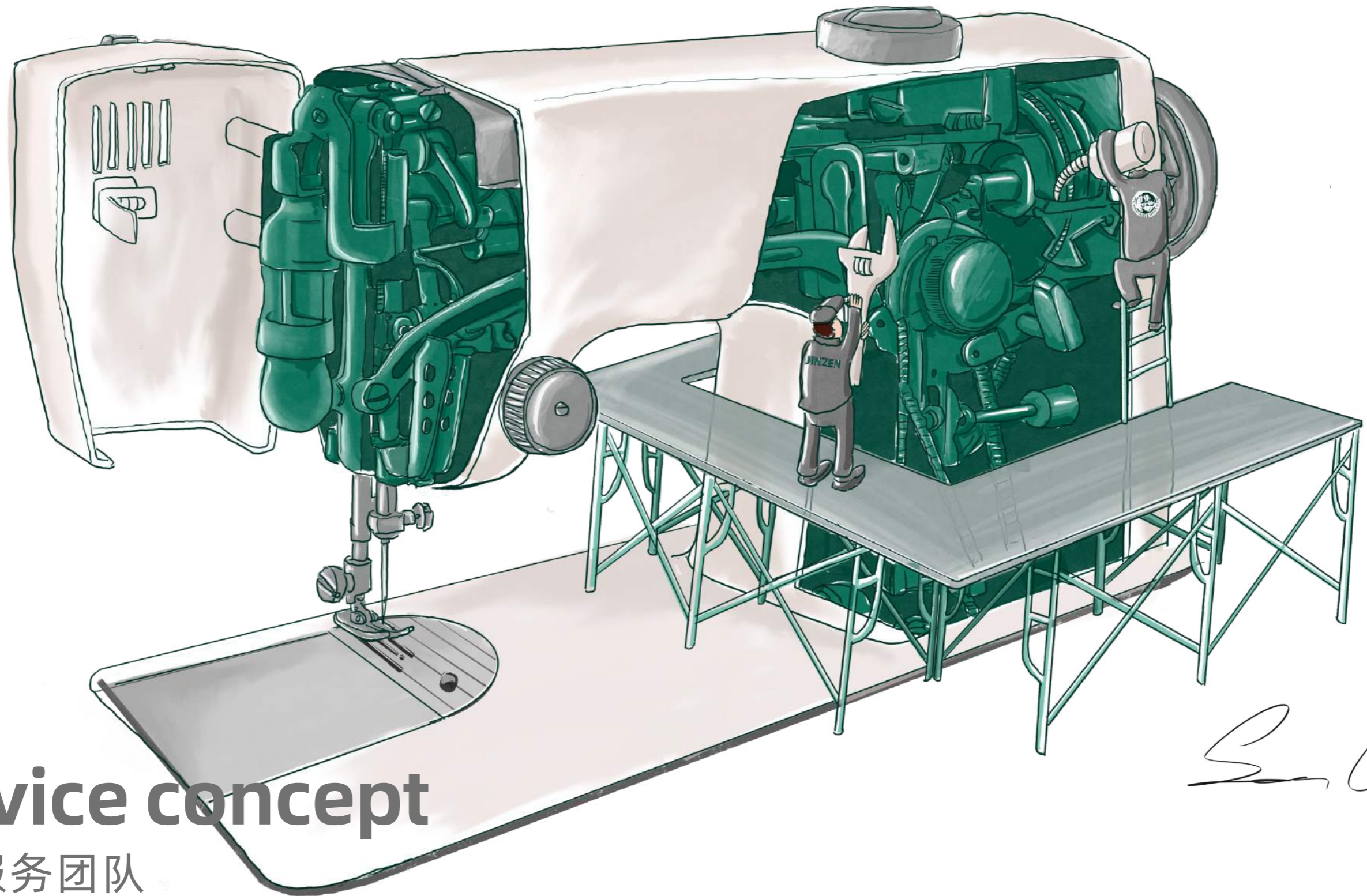

# Service concept

专业服务团队

S. Car

Algeria 阿尔及利亚  
 America 美国  
 Arab 阿拉伯  
 Bengal 孟加拉  
 Brazil 巴西  
 Britain 英国  
 Bulgaria 保加利亚  
 Cambodia 柬埔寨  
 Canada 加拿大  
 Chile 智利  
 Columbia 哥伦比亚  
 Egypt 埃及  
 El Salvador 萨尔瓦多  
 Ethiopia 埃塞俄比亚  
 Fiji 斐济  
 Germany 德国  
 Ghana 加纳  
 Guatemala 危地马拉  
 Hungary 匈牙利  
 India 印度  
 Indonesia 印度尼西亚  
 Iran 伊朗  
 Israel 以色列  
 Italy 意大利  
 Japan 日本  
 Jordan 约旦  
 Kazakhstan 哈萨克斯坦  
 Kenya 肯尼亚  
 Kuwait 科威特  
 Kyrgyzstan 吉尔吉斯斯坦  
 Malaysia 马来西亚  
 Mauritius 毛里求斯  
 Mexico 墨西哥  
 Moldova 摩尔多瓦  
 Morocco 摩洛哥  
 Myanmar 缅甸  
 Nicaragua 尼加拉瓜  
 Nigeria 尼日利亚

Pakistan 巴基斯坦  
 Paraguay 巴拉圭  
 Peru 秘鲁  
 Philippines 菲律宾  
 Poland 波兰  
 Portugal 葡萄牙  
 Qatar 卡塔尔  
 Republic of Uzbekistan 乌兹别克斯坦  
 Romania 罗马尼亚  
 Russia 俄罗斯  
 South Africa 南非  
 South Korea 韩国  
 Spain 西班牙  
 Sri Lanka 斯里兰卡  
 Syrian 叙利亚  
 Taiwan 台湾  
 Tanzania 坦桑尼亚  
 Thailand 泰国  
 Tunisia 突尼斯  
 Turkey 土耳其  
 Ukraine 乌克兰  
 Venezuela 委内瑞拉  
 Vietnam 越南  
 Yemen 也门  
 Zimbabwe 津巴布韦



**JINZEN®**

**Recruiting Global Brand Distributors**

**诚招区域代理商**



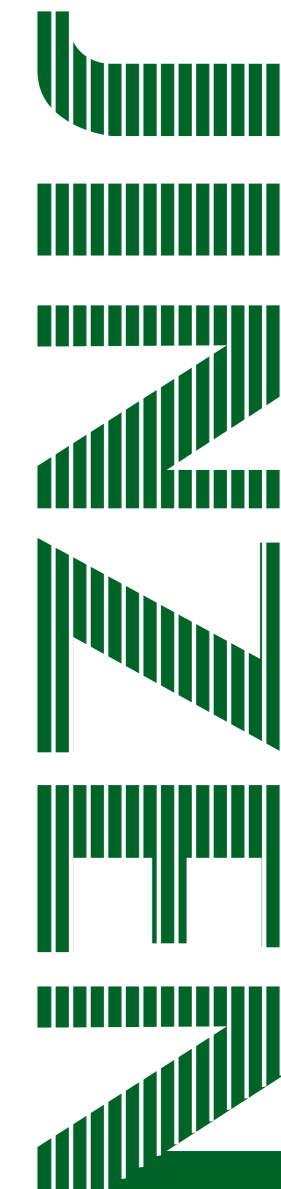

公司创立于1983年，专注于缝纫机配件及辅助设备；现拥有金振品牌产品8大系列5万多种；产品远销50多个国家和地区5000余家客户，战略配套合作伙伴工厂有1000多家；服务全球服装及缝制制造工厂。

2017年应用智能仓储系统，是中国缝制机械协会理事单位、中国缝制机械协会零部件分会轮值会长单位、A级纳税企业。

2019年金振智能科技工厂完成初步建设，逐步打造全智能缝配产业链，以超前意识打造了“未来缝配服务”理念！





Reception Center 会客中心 ▲



Exhibition Center 展示中心 ▲



Marketing Center 营销中心 ▲



SmartStorage 智能仓储 ▲

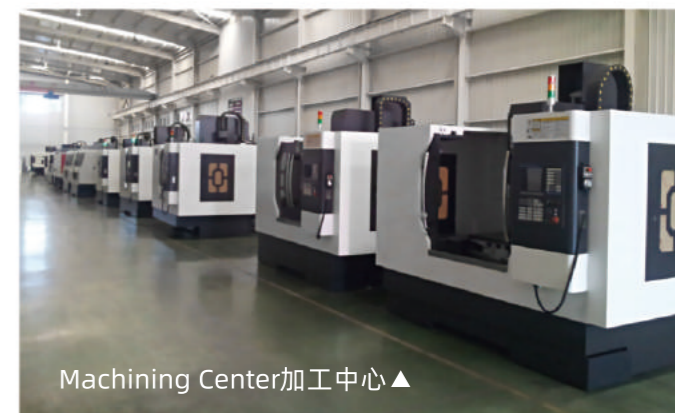

Machining Center 加工中心 ▲



# 品质源于至上的信念

## QUALITY BELIEF

The company was founded in 1983, focusing on sewing machine accessories and auxiliary equipment. Now it has more than 50,000 kinds of 8 series of JINZEN brand products, the products are exported to more than 5,000 customers in more than 50 countries and regions, and there are more than 1,000 strategic supporting partner factories, serving global garment and sewing manufacturers.

In 2017, we installed the first intelligent storage system in the industry. We are the director unit of China sewing machine association, the rotating President unit of China sewing machine association parts branch, and a class A tax paying enterprise. In 2019, JINZEN intelligent technology factory completes the initial construction and gradually builds an intelligent sewing and matching industry chain, creating the concept of "future sewing service" with advanced consciousness.

## 工厂仓库加工产品一体化

Factory warehouse processing products integration





JINZEN®

有一种力量叫

## 品牌

多年来，  
不管市场环境如何变化，  
金振的产品总是随着市场应运而生。  
除了质量、工艺之外，  
不可否认，更离不开金振人的热情服务！

There is a force called  
brand

Over the years, no matter how the market environment changes,  
Jinzen's products always emerge with the market. In addition to the  
quality, the process is undeniable, but also inseparable from the warm  
service of Jinzhen people!



# JINZEN®







“精工细作，终成大器”

EXQUISITE AND SCRUPULOUS WORKING MAKES PERFECT.

JINZEN®



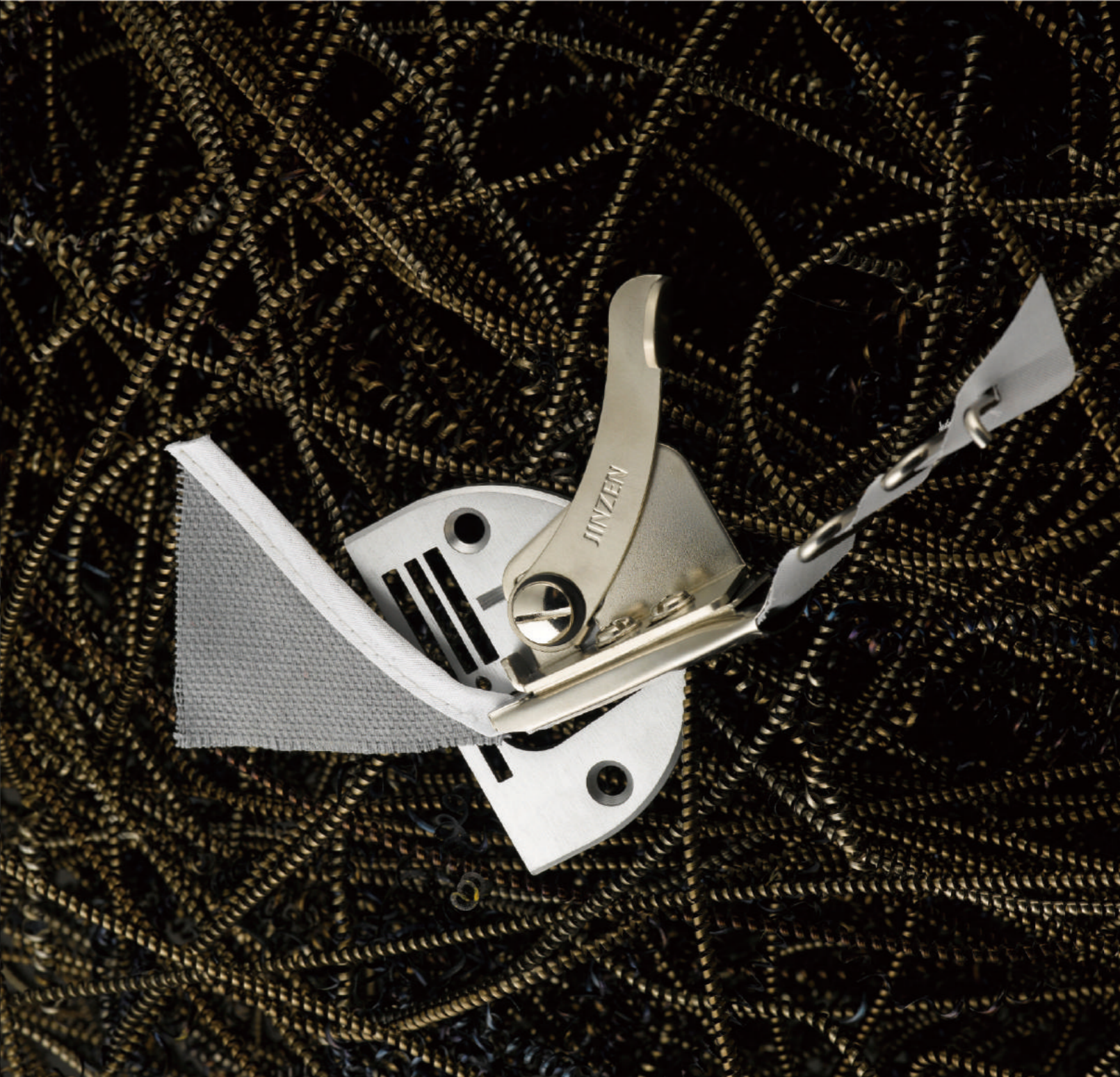

# JINZEN INTELLIGENT TECHNOLOGY (DONGYANG) CO., LTD.

No.46 DongSheng Road,hulu town,Dongyang City, Zhejiang

**JINZEN®**



### JINZEN®

- P014 金振旋梭 JINZEN HOOKS
- P021 金振梭壳 JINZEN BOBBIN CASES
- P026 金振摆梭 JINZEN SHUTTLE HOOKS
- P029 金振梭心 JINZEN BOBBINS
- P032 金振刀具 JINZEN KNIFES
- P048 金振机针 JINZEN NEEDLE
- P050 金振针板 JINZEN NEEDLE PLATES
- P058 金振针位 JINZEN GAUGE SET
- P072 金振送布牙 JINZEN FEED DOG
- P076 金振弯针 JINZEN LOOPERS
- P090 金振针夹 JINZEN NEEDLE CLAMP
- P093 金振压脚 JINZEN PRESSER FOOT
  
- P108 夹线器组件 THREAD TENSION ASM
- P112 打褶器, 定规 ATTACHMENT & GAUGE
- P114 计数器平扣立扣 COUNTER PINGKOULIKOU
- P116 金振卷边筒 JINZEN FOLDER
- P134 套结机拖板, 压脚 FEED PLATE & WORK CLAMP
- P141 各类针杆 NEEDLE BAR

### JUKI

- P152 重机 JUKI 1850
- P154 重机 JUKI 1900/1903
- P156 重机 JUKI 781
- P159 重机 JUKI 373
- P162 重机 JUKI DDL9000
- P164 重机 JUKI 380
- P166 重机 JUKI 1190
- P168 重机 JUKI 2280
- P171 重机 JUKI 271/391
- P172 重机 JUKI MO2516
- P174 重机 JUKI MO3600
- P176 重机 JUKI MO3300
- P178 重机 JUKI 7700/7800
- P182 重机 JUKI 8700
- P184 重机 JUKI 522
- P185 重机 JUKI 3168
- P186 重机 JUKI 515
- P187 重机 JUKI 1790
- P190 重机 JUKI 210D

### brother

- P192 兄弟 BROTHER 101/735
- P194 兄弟 BROTHER 7200
- P196 兄弟 BROTHER 430
- P198 兄弟 BROTHER 430D
- P200 兄弟 BROTHER 814
- P203 兄弟 BROTHER 845
- P204 兄弟 BROTHER 917
- P206 兄弟 BROTHER 927/928
- P210 兄弟 BROTHER 9810/9820
- P212 兄弟 BROTHER 531/551
- P213 兄弟 BROTHER N31/HE800A

### PEGASUS

- P215 飞马 PEGASUS M800
- P216 飞马 PEGASUS M600
- P218 飞马 PEGASUS M700
- P220 飞马 PEGASUS W500
- P222 飞马 PEGASUS W664
- P224 飞马 PEGASUS EX3200/5100
- 飞马 PEGASUS MX3200

### SIRUBA

- P227 银箭 SIRUBA VC008
- P228 银箭 SIRUBA F007/C007
- P230 银箭 SIRUBA 747/757
- P232 银箭 SIRUBA 988

### Kingtex

- P234 宝狮 KINGTEX SH7000

### KANSAI

- P236 关西 KASAI 1404
- P238 关西 KASAI 1508
- P239 关西 KASAI 33 针

### Yamato

- P240 大和 YAMATO AZ8500
- P242 大和 YAMATO 1500
- P244 大和 YAMATO 1500/2500
- P246 大和 YAMATO 2500/2700
- 大和 YAMATO VG3721
- P248 大和 YAMATO 四针六线

### SHING LING

- P250 星菱 SHING LING 777
- P252 星菱 SHING LING SL700

### DÜRKOPP

- P254 杜克普 DURKOPP 558

### SINGER

- P256 胜家 SINGER 20U

### NEWLONG

- P258 牛郎 NEWLONG NP-7

### PFAFF

- P259 百福 PFAFF 335

- P260 高头车 810/820
- P262 罗拉车 591
- P264 罗拉车 9901
- P265 标准 TYPICAL341
- P266 标准 TYPICAL0302/0318
- P268 精工 8B/ 胜家 SINGER591
- P269 削皮机 801
- P270 伊士曼 EASTMAN
- P272 电裁剪 KM
- P274 断布机零件
- P275 圆刀 / 电剪 RS-100/ RS-90
- P276 胶订机 ST9000
- P278 家用机 JA1-1/JA2-2
- P280 多功能 307
- P282 胜家 SINGER974
- P284 兄弟多功能 BROTHER 5500
- P286 真善美 JANOME 2049
- P288 暗缝机 / 大白扣 / 修边机
- P289 杰克
- P290 家用多功能压脚 Sewing Machine Feet & Accessory For Household

### JINZEN®

- P298 金振喷枪, 配件 JINZEN GUN & PARTS
- P300 熨斗, 配件, 熨斗靴 IRON & SHOES
- P314 喷漆 PAINT FOR MACHINE
- P315 标枪, 胶针 TAGGIN GUN & NEEDLE PIN
- P318 剪刀 SCISSORS
- P324 工作灯 MACHINE LIGHT
- P328 工具附件 TOOLS & ATTACHMENT
- P344 皮带罩 BELT COVER
- P346 门板组件 FRONT COVER ASM
- P348 护眼组件 EYE COVER
- P350 挑线杆, 油盘, 线架 THREAD STAND
- P358 电裁剪 CUTTING MACHINE
- P366 拖轮系列 PULLER ATTACHMENT
- P374 成衣剪线机 THREAD TRIMMER
- P386 台湾拖轮 PULLER ATTACHMENT
- P406 金振企业文化 The enterprise culture

#### 温馨提示:

画册的编号解释: JZ代表JINZEN的第一个拼音字母, 数字代表序号, 金振样本中的序号从10001 10002 10003 依次从小到大的顺序排列, 考虑到以后会有增加新的配件或机型, 所以在不同的种类或机型后留有空号码, 由此带来的不便敬请谅解。

#### Warm tips:

Number explanation for this Catalogue: JZ stand for the first phonetic alphabet of JINZEN, Figure stand for the serial number. The serial number of 10001, 10002, 10003 in the JINZEN catalogue turn from small to large order, taking into account that we will have to add new accessories or models, so we remain empty after the number for different types and models, so please understand the inconvenience as the result.





 <p><b>JZ-10001</b> DB1-Z16 KR24 7.24mm</p> <p>For: <b>BROTHER</b> LE2-B861-1. <b>JUKI</b> LZ-27.29.40.271.403 <b>MEIJA</b> G15-2 <b>ADLER</b> 199.289.489 <b>CONSEW</b> 133A.825 <b>SUNSTAR</b> KLZ-371 <b>UNICORN</b> LZ2-H272 (needle slot:16mm)</p>	 <p><b>JZ-10002</b> HSH-7.94A(MTQ) KHS12-RY 7.94mm</p> <p>For: <b>TAJIMA</b> TME.TMEF.TMLE ETC <b>BUTTERFLY</b> GY4-1 <b>TYPICAL</b> GYD20-6 <b>YINGLUN</b> GY101-1 <b>SUNSTAR</b> SWF/A-WE1218-T1201 (small hook)</p>	 <p><b>JZ-10017</b> HSM-A1 KHS20-RTB 7.94mm</p> <p>For: <b>TYPICAL</b> GC6-9.GC6-10 (extra heavy materials.thick lines)</p>	 <p><b>JZ-10018</b> HSH-21-40(J) KRT21-J 8.01mm</p> <p>For: <b>JUKI</b> LH-512.-512-3.515</p>
 <p><b>JZ-10003</b> DB1-Z16B KR24-B 7.24mm</p> <p>For: <b>BROTHER</b> TZ1-B651.B652 BAS-400.LE2-B861-7 <b>I-SIAN</b> IS-335 <b>KING'S</b> HC-335 <b>MILLION SPECIAL</b> MS-335 <b>TAKING</b> TK-652 <b>YULUN</b> YLM-335 (needle slot:16mm)</p>	 <p><b>JZ-10004</b> HSH-7.94A(M1QTS) KHS12-RYNW 7.94mm</p> <p>For: <b>BARUDAN</b> BEMR.BEMS.BEMX (small hook.teflon base)</p>	 <p><b>JZ-10019</b> HSM-A1 KHS20-RTB 7.94mm</p> <p>For: <b>BROTHER</b> DB2-B745-7.B797.B797-5 <b>TAJIMA</b> TMB-E.TMB-W.TMW <b>JUKI</b> DDL-201S (heavy materials) <b>TYPICAL</b> GC6-7</p>	 <p><b>JZ-10020</b> HSH-21-40(AJ) KRT21-R 8.01mm</p> <p>For: <b>JUKI</b> LH-512H.515H (heavy materials) (short gib)</p>
 <p><b>JZ-10005</b> DB1-Z(20) KR24-U 7.24mm</p> <p>For: <b>SINGER</b> 20U.20U13.23 <b>KERDER</b> KD-20U <b>PANDA(JIANN LIAN)</b> JU-20U <b>SIROKUMA</b> LM-600 (needle slot:18mm)</p>	 <p><b>JZ-10006</b> HSH-7.94ATR(MTQ) KHS12-RYP 7.94mm</p> <p>For: <b>TAJIMA</b> TMBE.TME.TME-D TMFD-C.TMFX-C TMLE.TMLG. (Small hook) (under trimming machine)</p>	 <p><b>JZ-10021</b> HSM-ATR(1Q) KHS12-RYPN 7.94mm</p> <p>For: <b>TYPICAL</b> GC2603 GC2605</p>	 <p><b>JZ-10022</b> HSH-31 KRT31-R 7.93mm</p> <p>For: <b>SINGER</b> 21W180.46W61.47W62.63 52W30.31.131W <b>CONSEW</b> 228.228-11.228R-1.11 229.229R.229R-1.238.238-1 282.282R-1.289R-1.358R-1</p>
 <p><b>JZ-10007</b> HSH-7.94A KHS12-R 7.94mm</p> <p>For: <b>BROTHER</b> DB2-B706-5.B714-5.B755-5 <b>JANOME</b> DB-J705.706 <b>MITSUBISHI</b> DB-130-12.13.130G-12. 130G-127.DY-340-12 <b>SINGER</b> 391U.400W.402W.451K. <b>NITAKA</b> TC-1553.1555 <b>NAKAJIMA</b> DSN178-3</p>	 <p><b>JZ-10008</b> HSH-7.94ATR(MTQTS) KHS12-RYPN 7.94mm</p> <p>For: <b>TAJIMA</b> TMBE.TME.TME-D TMFD-C.TMFX-C TMLE.TMLG. (Small hook.teflon base) (under trimming machine)</p>	 <p><b>JZ-10023</b> HSM-ATR(1Q) KHS12-RYPN 7.94mm</p> <p>For: <b>BROTHER</b> BAS-412.416.423</p>	 <p><b>JZ-10024</b> HSH-31(B) KRT31-11S 7.93mm</p> <p>For: <b>SEIKO</b> CW-1.7.7B.8.8B.8V.8BV <b>SINGER</b> 47W70.131W <b>CONSEW</b> 207.223.223R.223R-1.227.382. 382R.388.388R-1.389.389R-1 (full gib)</p>
 <p><b>JZ-10009</b> HSH-7.94BG KHS12-S 7.94mm</p> <p>For: <b>BROTHER</b> DB2-B714-3.B753.B795-013 <b>JUKI</b> DDL-127.227.541.555.5550 <b>MITSUBISHI</b> DB-126-10.130G-10.171 LS2-1130-M.MOB-150-MOB <b>SINGER</b> 281-81.83.366.400W 600W <b>TOYOTA</b> AD148.156.345.352.D146.347.352 <b>JANOME</b> DB-J701~4.J707~8 (gold base)</p>	 <p><b>JZ-10010</b> HPF-134/ZSK KHS12-S 7.24mm</p>	 <p><b>JZ-10025</b> HPF-335 KHS12-S 7.24mm</p> <p>For: <b>PFAFF</b> 138.234.331.333.335.337-734</p>	 <p><b>JZ-10026</b> HSH-31(6) KRT31-NR 7.93mm</p> <p>For: <b>YAKUMO</b> 981.982 <b>GOLDEN WHEEL</b> CS-810.820 <b>NITAKA</b> TC-810S.820S <b>SUNSTAR</b> KM-867.KPW-827B</p>
 <p><b>JZ-10011</b> HSH-7.94B KHS12-S 7.94mm</p> <p>For: <b>BROTHER</b> DB2-B714-3.B753.B795-013 <b>JUKI</b> DDL-127.227.541.555.5550 <b>MITSUBISHI</b> DB-126-10.130G-10.171 LS2-1130-M.MOB-150-MOB <b>SINGER</b> 281-81.83.366.400W 600W <b>TOYOTA</b> AD148.156.345.352.D146.347.352 <b>JANOME</b> DB-J701~4.J707~8</p>	 <p><b>JZ-10012</b> HSM-A(MQTS) KHS20-RYN 7.94mm</p> <p>For: <b>TAJIMA</b> 6-7TS TMFD-C.TMFX-C TMLE.TMLG. (Large hook.teflon base)</p>	 <p><b>JZ-10027</b> HPF-335(5) KR69-V 7.24mm</p> <p>For: <b>SEIKO</b> LSC-8B.8BV <b>CONSEW</b> 277R.277RFS</p>	 <p><b>JZ-10028</b> HPF-390 KRT390G 7.925mm</p> <p>For: <b>PFAFF</b> 390</p>
 <p><b>JZ-10013</b> HSH-7.94ATR KHS12-RP 7.94mm</p> <p>For: <b>ABLE</b> HB-300 <b>CHUAN NENG</b> CN-991.992</p>	 <p><b>JZ-10014</b> HSM-ATR(MTQTS) KHS20-RYPN 7.94mm</p> <p>For: <b>TAJIMA</b> 6-7TRTS TMFD-C.TMFX-C TMLE.TMLG. (Large hook.teflon base) (under trimming machine)</p>	 <p><b>JZ-10029</b> HPF-490 KRT470-S 7.92mm</p> <p>For: <b>PFAFF</b> 471-493 <b>SEIKO</b> PWB-22GW-8W</p>	 <p><b>JZ-10030</b> KRT341-NR 341HR 7.93mm</p> <p><b>HYM-341AY</b> For: <b>JUKI</b> 21229752W/GAP LS-341N <b>MITSUBISHI</b> LY3-6840-BOT <b>GOLDEN WHEEL</b> CS-8233-NR,8243</p>
 <p><b>JZ-10015</b> HSH-7.94BTR KHS12-SP 7.94mm</p> <p>For: <b>JANOME</b> DB-J709 <b>JUKI</b> DDL-500.DLD-432-2.DMN-530 <b>TOYOTA</b> AD157-623.-666.AD157A-622 <b>CONSEW</b> 290RATCW.290RTC.290RTCW <b>ABLE</b> HBS-2700 <b>SUNSTAR</b> KM-235A <b>NAKAJIMA</b> 178Y-2</p>	 <p><b>JZ-10016</b> HSM-B1H KHS20-GTB 7.94mm</p> <p>For: <b>BROTHER</b> DB2-B745-5 <b>JUKI</b> DDL-201H <b>MITSUBISHI</b> DY330-22D.337-2S <b>ABLE</b> HB-380 <b>TYPICAL</b> GC6-5</p>	 <p><b>JZ-10031</b> HPF-490(A) KRT470-R 7.92mm</p> <p>For: <b>PFAFF</b> 471-493 <b>SEIKO</b> PWB-8GW (short gib)</p>	 <p><b>JZ-10032</b> DP2-NJ KRP41-LH 7.94mm</p> <p>For: <b>JUKI</b> LBH-761.762.763 <b>DALIAN</b> G13 <b>HUANAN(SOUTH CHINA)</b> G16-1 <b>SHANGGONG</b> G15 <b>SUNGOOD</b> GF11001</p>



<p>JZ-10033 DP2-NJ771 KRP771</p>  <p>7.94mm</p> <p>For: <b>JUKI</b> LBH-771-774.781-784 <b>K-CHANCE</b> KBH-890 <b>TAKING</b> TK-888 <b>DALIAN</b> G18</p>	<p>JZ-10034 HSH-12-15L KRT12-5B</p>  <p>9.52mm</p> <p>For: <b>BROTHER</b> LT2-831-1.3B832-1.3B833 <b>SEIKO</b> LTW-26.27.27B.27BM <b>NITAKA</b> TC2-B842 <b>SUNSTAR</b> KM2-740B</p>
---	---



<p>JZ-10035 DP2-LB KRP41-B</p>  <p>7.93mm</p> <p>For: <b>BROTHER</b> LH4-B814</p>	<p>JZ-10036 HSH-12-15L(H) KRT12-5BHR</p>  <p>9.52mm</p> <p>For: <b>BROTHER</b> LT2-B831-5.B832-5 (heavy materials)</p>
--	---

<p>JZ-10037 DP2 KRP41-S</p>  <p>7.93mm</p> <p>For: <b>PEGASUS</b> DPS-2.3.150 <b>YAMATO</b> DP2.3 <b>SINGER</b> 107G.107W1.107W5.17 <b>ADLER</b> 91.98 <b>DURKOPP</b> 252.253.254.255.264 <b>SUNSTAR</b> DPK-2</p>	<p>JZ-10038 HSH-12-15LC KRT12-5BK</p>  <p>9.52mm</p> <p>For: <b>BROTHER</b> LT2-B835-3.5.800 <b>SEIKO</b> LTW-27BK <b>CONSEW</b> 327R-1 (corner sewing machine)</p>
---	--

<p>JZ-10039 DP2-815</p>  <p>7.94mm</p> <p>For: <b>BROTHER</b> LH4-B815 BAS-500</p>	<p>JZ-10040 HG12-15L(TRI)</p>  <p>9.52mm</p> <p>For: <b>BROTHER</b> LT2-B842 (under trimming machine)</p>
--	---

<p>JZ-10041 DP2-57(2) KRP 457</p>  <p>7.94mm</p> <p>For: <b>MITSUBISHI</b> LZ720-780 <b>SINGER</b> 457G <b>YULUN</b> 547U205.225</p>	<p>JZ-10042 HG12-15L(H) KRT842H-S</p>  <p>9.52mm</p> <p>For: <b>BROTHER</b> LT2-B841-5.B842-5 (heavy materials)</p>
---	--

<p>JZ-10043 DP2-57(2LP) KRP457-W</p>  <p>7.94mm</p> <p>For: <b>SINGER</b> 457G <b>YULUN</b> 547U435L (long hook point)</p>	<p>JZ-10044 HG12-15LC KRT845BK</p>  <p>9.52mm</p> <p>For: <b>BROTHER</b> LT2-B845</p>
---	--

<p>JZ-10045 HSH-11-55 KRT11-5</p>  <p>9.52mm</p> <p>For: <b>JUKI</b> LU-53.55.562 <b>SEIKO</b> STW-6.7.7B.8.8B.8BV.8M.8BM.8V 8VM.8VP.8VPM.8BVP <b>SINGER</b> 111W155.156.211G155.156 211U165.166.211U365/6.211W151. 155 <b>CONSEW</b> 137.139R-1.224R-1.225VMG. 266RVM-1 (slotted shank)</p>	<p>JZ-10046-A 3568</p>  <p>For: <b>JUKI</b> 3568</p>
---	---

<p>JZ-10047 HSH-12-15 KRT12-5S</p>  <p>9.52mm</p> <p>For: <b>JUKI</b> LH-51.51-10 LH-516.517.518.LU-53-7.562A <b>SINGER</b> 112W115-139</p>	<p>JZ-10048 HSH-12-15M KRT12-5M</p>  <p>9.52mm</p> <p>For: <b>MITSUBISHI</b> DN-260.260-10 DN-265.265-10 LT2-220-M.2220M.220.2220.L <b>UNICORN</b> LT2-H320.H321 <b>ABLE</b> LT2-220ML</p>
--	---

<p>JZ-10049 HSH-12C KRT12-5MK</p>  <p>9.52mm</p> <p>For: <b>MITSUBISHI</b> DN-275-10.10K <b>TAJIMA</b> TMP-20 <b>UNICORN</b> LT2-H240-MOB (corner sewing machine)</p>	<p>JZ-10050 HSH-12-15MM KRT12-5LM</p>  <p>9.52mm</p> <p>For: <b>MITSUBISHI</b> DN260-22.262.265-22.267 LT2-220-B.220-BOB.2220-B 2220-BOB <b>NITAKA</b> TC-B872 <b>ABLE</b> LT2-220BF</p>
--	---



<p>JZ-10051 HSH-12(2) KRT12-5J</p>  <p>9.52mm</p> <p>For: <b>JUKI</b> LH-1152 <b>SUNGOOD</b> GC0501</p>	<p>JZ-10052 HSH-12MC KRT12-5LMK</p>  <p>9.52mm</p> <p>For: <b>MITSUBISHI</b> DN-275-20.LT2-240-B.2240-B <b>NITAKA</b> TC2-B875 <b>SICAMA(TASICO)</b>LT2-B875 <b>UNICORN</b> LT2-H240-BOB (corner sewing machine)</p>
--	---



<p>JZ-10053 HSH-12-15(2)TR KRT12-5JCI</p>  <p>9.52mm</p> <p>For: <b>JUKI</b> LH-1152-4.5 (under trimming machine)</p>	<p>JZ-10054 HSH-12-15MMJ KRT11-5LJS</p>  <p>9.52mm</p> <p>For: <b>JUKI</b> LU-563 (slotted shank)</p>
--	--

<p>JZ-10055 HSH-12-62C(L) KRT12-5JK3-L</p>  <p>9.52mm</p> <p>For: <b>JUKI</b> LH-1162 <b>SICAMA(TASICO)</b>SC-1162-5 (left hand)</p>	<p>JZ-10056 HSH-12-15MMJ(A) KRT11-5LJR</p>  <p>9.52mm</p> <p>For: <b>JUKI</b> LU-563-3.LUH-520 <b>YAKUMO</b> 481L.482L <b>SINGER</b> 212U539A.839A 211U567A.867A.211U867 <b>EAGLE</b> EA-156RB (short gib.slotted shank)</p>
--	--

<p>JZ-10057 HSH-12-62C(R) KRT12-5JK3-R</p>  <p>9.52mm</p> <p>For: <b>JUKI</b> LH-1162 <b>SICAMA(TASICO)</b>SC-1162-5 (right hand)</p>	<p>JZ-10058 HSH-12-15MM(5) KRT-LS2-R</p>  <p>9.52mm</p> <p>For: <b>BROTHER</b> LT2-B837 <b>SEIKO</b> LLW-7L.7BL.8L.8BL.LSW-6L 7L.7L-TA.LLWH-7L-TA 8L-TA.28BL-TA <b>TOYOTA</b> AD331L.331LP.332L.332LP <b>CONSEW</b> 244B.254B.255RB.333R.339R.</p>
--	---

<p>JZ-10059 HSH-12M-82C(L) KRT12-5LJK3-L</p>  <p>9.52mm</p> <p>For: <b>JUKI</b> LH-1182 <b>SICAMA(TASICO)</b>SC-1182-5 <b>SHANGGONG</b> GD8-7 (left hand)</p>	<p>JZ-10060 HSH-12-15MMB(5) KRT-LS2-S</p>  <p>9.52mm</p> <p>For: <b>BROTHER</b> LT2-B838 <b>SEIKO</b> LLW-27BL.27BL.28.28L.28BL LSW-27L.27BL.27BLM.28L. LTW-27BLM <b>CONSEW</b> 333B.333RB-1.339.RB-1. 333RBL-1 (full gib.slotted shank)</p>
--	---

<p>JZ-10061 HSH-12M-82C(R) KRT12-5LJK3-R</p>  <p>9.52mm</p> <p>For: <b>JUKI</b> LH-1182 <b>SICAMA(TASICO)</b>SC-1182-5 <b>SHANGGONG</b> GD8-7 (right hand)</p>	<p>JZ-10062 HG12M(BR) KRT872L</p>  <p>9.52mm</p> <p>For: <b>BROTHER</b> LT2-B872</p>
---	---

<p>JZ-10063 HSH-12-15MM(V) KRT12-5LMC</p>  <p>9.52mm</p> <p>For: <b>MITSUBISHI</b> DU-100-22.105-22.107.120-22 122.125-22.127.LU2-400B 420-BOB.4400.4420 (slotted shank)</p>	<p>JZ-10064 HG12MC(1) KRT875LK</p>  <p>9.52mm</p> <p>For: <b>BROTHER</b> LT2-B875</p>
---	--



















	JZ-10065	HPF-3114		JZ-10096	1.6倍 1.6 times the capacity
FOR: PFAFF 114,3114,3115					
	JZ-10067	DP2-NG(790)		JZ-10068	H12MC(2) 3188TR
FOR: JUKI LBH 1790			FOR: JUKI LH3178-7,3128-7,3188-7		
	JZ-10069	2290		JZ-10070	1720
FOR: JUKI LZ 1280,2280 ,2290			JUKI GOLDENWHEEL CSL-1720		
	JZ-10071	818 DPR-818F2		JZ-10072	HPF-151
FOR: JUKI 818			FOR: PFAFF 120,122,141-146,142-720, 151,175-196,191-196,871-893		
	JZ-10073	HPF-145		JZ-10074	HPF-591
FOR: PFAFF 91-010850-91 W/O CA,141-146, 175-196,871-893			FOR: PFAFF 591		
	JZ-10075	HPF-1242		JZ-10076	HPF-545
FOR: PFAFF 91-140539-91 W/O CAP, 1242-720,1244-748			FOR: PFAFF 541-546,551-555,591-596, 542-720(large capacity hook,full.gib)		
	JZ-10077	241		JZ-10078	6-30
FOR: FENG YING FY-241-246-246V			FOR: TYPICAL GC6-30		
	JZ-10079			JZ-10081	380 HSM-B(SU) KHS20-GTVG
FOR: TYPICAL GC6-20			FOR: SUNSTAR KM-380BL		

	JZ-10082	557 KRT211-L		JZ-10097	484 3倍 3 times the capacity
HSH-12-15MM(S) FOR: SINGER 211G557,558,556, 211U566,211G*104, 106,109,114,117, 212G539,541, 212G*2,106,114 (large capacity hook)					
	JZ-10084	HPF-1242TR		JZ-10085	KRT545-S HPF-545(B)
FOR: PFAFF 1242-720,1244-748			FOR: PFAFF 541-546,551-555 591-596,544-720		
	JZ-10086	KPT341-NH		JZ-10088	KRT19-R HSH-19
FOR: NITAKA TC-341-L TC8370L,8371L,8372L, 8872L,9510L,9511L,6520L			FOR: SINGER 110W-2,119W		
	JZ-10090	KRT8-BL HSH-31MMB(S)		JZ-10120	HSH-7.94BOHNTR(B)
FOR: SEIKO 13719 LCW-28BL,-8BL SUNSTAR KM-390BL					
	JZ-10121	768		JZ-10095	3823
	JZ-10080	253 HSH-32		JZ-10092	132 KRT-132
FOR: SEIKO SKM-26,36, SINGER 133K			FOR: MITSUBISHI MG23E0121 SEIKO 1343C SK-2B,-6,-6F SINGER 103123 132K CONSEW SK-6,-7,-8 DURKOPP ADLER 265-21-142 265 GOLDER WHEEL CS-6500,6501,CSL-1800,1801		
	JZ-10093	133		JZ-10094	132M KRT-132-M
HSH-33 KRT133  FOR: SEIKO 2530 CK-1 SINGER 103120 133K			FOR: SEIKO 1526 SKM-26,-36		



	JZ-10122 HPF-438		JZ-10123 HPF-418
	JZ-10124 HDU-271		JZ-10125 HSM-A(5)
	JZ-10126 245		JZ-10127 246
	JZ-10128 380 (小)		JZ-10129 D530-1
	JZ-10130 697		JZ-10131 592
	JZ-10132 HPF-591G		JZ-10133 HF-12MC(2)TR
	JZ-10134 HAD-167		JZ-10135 HF-12MM(2)TR
	JZ-10136 467TR		JZ-10137 HF-12MC(2)

	JZ-10301 BC-31-15		JZ-10302 BC-DBZ(3)-NBL (12mm Opening) For:ELTAC 750 series SINGER 20U TAJIMA
	JZ-10303 BC-LK(B2) With NBL-101 Spring For:BROTHER LK3-B430.-B431.-B432.-B433-B434 -B435.-B438.BAS-303~330 BAS-555		JZ-10304 BC-457(NS) For:CONSEW 347.375R.376R JUKI LZ-1285.-1286.-1287 MITSUBISHI LZ-720-11 BROTHER LZ2-B852.-853.-854 SINGER 457G.457U STAGER DZ-S31.SZ-310 TOYOTA AD550.A551
	JZ-10305 BC-LK(J3) For:JUKI AMS-210A.-12A.LK-1850		JZ-10306 BC-LBH771 For:JUKI LBH-771.-772.-773.-781~4
	JZ-10307 BC--DB1 For:ADLER.BROTHER.CONSEW. HUSQVARNA.JANOME.JUKI. MITSUBISHI.NECCHI.RICCAR. TOYOTA.YAKUMO.YASIMA SINGER 95.96.103.188U.195K.196K.245		JZ-10308 BC-DBM(1) For:BROTHER D82B745-7.B797-5 TAJIMA TMB-E.TMB-W.TMW JUKI DDL-201S YAKUMO DBU-175L-3 CHINA GC6-7
	JZ-10309 BC--DB1-NBL1 Whit NBL-1303 Spring For:ADLER.BROTHER.CONSEW. HUSQVARNA.JANOME.JUKI. MITSUBISHI.NECCHI.RICCAR. TOYOTA.YAKUMO.YASIMA SINGER 95.96.103.188U.195K.196K.245		JZ-10310 BC-DBM(1)NBL3 Whit NBL-1303 Spring For:BROTHER D82B745-7.B797-5 TAJIMA TMB-E.TMB-W.TMW JUKI DDL-201S YAKUMO DBU-175L-3 CHINA GC6-7
	JZ-10311 BC--DBZ (1) (18mm Opening) For:ADLER 199.289.489 BARUDAN.BROTHER TZ1.LE2.BAS-400 JUKI LZ(except-405.-407.-581.-582.-583 -586.-1280.-1286.-1287) NECCHI 533.535.720.721 STAGER DZ.SZ(except DZ-S31.SZ-21-1B -5.-310)		JZ-10312 BC-6-5 For:BROTHER DB2-B745-5 JUKI DDL-210H MITSUBISHI DB-325-22D.DY330-22D TOYOTA D530-130.140 YAKUMO DBU-175L-1/1.680L CHINA GC6-5.6-6.6-9
	JZ-10313 BC-DBM(2)-NBL1 HSM-A(5) Whit NBL- 241 Spring For:CONSEW 206RB.208RB JUKI DNU-241H SEIKO STH-3BL.-7BL.-8BL YAKUWMO 280L.880LM		JZ-10314 BC-PF9076(14) (14mm Opening) For:PFUFF 130.138.230.238.335 SEIKO LSC-8BVC
	JZ-10315 BC-DBM(Z2)-NBL For:TAJIMA		JZ-10316 CP-12C(835) For:BROTHER LT2-B835-3.5.800 JUKI LH-528 CONSEW 327R-1 TAJIMA TMP-20 ABLE HB-630 (corner sewing machine)





**JZ-10317** BC-PF9076  
 (9mm Opening)  
 For: **PFAFF** 133.134.232.234.260.300.331.332  
 333.341.343.360.432.433.434.437  
 438.439.461.463.465.467.481.483  
 485.487.489  
**SEIKO** LSC-8B.-8BV  
**ADLER** 069  
**CONSEW** 277



**JZ-10318** CP-G12C(845)  
 For: **BROTHER** LT2-B845  
**SUNSTAR** KM-490



**JZ-10319** BC-HA1  
 For: **SINGER** 15k88.90.91



**JZ-10320** CP-62C(1162)  
 For: **JUKI** LH-1162.1162-4.5  
**SICAMA(TASICO)** SC-1162-5.6  
 (whit bobbin thread control spring)



**JZ-10322** CP-M82C(1182)  
 For: **JUKI** LH-1182.1182-4.5  
**SICAMA(TASICO)** SC-1182-5.6  
 (large capacity cap with bobbin thread control spring)



**JZ-10323** BC-107(2)-NBL 814  
 With NBL-603 Spring.  
 For: **ADLER.BROTHER.CONSEW.DURKOPP.**  
**JULI.MITSUBISHI.PEGASUS.YAMATO.**  
**SINGER** 107G.107W3.14.15.50.143W1.2.3.  
 18.307G2.



**JZ-10324** CP-G12MC(1)(875)  
 For: **BROTHER** LT2B875  
**SUNSTAR** KM-790-BL



**JZ-10325** SC205H  
 For: **JUKI** AMS220



**JZ-10327** BC-310A  
 For: **BROTHER**.BAS.-304.310.311.314.326.  
 341.701  
 (thin material)



**JZ-10328** CP-HPF151(10159)  
 For: **PFAFF**.151  
**GOLDEN WHEEL** CS-861.862.8810.8820  
**YAKUMO** 561-564



**JZ-10330** BC-DBZ (1) -NBL6  
 With NBL-406 Spring  
 For: **ADLER** 199.289.489  
**BARUDAN.BROTHER** TZ1.LE2.BAS-400  
**JUKI** LZ(except-405.-407.-581.-582.-583  
 -586.-1280.-1286.-1287)  
**NECCHI** 533.535.720.721  
**STAGER** DZ.SZ(except DZ-S31.SZ-21-1B  
 -5.-310)



**JZ-10331** BC-HZ3(NS)  
 (12.3mm slot)  
 With Ns tension spring  
**SINGER** 307



**JZ-10332** BC-DBZ(2)  
 (18MM OPENING)  
 FOR : **JUKI** LZ-586



**JZ-10331-2** 307 Two hole  
**SINGER** 307



**JZ-10334** LS-341  
 For: **PFAFF** 1242-720B. C. D 1242-74B  
 B. C. D 1244-720 B544-720 B. D.  
 551-555 (S L) 551-553 (SL)

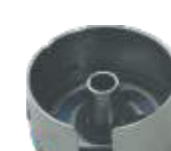

**JZ-10335** BC-DBM(Z1)NBL3  
 FOR: **CONSEW** 175. 176. **ELTAC** 900.1800  
 SERIES SZ-21-1B. -21-5  
**TOYOTA** D530,-18E, -30P, -101, -110,-120  
**SEIKO** LZH,EVL



**JZ-10336** CP-M697  
 FOR: **DURKOPP** 697



**JZ-10337** 181  
 FOR: **MITSUBISHI** PLK-A1710



**JZ-10338** CP-G12MC(1)TR  
 S09280-001TR



**JZ-10339** BC-DB1(G)  
**GOLD HANDER**



**JZ-10340** BC-PF3114  
 FOR: **PFAFF** 144, 155, 116, 3114, 3116



**JZ-10343** BC-9076(TG)-NBL6  
**PFAFF/DUPKOPP** TYPE  
 WITH NBL-806 SPRING  
 FOR: **PFAFF**



**JZ-10351** LH-1152  
 FOR: **JUKI** LH-1152



**JZ-10352** LH-527 CP-12MC  
 FOR: **JUKI** LH-527,LUH-521,526,527  
**MITSUBISHI**,  
 DN-275-20,  
**CORNER SEWING MACHINE LIARGE**  
**CAPACITY CAP**



**JZ-10353** LZ-2280  
 FOR: LZ-2280 **GOLDEN WHEEL** S-2200



**JZ-10354** LBH-790  
 FOR: **JUKI** LBH-790 137-29769



**JZ-10355** 1.7倍大



**JZ-10356** CP-HPF144TR  
 FOR: **PFAFF**. 144  
**GOLDEN WHEEL** CS-61118.T.BT  
 CS-61128.T.BT  
**SEIKO** PWB-8GWC.FLLC  
**SUNSTRA** KM-867-7



**JZ-10357** DDL-545  
 FOR: **PFAFF**



**JZ-10358** 双丝机1720  
 FOR: **SINGER**110W,118W,119W,236W,  
**GOLDEN WHEEL** CSL-1720











**JZ-10359** 810内斧  
 FOR: **HOOK** 810,820



**JZ-10360** 526  
 FOR: **LU**-1565,LUH-521,LUH-526



	JZ-10364	210D	SC-180S	FOR: JUKI LK1910,1920,1930,AMS-210D		JZ-10365	SINGER 反向	125291	125291
	JZ-10367			FOR:BC-DB1-NBL6 SPRING BC-DB1-8		JZ-10368			
	JZ-10369	BC-1306		SPS-B1306		JZ-10371	3倍	BC-HST(2)	FOR:JUKI LK-1941 3 times the capacity
	JZ-10374		BC-DBM(22)-NBL3	BC-DBM(Z2)-NBL3 WITH NBL FOR:TAJIMA		JZ-10378	845TR	CP-G12C-TR	FOR:BROTHER LT2-B845
	JZ-10380		BC-6-5-NBL	BC-DBM-NBL3 WITH NBL FOR:BROTHER DB2-B745-5 JUKI DDL-210H		JZ-10381		BC-457-NBL	
	JZ-10382		BC-LBH771-NBL	WITH NBL FOR:JUKI LBH-771,-772, -773,-781-4		JZ-10383	591		
	JZ-10384		BC-NJ380			JZ-10385	245	CP-M245	DMN-530-4 B1837 041 OAO
	JZ-10386	761	BC-107(2)	FOR:JUKI LBH761-763		JZ-10389	1.6倍		1.6 times the capacity

	JZ-10390	168				JZ-10391	2600大斧		
	JZ-10392	2600摆梭				JZ-10393	588大斧		
	JZ-10394	588摆梭				JZ-10395	3823		
	JZ-10396			开袋机梭壳 (大)		JZ-10397			开袋机梭壳 (小)

严格通过近20多道程序检测，在抗耐磨，防卡线，间隙小，低噪音上表现出的品质尤为突出。

为此我们郑重承诺：凡购买后3个月内出现的质量问题包退包换。

JINZEN hook has passed through 20 detections, and have these outstanding advantages, such as wear resistance, avoiding the thread winded, small gap, low voice.

Hereby we make a solemn commitment that all

JINZEN products sold on approval if any quality problems in 3 months.







JZ-10601 JZ-10602 JZ-10603 JZ-10604 JZ-10605 JZ-10606 JZ-10607  
 JZ-10608 JZ-10609 JZ-10610 JZ-10611 JZ-10612  
 JZ-10613 JZ-10614 JZ-10615 JZ-10616 JZ-10617



JZ-10618 JZ-10619 JZ-10620 JZ-10621  
 JZ-10622 JZ-10623 JZ-10624 JZ-10625



F7 梭 JZ-10626 F6 梭 JZ-10627 4# 梭 JZ-10628 ZS 梭 JZ-10629 ZS街缝梭 JZ-10630  
 丽绣钢梭 JZ-10631 9# 梭 JZ-10632 苏拉碳梭 JZ-10633 苏拉铸梭 JZ-10634  
 平冈(大金) JZ-10635 平冈(进口) JZ-10636 丽绣碳梭 JZ-10637 丽绣铸梭 JZ-10638

JINZEN  
梭



JINZEN®

JZ-10800  
BLACK DIAMOND



HSB-7-3 KSP7-31 JZ-10680 GB4-1A JZ-10681 GB4-1 JZ-10682 KSP-204N JZ-10683 GA5-1 JZ-10702  
 421326 SINGER 974 JZ-10701 2600 JZ-10366 2972 JZ-10697 2971 JZ-10698 HPF-5870 JZ-10699 HPF-28 JZ-10700 GA3-1 JZ-10703  
 210E JZ-10704 210D JZ-10705 430D JZ-10706 SH-181 JZ-10707 SH-280 1850 JZ-10708 430 JZ-10709  
 SH205 JZ-10711 SH311 JZ-10712 430H A/B JZ-10713 1306 JZ-10714 JAH 105 JZ-10717 125293 JZ-10718  
 多功能家用机307 JZ-10719 210ENC JZ-10720 125292 反向 JZ-10721 6560 JZ-10722 430F JZ-10723 210D(台湾) JZ-10724 210EN(B) JZ-10725



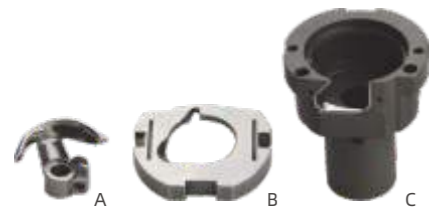

JZ-10801 1850



JZ-10802 1900



JZ-10803 MITSUBISHI  
2520



JZ-10804 430D



JZ-10805 1900A



JZ-10806 210D

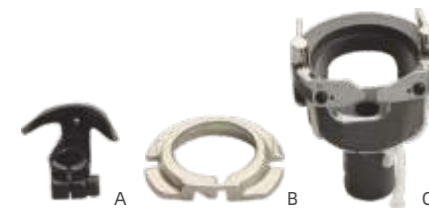

JZ-10807 430



JZ-10808 430E小孔8.0



JZ-10809 311EL



JZ-10810 430E大孔9.6



JZ-10811 430F



JZ-10812 430D小孔8.0



JZ-10813 SUNSTAR



JZ-10814 MITSUBISHI  
A1006

**JINZEN®**

# JINZEN® BOBBINS



JA1-1



974



136492



163131



506417



JZ-10901 Singer



JZ-10902 JANOME



312954



3129565

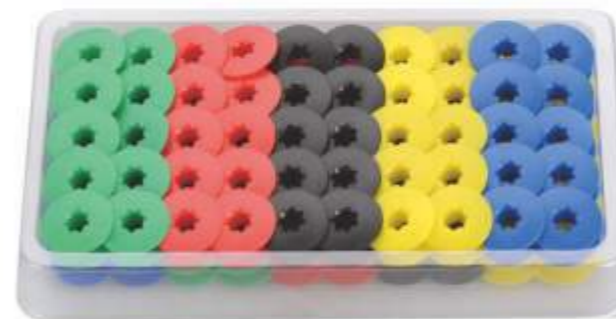

JZ-10903 Plastic



JZ-10904 AL



# JINZEN® BOBBINS



272152A



272152L



203470A



B1809-761-000A



18034A-B



50006-03



杜克普  $\phi$  22 26 32mm  
0246003058



40264A



272152Y



10079A



146025-001(814)



18034A



B1805-205-000  
(1900A)



3823



591



55623A



272152G



B1827-280-000  
(2996A)



B1811-771-000A



515665-001  
(430D)



138-12102  
(210D)



400-66272 开袋机



233939



55623AS



272152R



9033A



771Y



155484-001(1182)



3倍 (3TIMS)



1.6倍 (1.6TIMS)



272152A2



272152B



91-174480



771B



509285-001(1182 3孔)



400-22188



9910



270010



40264



55623



172222



55623-H



18034



155484-001



GA5-1



270010S



40264B



55623S



112781-101



55623S-H



18034B



263099



204



270010S-深



2996A



55623B



9033



270010S-H



B9117-201-000



150971-001-4



GB4-1



40264NS



20518



10079



203470



270010-H



B9117-563-000



150971-001-2



5810



2518



40264(2HG)-H



1.6倍 (1.6TIMS)



203470B



18034-H



B9117-563-00-B



500871-1



97949





JZ-11201  
other size can be manufactured  
可订制各种规格

**JINZEN**® BAND KNIFE  
JINZEN STRAIGHT KNIFE AVAILABLE SIZE

2200mm	2450mm	2800mm	2950mm	3000mm	3460mm
3500mm	3550mm	3555mm	3600mm	3650mm	3680mm
3700mm	3850mm	3860mm	3920mm	3960mm	4000mm
4050mm	4120mm	4150mm	4220mm	4250mm	4350mm
4450mm	4460mm	4500mm	4550mm	4560mm	4630mm
4760mm	4720mm	4870mm	4920mm	4950mm	5280mm
5360mm	5420mm	5480mm	5500mm	5650mm	5940mm

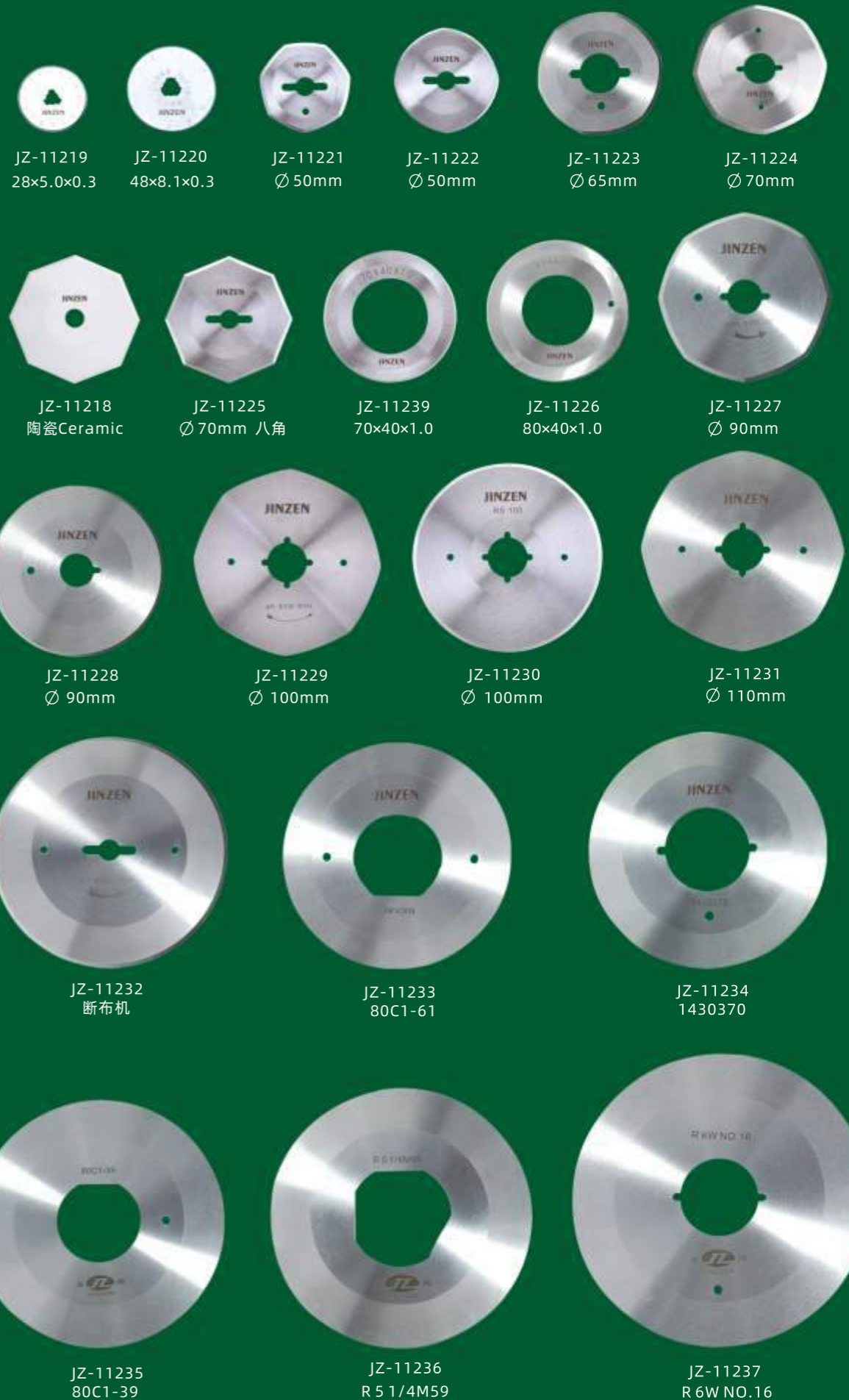



# JINZEN®

来自台湾的品质  
Quality from Taiwan



## AAAAA

高速钢

## AAA

合金钢

采用进口SKS7、M2高速钢以及SK2合金钢，  
采用目前最先进的生产工艺流程，配套有国内顶级的热处理设备，  
目前品种已达上千种，每个通过高精度检测影像仪器严格检测。

JINZEN knife Use imported SKS7 M2 high speed steel and SK2 alloy,  
with the most advanced production processes, top domestic heat treatment equipments,  
and so far already have more than 1000 types.  
Each knife has inspected under high-precision detective imaging device.



JZ-11300 合金钢

- 1/4
- 5/16
- 3/8
- 7/16
- 1/2
- 9/16
- 5/8
- 3/4
- 7/8
- 1"
- 1-1/8
- 1-3/16
- 1-3/8
- 1-1/2



JZ-11302 高速钢

JZ-58085 AAA



JZ-11301 AAAAA



5E 6E



JZ-11308 5E 6E 7E 8E 9E 10E 12E 13E AAAAA  
JZ-11309 5EW 6EW 7EW 8EW 9EW 10EW 12EW 13EW AAAAA



JZ-11304



JZ-11305

JZ-11305 SIZE: 5E 6E 7E 8E 9E 10E 12E 13E AAA

JZ-11304 SIZE: 5EW 6EW 7EW 8EW 9EW 10EW 12EW 13EW AAA



JZ-11306



JINZEN®



有一种力量叫

## 品牌

多年来，

不管市场环境如何变化，

金振的产品总是随着市场应运而生。

除了质量、工艺之外，

不可否认，更离不开金振人的热情服务！









CR26 CRL 103 C007J 425/6-4 111114-0-01 111113-0-01 B2421-210-000 B2421-210-AA0



象王/金轮 高头车固定刀 SA3335-001 SB1191-001 0271-001497 JZ-11351 548848 D2713 SB0598-001



MF-40A1834 MG4080834 MF-40A1835 MG4080835 0271-001483 MF-40A2180



179459-05 S03627-001 JZ-11352 S001701-0-01 JZ-11353 179458-05 S07525-000



40015996 301006 MAT-022040000 RU10 110-42652 D2408-555-CA0



SA6989-001 S37672-101 S37671-101 S37675-101 S37676-101 32020505



13-1241-377-0A0 S49988-001 MS03B0838 HV270080 FX0206010000DD FX0227000000 SA3330-101



110-95403 400-25949 G5409-254-000 141509-101 S19824-001 S50404-301

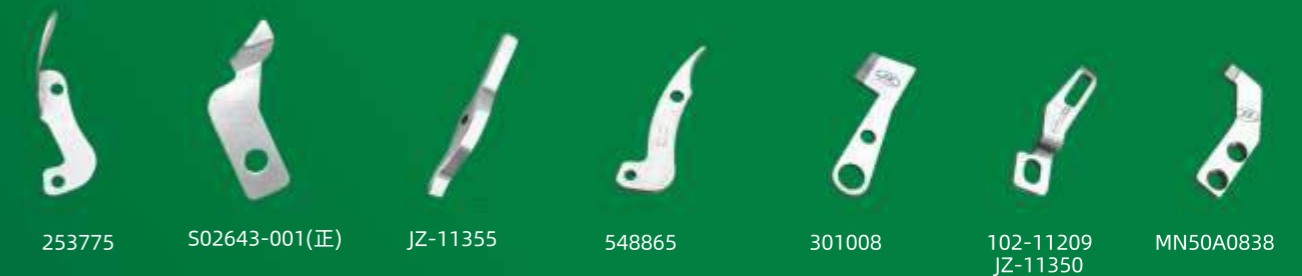

253775 S02643-001(正) JZ-11355 548865 301008 102-11209 JZ-11350 MN50A0838



MG52A0838 MF02A0838 A-B2111417-556 10-001A-2700 716-154468-0-01 181LY-B110522020 S02637-001



MG52A0834 MF02A0834 154575-0-01 MF00A0834 S02646-001 S02645-001



91-264240-05 2111417-553-A 2111407-553-B 02520172-145-A-B 10-106A-2700 KM-250 181LY-B115421010



# OUR QUALITY, YOUR TRUST

JINZEN®











JZ-11402



JZ-11401



Glove Size	Size Number	Color Code	Traditional Glove Size	Hand Circumference
XXS	00	Brown	5 - 5.5	127 mm
XS	0	Green	6 - 6.5	152 mm
S	1	White	7 - 7.5	178 mm
M	2	Red	8 - 8.5	203 mm
L	3	Blue	9 - 9.5	229 mm
XL	4	Orange	10 - 10.5	254 mm



JZ-11422



JZ-11423



JZ-11424



JZ-11425



JZ-11426



JZ-11427



JZ-11428



JZ-11429



JZ-11430



JZ-11431



JZ-11432

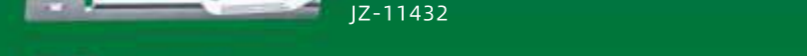

JZ-11433



JZ-11421



JZ-11434

- 71 1/8
- 71 1/4
- 71 5/16
- 71 3/8
- 71 7/16
- 71 1/2
- 71 9/16
- 71 5/8
- 71 11/16
- 71 3/4
- 71 13/16
- 71 7/8
- 71 15/16
- 71 1
- 71 1-1/16
- 71 1-1/8
- 71 1-3/16
- 71 1-1/4
- 71 1-3/8
- 71 1-1/2



JZ-11435



JZ-11436



JZ-11437



JZ-11438



JZ-11439



JZ-11440



JZ-11441



JZ-11448



JZ-11449



JZ-11450



JZ-11452



JZ-11442



JZ-11443



JZ-11445



JZ-11446



JZ-11447



JZ-11452





JZ-11500

**JINZEN®** High quality Needle

**机针型号:**

**用途:**

- DB×1 ----- 平车 lock stitch
- DB×K5 ----- 绣花机 embroidery stitch
- DP×5(135×5) ----- 锁眼及曲折缝机 buttonholing ,zig-zag sewing
- DC×1 ----- 包缝机overlock
- DC×1NS ----- 包缝防起皱overlock for new synthetic material
- DC×1KN ----- 包缝针织布料 overlock for knitted fabric
- DC×27 (B27) ----- 高速包缝 highspeed overlock
- DP×17(135×17) ----- 厚料机 lock stitch for thicker material
- UY×128GAS (DV×43) ----- 绷缝 2-3needles double chain stitch
- DV×1(UY121GS) ----- 绷缝 2needles double chain stitch
- TQ×1 ----- 钉扣 button sewing
- TQ×7 ----- 钉扣 button sewing
- TV×7 ----- 镶边/折缝 hemming ,felled seam
- TV×5 ----- 折缝,felled seam
- UN×154 ----- 弯针包缝 curved overlock needle
- DM×13 ----- 安全缝纫 interlock
- DO×5 ----- 圆头锁眼机eyelet buttonholing
- UO113GS ----- 橡筋车用 smocking ,double chain stitch
- LW×5T ----- 盲绕缝 blind stitch
- LW×6T ----- 折缝 盲缝 felled seam, blind stitch
- PF×134LR ----- 皮革用斜切刀针45°
- SH×1 ----- 大型电绣机针 (蕾丝针) schiffli needle (for large automatic embroidery machine)
- SH×3 ----- 大型电绣机针 (蕾丝针) schiffli needle (for large automatic embroidery machine)
- SH×3TOP ----- 加长型 longer type of SH\*3
- CP×12 ----- 珠边机pin-point sewing
- HA×1 ----- 家用机针 for domestic sewing machine

**JINZEN®**

**SIZE:**

55	60	65	70	75	80	85	90	100	110	120	125	130	140	160	180	200
7	8	9	10	11	12	13	14	16	18	19	20	21	22	23	24	25



大鼻针 Crewels Plain Eyed

JZ-11501



JZ-11514



JZ-11515



JZ-11516



JZ-11517



JZ-11502



JZ-11503



JZ-11504



JZ-11505



JZ-11506



JZ-11507



JZ-11508



LISITE JZ-11510



DAILY JZ-11511



JZ-11513



G-B JZ-11512



# JINZEN®

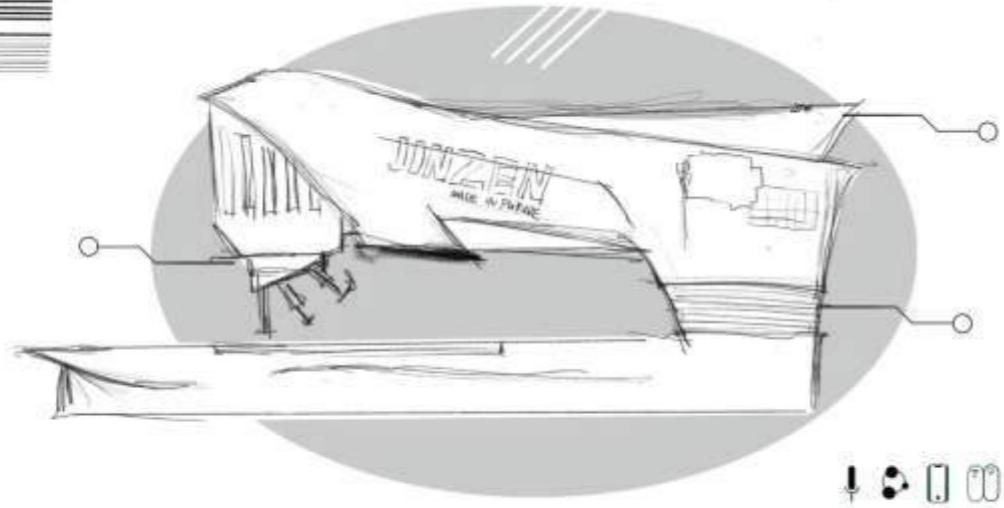

有一种传播叫口碑，口碑相传、永续经营中。  
产品的口碑是金振企业得以发展壮大的基石。

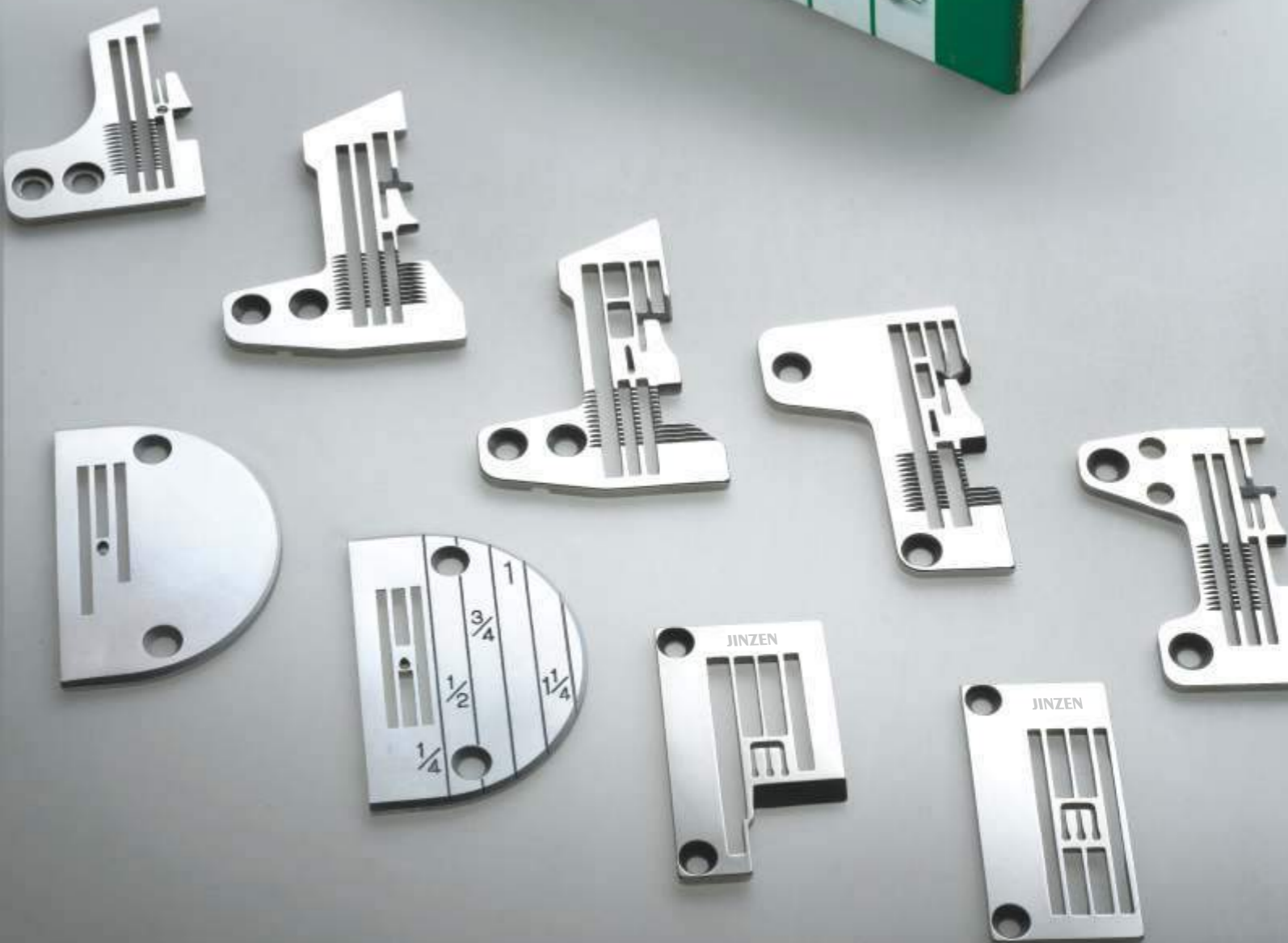







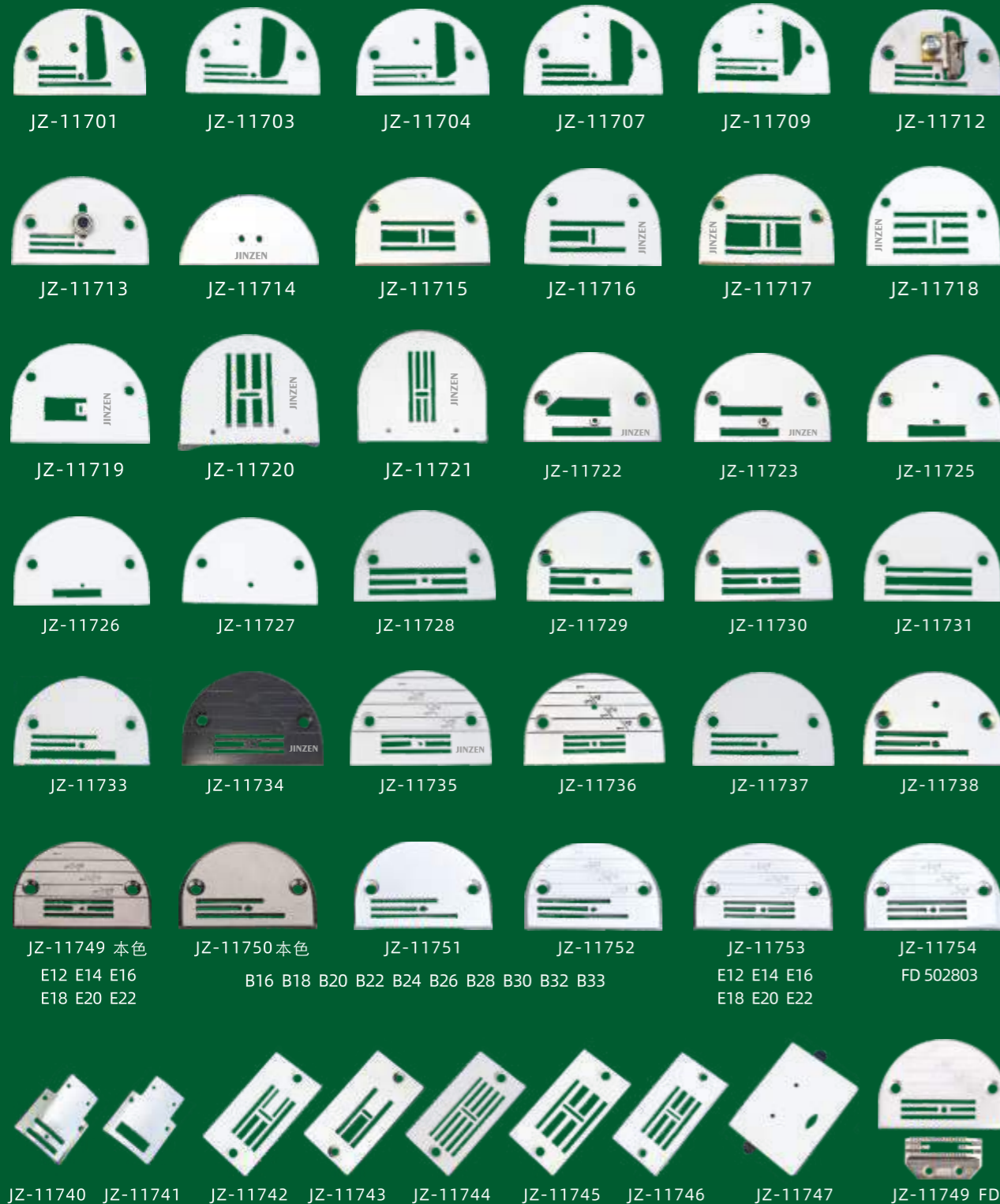















# JINZEN®

## NEEDLE PLATE 针板





 210783 210784 E52-211	 210796 210797 E52-130	 210799 210800 E52-130	 210804 210805 E52-132	 210809 210810 E52-131	 210837 210838 210839 E32-420	 210980 210981 210982 E32-542	 R4100HOACOO MO-2504	 R4200HODDOO R4305HOFDOO R4200HOFDOO MO-2504	 R4300HODEOO R4300HOFEOO MO-2504	 R4305HODEOO R4305HOFEOO MO-2514	 R4205HODEOO R4205HODEAO MO-2514	 R4206-HODEOO MO-2514	 R4308HODEOO R4308HOFEOO MO-2514
 210868 E32-451	 210986 210987 E32-542	 208674 208648	 208675 208676	 277500P40 277500P30 277500P50 Ex5204	 277512P15 277502P15 Ex5204	 277524T50 277524T60 EX3216H	 R4508HODDOO R4508HOEDOO R4508HOFDOO MO-2516	 R4608HODFOO MO-2516	 R4608HOFGOO MO-2516	 R4612HOFGOO R4612HOFBOO MO-2516	 R4608HODEOI	 R4612HODEOI MO-2516	 R4200JODDOO R4200JOEDOO R4200JOEDAO MO-3904
 277513R50 277513R40 Ex3216	 277516R60 277516R50 Ex3216	 277517R40 277517R50 Ex3216	 277505R40 277505R30 277505R50 Ex5214	 277519R40 Ex3244	 257015B32 257015B40 257015B48 257017B56 W561-01	 257016B48 W561-01	 R4300JOEEOO R4300JOFEOO MO-3904	 R4305JODEOO R4305JOFEOO MO-3914	 R4508JODDOO R4508JOEDOO R4508JOFDOO	 R4612JOEDOO R4612JOFDOO R4612JOFBOO MO-3916	 R4608JODDOO R4608JOEDOO R4608JOFDOO MO-3916	 R4608JOFDOO	 R4361FOGHOE R4361FOHFOE MF-890
 257018B56 257018B64 W561-01	 257018B56-N 257090C56 W561-01	 257018C56 W542-03	 257018D56 W561-03	 257090B56 W561-03	 257097B56 257097B64 N644-03	 257108B56 257108B64 W664-08	 B1137-352-000 MO-352	 B1136-357-A00 B1136-357-B00 B1136-357-C00 MO-357	 R4612LOFGOO MO-3316	 R4612LOHGOO MO-3316	 R4361FOGFOB R4361FOHFOB MF-870	 50324B5.6 MF-7407	 MS-1261 1/4
 206276 206277 W61-01	 257033B56 257033B64 W561-02	 257030B48 257032B56 257032B64 W561-02	 257050B40 W561-05	 257050B48 W561-05	 257053B56 257053B64 W561-05	 257102B56 257102B64 W664-35	 B2402-761-000 LBH-761	 B1190-522-SOO DLM-5200 1/8 B1190-522-TOO DLM-5200 3/16	 12422	 B1192-522-000 DLM-5200	 B2402-771-000 LBH-780	 B1103-380-DOO B1103-380-FOO1/4 MH-380	 MS-26 1/4
	 R4200EODCOO R4200EODDOA MO-804	 R4205EODEOO MO-814	 R4305EOEEOO R4305EODEOO R4305EODEOA MO-814	 R4508EODCOO MO-816	 R4608EOFGOO MO-816	 R4612EOFGOA MO-816	 14-8540 14-8640 W8003D	 14-8180 14-8190 W8003D	 14-763 14-764 DWK1802D	 14-889	 14-890 14-891	 14-845 14-847 W8103	 14-860 14-861 14-862 W8803C
 R4300EOFEEO MO-804	 R4308EODEOO MO-814	 R4200LOEEEO MO-3316	 R4300LOFEEO MO-3304	 R4305LOEEEO MO-3314	 R4508LOEGOO MO-3316	 R4608LOEGOO MO-3316	 14-896 14-897	 14-801 14-802 W8003C	 14-854C DWK1803D	 14-854D DWK1803D	 14-744B DVK-1702D	 14-855 14-865	 14-745B 14-753

## KANSAI



														
14-858 14-868 DWK1803EMK	14-746 14-756 14-766 DWK1802F	14-856 14-866 DWK1803F	14-728 14-738 14-748 14-756 14-768 Y7102EMK	14-812 14-813	14-811 14-814	14-301 14-302 DPW-1302S	<b>Yamato</b>	34564 34565 34566 DCZ-503	2048000	32666 32667 DCE-200	34893 34894 DCE-200	32671 32673 32672 DCE-203	33353 32678 dce-220W	
														
14-790 14-791	14-784 14-785	14-612	14-760 14-760H B2000C	14-5530 1503PHD	14-5800 1508P 1/4X7/8X1/4	14-5810 1508P 1/4X1X1/4	35334 DCE-341	34598 34585 DCE-520	33541 36570 DCE-361	33545 36590 DCE-361C	Y21768 21769 Z5003	Y21774 Z5003	Y21781 Z5020	
														
<b>SIRUBA</b>							21787 Z5020	Y21812 Y21813 Z6000	Y2022 E6000	2108000 2108001 HZ8000H	2108002 AZ8003H	2108003 AZ8003H	2108006 2105014 AZ8020H	
														
E4326 E4326P E4327 E4327P COO7D	E6326 E6327 FOO7E	E2635D COO7D	E2625P E2626P E2627P COO7E	E4826 F007	E4836M E4837M FOO7E	E3626P COO7E	2108006 2108014 AZ8020H	2108013	2108008B	2108064 Az8000	2108062	2108050 2108051	2108052 2108053 2108076	
														
E589 E590 737	E589F 737	E591 E591A 747	E591B 747	E591E 747	E591F 747	E783 E784 737	90166 90167 DW-100 DW-1350 94800 94801 94802	93170 93171 93172 VF-2400	3108133 3108134 3108135 VC-2700	95260 95261 95262 DV-1409	95278 95279 DW-1509	3208096 3208097 VF-2539	3208093 3208094 VF-2539	
														
E796 E797 737	E804 E805 747	E809 E919 E810 E920 747	E800 737	E934 737	E868 E870 757	E868D E871 757	94801C	94801D Y3108134D DN-2500 VC-2700	94801-N VF-2500 VC-2700	94801B VF-2500	Y3508003	Y3508021	3508019	
														
E982 757	E986 757	E988 767	E989 767	E834 757	E853 757	E851 757	Y3118023 256 Y3118024 264 Y3118025 356 VC-3711	3508100	3008025 VF-2503	95234 VF-1403	95085 VF-2503	94210 94211 94212 VF-2403	94281 90556 90557 VF-2403 DW-303	91764 91765 94901 94901 94902 DW-103 DW-1353





**JINZEN**<sup>®</sup>

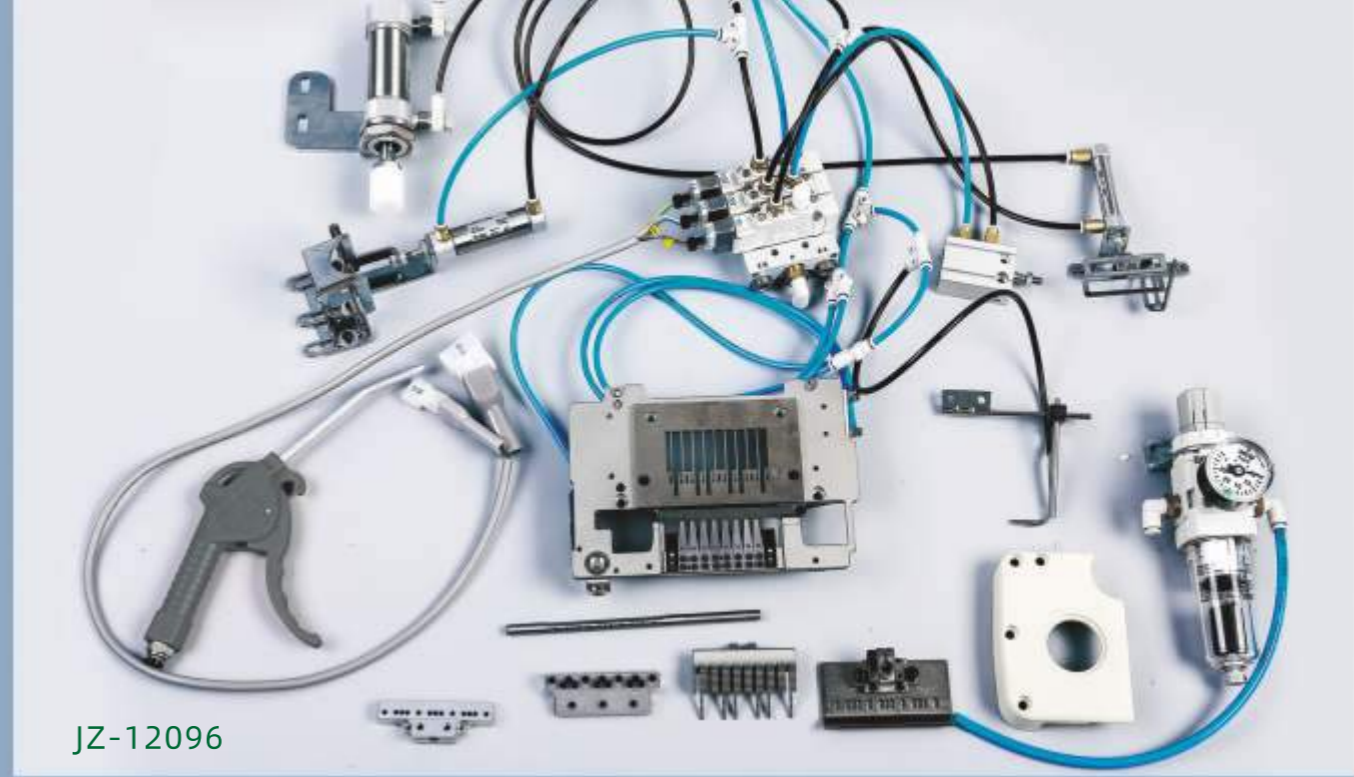

JZ-12096



JZ-12097

JZ-12098 1509 1-5/8



JZ-12099

JZ-12100 J1412 1/8X17H 牙带孔



# JINZEN® GAUGE SET



1404P 4N 1/4 3/16 5/16 3/8  
1412P 4N 1/2 7/16 1/4 1/2  
JZ-12101



1404/1412P 6N 1/4 3/16 5/16 3/8  
JZ-12102



1404P 8N 1/4 3/16 5/16 3/8  
1412P 8N 1/2 7/16 1/4 1/2  
JZ-12103

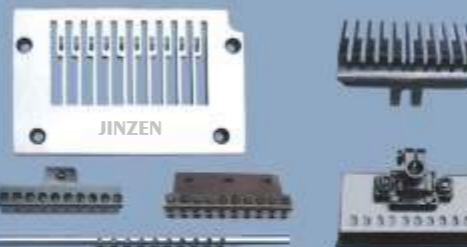

1404/1412P 10N 1/4 3/16  
JZ-12104



1404P 11N 3/16 1/8 1/4 3/16 5/16 3/8  
1412P 11N 1/2 7/16 1/4 1/2 3/4  
JZ-12105



1404P 12N 3/16 1/8  
1412P 12N 3/16 1/8 1/4  
JZ-12106

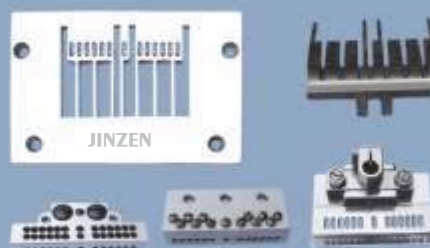

1412P 13N 1/8 3/16 1/4 3/8  
JZ-12107



1404P 15N 1/8 3/16 1/4 3/8  
1412P 15N 1/8 3/16 1/4 3/8  
JZ-12108

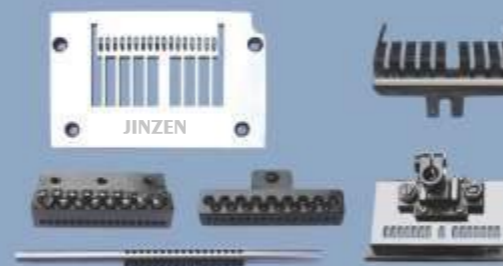

1404P 17N 1/8  
JZ-12109

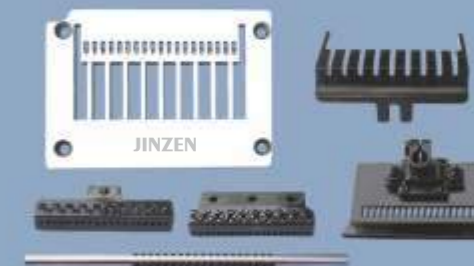

1412P 19N 1/8  
JZ-12110

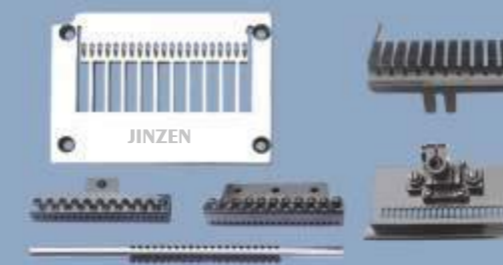

1412P 21N 1/8  
JZ-12111

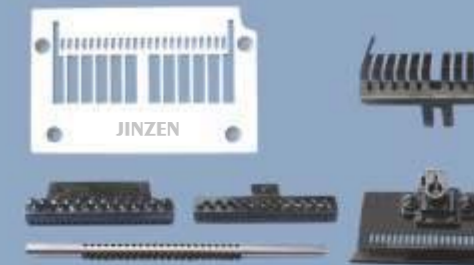

1412P 23N 1/8  
JZ-12112

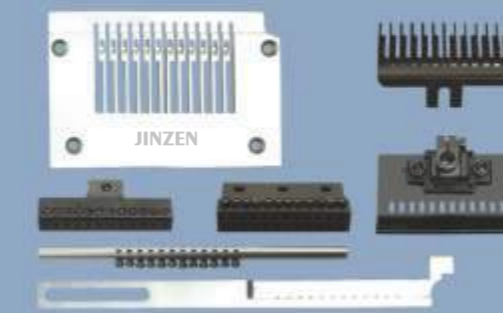

12N  
JZ-12113

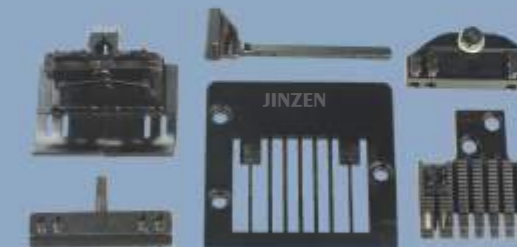

JUK I 1410  
JZ-12114

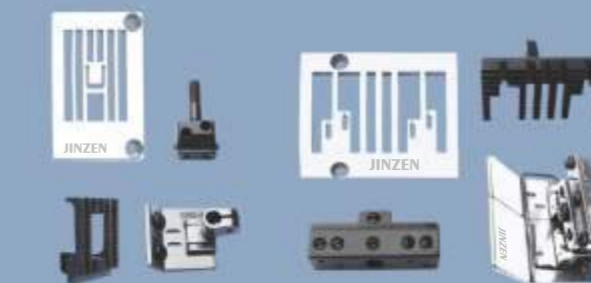

1702 JZ-12117 1508P JZ-12115



33N  
JZ-12116



JZ-12120  
KANSAI  
7N 12N 16N 25N 33N

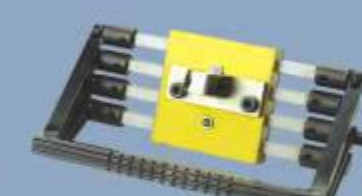

JZ-12118  
SIRUBA  
7N 12N 16N 打搅架

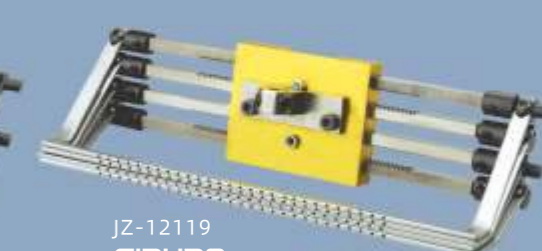

JZ-12119  
SIRUBA  
25N 33N 打搅架





**JINZEN®**  
**GAUGE SET**  
 HIGH QUALITY



JZ-12194 1/8 5/32 3/16 7/32 1/4 5/16  
 842-TR 3/8 5/8 1/2 3/4 7/8 1"



JZ-12195 1/8 5/32 3/16 7/32 1/4 5/16  
 3568-7 3/8 5/8 1/2 3/4 7/8 1"



JZ-12196 双针开门襟针位 1/4 3/16



JZ-12197 双针制帽针位 1.8MM 2.0MM



JZ-12224 假发针位组 4.0MM 4.8MM



JZ-12198 假发针位组

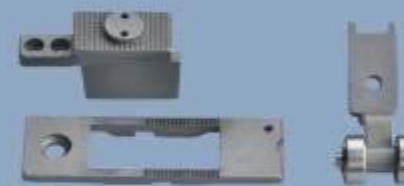

JZ-12199 双针模板机针位

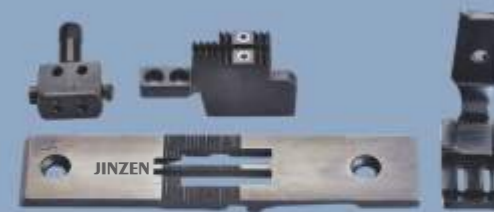

JZ-12200 日星针位



LH515 (831) 1/8 5/32 3/16 7/32 1/4 5/16  
 3/8 5/8 1/2 3/4 7/8 1"

JZ-12201



LH1162 1/8 5/32 3/16 7/32 1/4 5/16  
 3/8 5/8 1/2 3/4 7/8 1"

JZ-12202



LT2-B845 1/8 5/32 3/16 7/32 1/4 5/16  
 3/8 5/8 1/2 3/4 7/8 1" 1/4

JZ-12203



B845-TR 1/8 5/32 3/16 7/32 1/4 5/16  
 3/8 5/8 1/2 3/4 7/8 1"

JZ-12204



LH3168 1/8 5/32 3/16 7/32 1/4 5/16  
 3/8 5/8 1/2 3/4 7/8 1"

JZ-12205



LH3168-7 1/8 5/32 3/16 7/32 1/4 5/16  
 3/8 5/8 1/2 3/4 7/8 1"

JZ-12206



GC20202 1/8 5/32 3/16 7/32 1/4 5/16  
 3/8 5/8 1/2 3/4 7/8 1"

JZ-12207



21010 1/8 5/32 3/16 7/32 1/4 5/16  
 3/8 5/8 1/2 3/4 7/8 1"

JZ-12208



双针切割针位组 1/8 5/32 3/16 7/32 1/4 5/16  
 3/8 5/8 1/2 3/4 7/8 1"





















JZ-12209



DU 针位 1/8 5/32 3/16 7/32 1/4 5/16  
 3/8 5/8 1/2 3/4 7/8 1"

JZ-12210



JZ-12214 DT6-B927 6.4mm(1/4)	JZ-12227 DT6-B928 6.4mm(1/4)	JZ-12228 DT6-B928-7 3.2mm x2(1/8 x 2)	JZ-12229 DT6-B928-6 3.2mm x2(1/8 x 2)	JZ-12230 DT6-B927-8 4.8mm(3/16)
中厚料 Medium materials	特厚料 Extra heavy materials	厚料 Heavy material	特厚料 Extra heavy materials	薄料、中厚料 Thin materials Medium materials
1-1  S11508-101	1-2  150666-001	1-3  148864-001	1-4  150667-001	1-5  S05946-101
2-1  S40370-001	2-2  150673-001	2-3  148867-101	2-4  150675-101	2-5  S40369-001
3-1  106160-101	3-2  150668-101	3-3  148865-201	3-4  150672-101	3-5  S40355-001
4-1  183978-001	4-2  181716-001	4-3  183954-001		
5-1  148973-001	5-2  148875-001	5-3  S06310-001		
6-1  148876-001-0				

1:111443003  
2:062671012  
3:021670102  
4:148876-001-0





# JINZEN® GAUGE SET



JZ-12312 L32



JZ-12313 DCZ-220



JZ-12301 M03314



JZ-12302 M02516



JZ-12314 W562-5



JZ-12315 1302



JZ-12303 SH7000



JZ-12304 AZ8020



JZ-12316 747



JZ-12317 M03614



JZ-12305 531



JZ-12306 EX3200



JZ-12318 W600



JZ-12319 JUKI 2516 SIX STREAD



JZ-12307 EF-C21



JZ-12308 W500



JZ-12320 PEGASUS SIX THREAD



JZ-12322



JZ-12309 SIRUBA SIX STREAD



JZ-12310 JUKI 3616 SIX STREAD



JZ-12321 飞马包兜机针位



# GAUGE SET



JZ-12323 W500 模具针位



JZ-12324 200020B3560 GAUGE SET



JZ-12325 VT1500 导骨宽槽 4.8 针位



JZ-12326 VT1500 导骨窄槽 5.6 针位



JZ-12327 VT1500 立骨窄槽 5.6 针位



JZ-12328 VT1500 导骨 6.4 针位



JZ-12329 VT1500 导骨窄槽 4.8 针位



JZ-12330

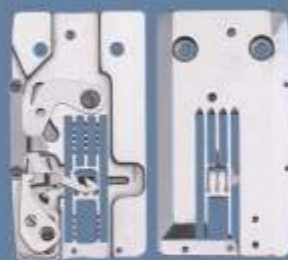

JZ-12331

# JINZEN® TEFLON 铁氟龙系列



JZ-12401



JZ-12402



JZ-12403



JZ-12404



JZ-12405



JZ-12406



JZ-12413 FD



JZ-12408



JZ-12409



JZ-12410



JZ-12411



JZ-12412



JZ-12400



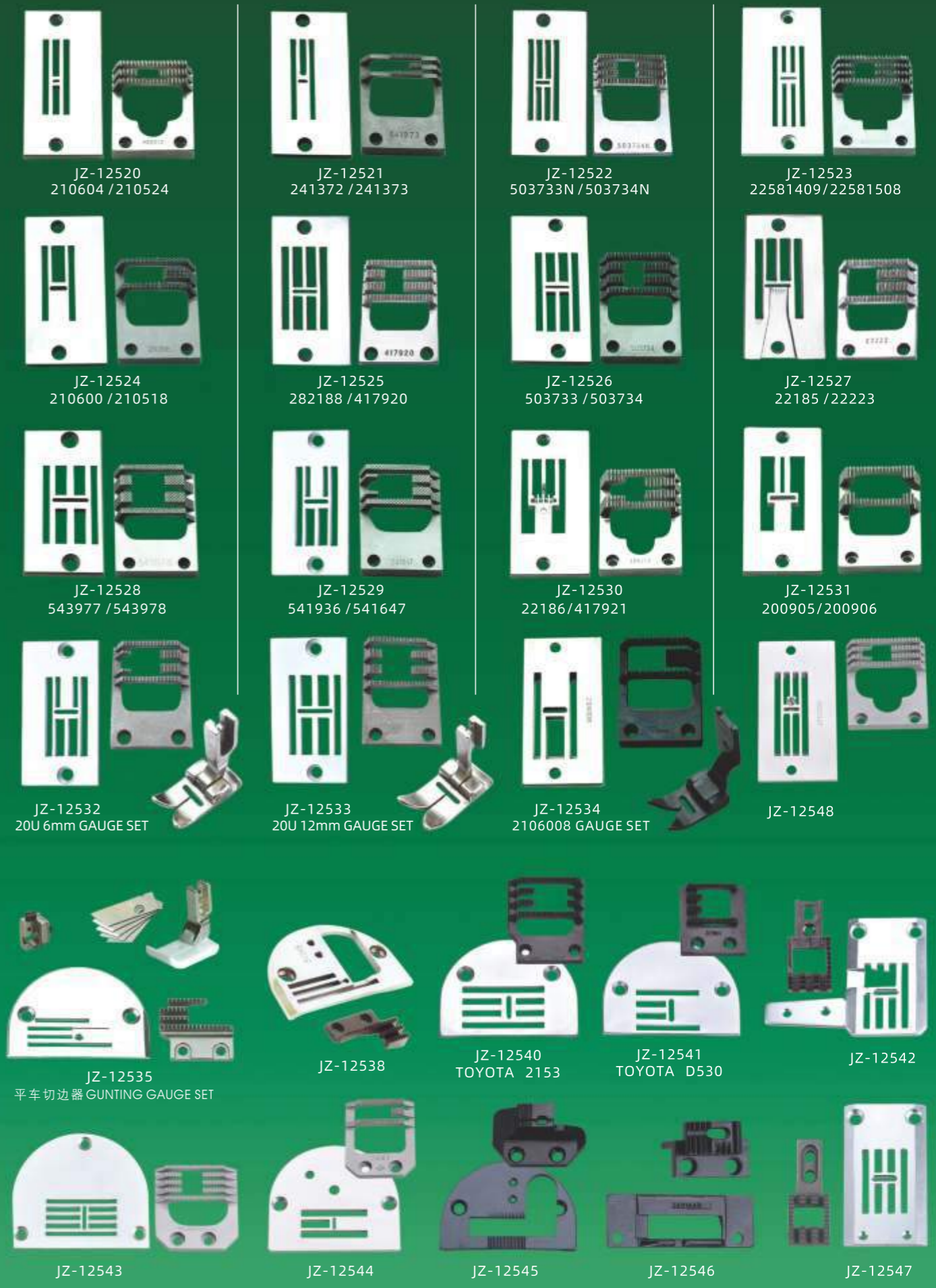



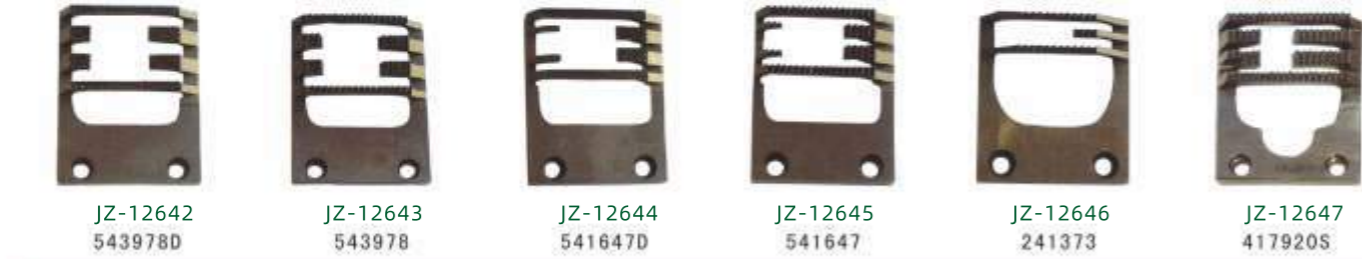
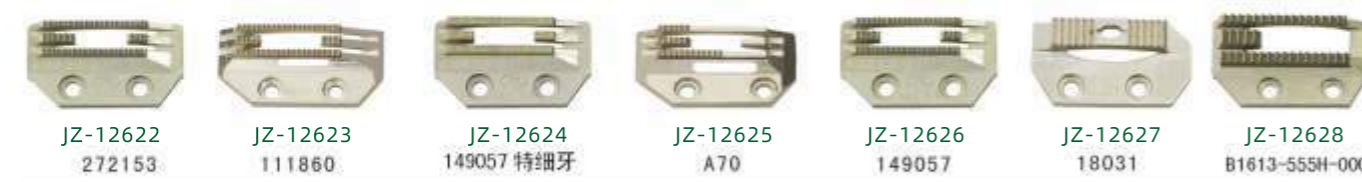



 HI258/DI206	 HI259/DI207	 257262/257216	 HI261/DI215	 257258/257206	 3209002/3209003	 DL4	 15-704	 FE15	 FD-62G 双切牙子	 FD-62G 单切牙子	 15-760
 HI262/DI216	 257259/257207	 DF00560/FDF00560	 3209001/3209000	 257290/257243	 15-8060/15-8050	 3159034/3159037	 34726F/34705F	 H1359/D1207	 3209012/3209013	 祖奇241牙	 B1657-816-000 B1656-816/B1658-804
 257242/257289	 Y3109020 Y3109021	 257243/257290	 3109000/3109001	 DFC00560/FDC00560	 H4258/D4206	 3509036/3509037	 Y3509036/Y3509037	 FE40/FE16-2/FE41	 Y93394/Y93395	 3209008/3209009	 257268-16F/257222-16F
 208217/208064	 208215/208063	 208219/208066	 146572/146567	 210445/210575	 204675A 204676	 3109002/3109003	 3509004/3509005	 15-753/15-723	 15-756/15-727	 关西四行牙	 90624/90625
 204676/208078-BF	 204676/208079-BF	 146748/146744	 H445/D574	 204732 204675 204674	 H974/D969	 Y34852/34851	 21842/21846	 6509012 6509002/6509022	 H3362/D3216	 15-36/15-301	 50326AY/50305BA
 210442/210569	 210494/210581	 210501/210582	 H501/D582	 H497/D581	 H500/D581	 146750/146745	 四线打皱牙	 202854A/201094B	 201097C/201094B	 131657-814-BOL 118-83402/87106	 131657-814-BOA 131656-814-BOA 131658-804
 H445/D575	 H494/D581	 H442/D290	 210497/210581	 204730/208090-BF	 BI657-804-00T/82107	 277327-16F 277329-16F	 Y2109050/Y2109051	 277323/277325	 H497/D498	 Y2108050/Y2108051	 Y2109000/Y2109001
 DF-8040T/82107	 BI657-814-B0E/97101	 DF-86504/FD824	 118-86504/82404	 DF-814BE/FD971	 118-86009/84004	 S20245/S20241	 S19240-001 S19212-001	 H959/D996	 H957/D002	 277304-16F 277305-16F	 277300-16F 277302-16F
 DF-85407/FD830	 I21735/83006	 118-85407/83006	 I21-73308/84004	 118-85209/82800	 I21-72805/82800	 208224/208063	 208215 / 208063	 208218/208065	 213118-16FO	 204420/208074	 118-85902 118-84103/87403



“精工细作，终成大器”

Exquisite and scrupulous working makes perfect.

JINZEN® 弯针王  
LOOPER KING



三十年的技术沉淀  
只为对客户的一个承诺

JUKI					
118-88005-80#	118-88104-81#	118-88203-82#	118-88302-83#	119-99208-92#	
121-76004-60#	121-76103-61#	124-81008-10#	124-81107-11#	B2519-804	B2519-814
B2521-814	B2521-804	119-99307	118-88401	119-99802	124-81800
B2009-038-D00 3/16B	B2009-038-K00 3/8B	B2008-038-D00 3/16A	B2008-038-K00 3/8A	MH481 B2030-481-000	MH380 B2031-380-000
MS1190 129-69101	MS1190 129-79209	MS1190 129-79308	MS1190 129-68509	MS1190 129-68806	MS1190 129-68868
MS1190 129-68905	MS1190 129-68508	1/4A B2513-026-F00 MS-26	1/4B B2514-026-000 MS-26	A1/8 B2513-019-B00 MS-19	1/8B B2514-019-B00 MS-19



# HIGH QUALITY LOOPER

JINZEN®



118-90704



35825



B1239-372



B1239-373



121-77903



124-84200



118-90605



118-90001



124-84002



124-84507



120-15301



118-90506



B2311-380



B2311-382



28-3



28-3



B2312-380



B2315-380



HG-001



HG-002



HG-003



HG-004



118-90100



JZ-22304



1/4B  
B2514-019-F00  
MS-19



1/4C  
B2515-026-F00  
MS-26



1/4A  
B2513-019-F00  
MS-19



121-20705



118-29405



124-82600

brother



S20430001



148869  
B926-6A



S08913



S20627-001



146726-001



158433



146962



S20438001



148870  
B926-6A



S40391-001 3/16B  
B927



S20626-001



144127



S38306



147934



S20424001



148871  
B926-6A



111156-001 1/4C



S20653-001



S20418



S20415



144042



146613-001



S40375-001  
B928



S40392 3/16A  
B927



144049-001



146635-001



147936



148875



S40376-001  
B928



111160-001 1/4B



S01249-001



B3901-880-A00



9820



147937



S03536-001



S40377-001  
B928



111162-001 1/4A



S01248-001



2200



9820



PEGASUS





**KANSAI**



19-416



19-581



19-582



19-811



19-512



19-112



19-431A 2.5mm



19-431S 2.3mm



19-431 3.2mm



19-431N 2.7mm



19-525



19-531



19-353



19-362



19-518



19-535



19-801



19-363



19-351



19-539



19-713



19-810



19-536



19-712



19-807



19-505



19-751



19-437

**Ijamato**



6209300



6209302



6209304



2109320



2109322



32807



36228



34584



33610



3109200



2109322



68123  
5.2#



68123  
6.0#



6509201



2119301  
Y1



2119302  
Y2



3109300



2109201



2109214



2109210



6209201



6509300



68217



3209311



63178



302056



90529



94480



6509200



Y68124



6209301



32416



2109300



2109347



31261



35253



35254



34393



34392



2119324



2109212



2109302



3109310



3209300



6109305



90425



93659



# HIGH QUALITY LOOPER

**Kingtex**



UL603883-83#



UL603882-82#



UL603880-80#



UL603881-81#



2213UL002



NG00561



NG00560



GUL604152



GUL605150



UL603886



NG603901



NG605906



5221NG0005



5212NG0004



NG604903



NG603900



5212NG0001



NG605905



LL603884



LL603885



LL2130001



5212LL0001



5212LL0002



5212NG0003



CL605294



SLF00560



SLC00560



LLC00560



51809



51808



54208B



51108DA



51909C

**UNION**  
于仁

**SINGER**



32822



32820



32823



32821



32824



139056 1/4C



139433 3/16A



139433 1/4A



139057 1/4B



139288 1/4A



139434 1/4B



139434 3/16B



550411



550568



548232



548231



548205

548207



对丝机零件



JZ-P065-3



JZ-P065-4



SIRUBA



OTHER





JINZEN®

# One-stop solution

缝配服务一站式采购



重机JUKI 3200 LOOPER



杜克普DURKOPP557 LOOPER



杜克普DURKOPP558 LOOPER



兄弟BROTHER980 LOOPER



利士REECE101 LOOPER



利士REECE104 LOOPER



9820



580



579



559



3200

## HIGH QUALITY LOOPER

取材优质，弯针孔和弯针槽没有毛刺，角度标准个个通过严格检测。  
 JINZEN looper use high-quality material, the hole and slot are grounded, and each angle standard has got through strict inspection.





**Kingtex  
宝狮**



**NC605048**  
JZ-12801



**NC604026**  
JZ-12802



**NC604022**  
JZ-12803



**NCC00561**  
JZ-12804



**NCC00641**  
JZ-12805

**SEN BEN  
森本**



**12-828**  
JZ-12806



**12-807**  
JZ-12807



**12-826**  
JZ-12808



**12-839**  
JZ-12809



**12-838**  
JZ-12810



**12-229**  
JZ-12811



**12-819**  
JZ-12812



**12-818**  
JZ-12813



**12-812**  
JZ-12814



**12-811**  
JZ-12815



**12-813**  
JZ-12816



**12-802**  
JZ-12817



**12-801**  
JZ-12818



**810 1/16**  
JZ-12819



**810 3/32**  
JZ-12820



**8810 2.4**  
JZ-12821



**380 1/8**  
JZ-12822



**925 1/4**  
JZ-12823



**MS19 1/4**  
JZ-12824



**8-1 1/4**  
JZ-12825



**515 1/4**  
JZ-12826



**1190 1/4**  
JZ-12827



**926-8A**  
JZ-12828



**MS26**  
JZ-12829



**926**  
JZ-12830



**1162 1/4**  
JZ-12831



**20202 1/8**  
JZ-12832



**845 1/8**  
JZ-12833



**3168 9/16**  
JZ-12834



**手跳3/16针头**  
JZ-12835



**手跳1/2针夹**  
JZ-12836



**35800**  
JZ-12837



**35800**  
JZ-12838



**35800**  
JZ-12839



**928**  
JZ-12840



**928**  
JZ-12841



**928**  
JZ-12842



**1190**  
JZ-12843



**1190**  
JZ-12844



**MS19**  
JZ-12845



**MS19**  
JZ-12846



**925**  
JZ-12847



**1261**  
JZ-12848

**Ijamato  
大和**



**2159112**



**Y3209100**



**Y3209102**



**Y93351**

**PEGASUS  
飞马**



**179630-92**



**257517-40**



**257517-32**



**2159102**



**2109100**



**Y3209102**



**3209107**



**Y93352**



**209670**



**277022-92**



**257517-48**



**257518-56**



**FC364**



**2109232**



**2109102**



**Y3209107**



**3109111**



**3109111**



**208905**



**277028-92**



**257518-64**



**257513-460**



**FC364**



**2109120**



**2109101**



**Y3209102**



**3109112**



**Y93353**



**208914**



**277027-92**



**257518-48**



**236631-56**



**FC348**



**2109122**



**2109112**



**3209101**



**Y93356**



**Y93357**



**208909**



**277031-92**



**257517-56**



**257517-64**



**FC240**



**2159111**



**2109110**



**Y3209108**



**Y93358**



**208910**



**208965**



**208965**



**257518-60**



**257518-60**



**35818BY9**

**SHING LING  
星菱**



## brother 兄弟



## JUKI 重机



## SIRUBA 银箭



# PRESSER FOOT

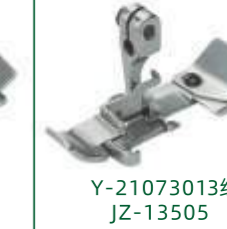



# PRESSER FOOT



PEGASUS4线  
JZ-13537



747 4线  
JZ-13538



JZ-13539



JZ-13540



JZ-13541



JZ-13542



JZ-13543



JZ-13544



JZ-13545



JZ-13624 D/N 1/4



JZ-13625 无纺布压脚



257321-64  
JZ-13547



JZ-13548



208649  
JZ-13549



208502  
JZ-13550



P502中厚料  
JZ-13551



3316 5线  
JZ-13552



208504  
JZ-13553



P504  
JZ-13554



P233  
JZ-13555



P509  
JZ-13556



M0816  
JZ-13557



P955  
JZ-13558



208955  
JZ-13559



P005银箭包兜  
JZ-13560



257471-56  
JZ-13561



257472-64  
JZ-13562



W500压脚  
JZ-13563



W500滚珠压脚  
JZ-13564



257472-56  
JZ-13565



P0217  
JZ-13566



17-836  
JZ-13567



S08826  
JZ-13568



W500 4针六线  
JZ-13569



P2446  
JZ-13570



257485  
JZ-13571



P5117  
JZ-13626



YAMATO  
JZ-13573



17-8850-1  
JZ-13574



208952 / 208108  
JZ-13575



119-32456 / 36804  
JZ-13576



123-30007 / 20057  
JZ-13577



YAMATO  
JZ-13578



17-301  
JZ-13579



2200R 5.6MM  
JZ-13585



Y3117124 VG3711  
JZ-13591



211909  
JZ-13597



257331A56  
JZ-13603



32760  
JZ-13609



S19260-001  
JZ-13580



Y95587 5.6MM  
JZ-13586



Y3507064 VG3721  
JZ-13592



S19313-201  
JZ-13598



148013-001  
JZ-13604



32750  
JZ-13610



201230C  
JZ-13581



257240 5.6MM  
JZ-13587



Y95316 5.6MM  
JZ-13593



124-70258  
JZ-13599



146871  
JZ-13605



33539  
JZ-13611



S19280-001  
JZ-13582



VG2700 5.6MM  
JZ-13588



17-760  
JZ-13594



2117035  
JZ-13600



2117024  
JZ-13612



五线窄压脚  
JZ-13606



2117024  
JZ-13612



146902-001  
JZ-13583



JH004-053A 5.6MM  
JZ-13589



17-361  
JZ-13595



五线打皱压脚  
JZ-13601



PF634D03  
JZ-13607



四针六线压脚  
JZ-13613



圆线打皱压脚  
JZ-13584



94909 5.6MM  
JZ-13590



17-889  
JZ-13596



212887A  
JZ-13602



圆线打皱压脚  
JZ-13608



B1510-352-0A0  
JZ-13614



B1510-357-AA0  
JZ-13615



B1507-816-0A0  
JZ-13616



B1507-814-0A0  
JZ-13617

FD356  
JZ-13618



P2408  
JZ-13619



P103-4  
JZ-13620



747肩带  
JZ-13621



205136  
JZ-13622



17-899  
JZ-13623

380 改装压脚  
JZ-13627



好品質，源于臺灣！  
Good quality, from Taiwan!



JZ-13680  
卷边压脚



JZ-13681  
P351



JZ-13682  
P127



JZ-13683  
高低压脚

JINZEN<sup>®</sup>  
PRESSER FOOT





WHOLE STEEL PRESSER FOOT 全钢压脚



JZ-13701

CL1/32N  
CL1/16N  
CL3/32N  
CL1/8N  
CL5/32N  
CL3/16N  
CL1/4N  
CL5/16N  
CL3/8N  
CL1/2N



JZ-13702

CR1/32N  
CR1/16N  
CR3/32N  
CR1/8N  
CR5/32N  
CR3/16N  
CR1/4N  
CR5/16N  
CR3/8N  
CR1/2N



JZ-13703

CL1/32E  
CL1/16E  
CL3/32E  
CL1/8E  
CL5/32E  
CL3/16E  
CL1/4E  
CL5/16E  
CL3/8E  
CL1/2E



JZ-13704

CR1/32E  
CR1/16E  
CR3/32E  
CR1/8E  
CR5/32E  
CR3/16E  
CR1/4E  
CR5/16E  
CR3/8E  
CR1/2E



JZ-13705

CLK  
CL1/32K  
CL1/16K  
CL3/32K  
CL1/8K  
CL5/32K  
CL3/16K  
CL1/4K  
CL5/16K  
CL3/8K  
CL1/2K



JZ-13706

CRK  
CR1/32K  
CR1/16K  
CR3/32K  
CR1/8K  
CR5/32K  
CR3/16K  
CR1/4K  
CR5/16K  
CR3/8K  
CR1/2K



JZ-13707

12463HR  
1/32 (P810)  
1/16 (P811)  
3/32 (P8115)  
1/8 (P812)  
3/16 (P813)  
1/4 (P814)  
5/16 (P815)  
3/8 (P816)  
1/2 (P818)



JZ-13708

12463HL  
1/32 (P810L)  
1/16 (P811L)  
3/32 (P8115L)  
1/8 (P812L)  
3/16 (P813L)  
1/4 (P814L)  
5/16 (P815L)  
3/8 (P816L)  
1/2 (P818L)



JZ-13709

36069HL  
P69LH-1/16  
P69LH-1/8  
P69LH-3/16  
P69LH-1/4  
P69LH-5/16



JZ-13710

36069HR  
P69RH-1/16  
P69RH-1/8  
P69RH-3/16  
P69RH-1/4  
P69RH-5/16



JZ-13711

SP-18L  
SP-18L 1/16  
SP-18L 1/8  
SP-18L 3/16  
SP-18L 1/4



JZ-13712

SP-18R  
SP-18R 1/16  
SP-18R 1/8  
SP-18R 3/16  
SP-18R 1/4



JZ-13713

LOT NO.  
160344 1/16 (NO.1)  
120938 3/32 (NO.2)  
120803 1/8 (NO.2-1/2)  
120804 5/32 (NO.3)  
120805 3/16 (NO.4)  
120940 7/32 (NO.5)  
120806 1/4 (NO.6)  
120803 5/16 (NO.7-1/2)



JZ-13714

A10 PRESSER FOOT  
A10-5/8  
A10-3/4  
A10-7/8  
A10-1  
A10-1-1/8  
A10-1-1/4  
A10-1-1/2  
A10-1-3/4



JZ-13715

36465  
P10-1/32  
P11-1/16  
P115-3/32  
P12-1/8  
P13-3/16  
P14-1/4  
P15-5/16  
P16-3/8  
P18-1/2



JZ-13716

CD  
CDN-1/32(D23N)  
CD-1/32(D23)  
CDN-1/16(D231N)  
CD-1/16(D231)  
CD-1/8(D232)  
CD-3/16(D233)  
CD-1/4(D234)



JZ-13717

211-15  
211-13(1/16x3/16)  
211-14(1/16x1/4)  
211-15(1/16x5/16)  
211-16(1/16x3/8)  
211-18(1/16x1/2)



JZ-13718

S10R  
P318R-1/8  
P3316R-3/16  
P314R-1/4  
P3516R-5/16  
P338R-3/8  
P3716R-7/16  
P312R-1/2  
P358R-5/8  
P334R-3/4  
P378R-7/8  
P325R-1



JZ-13719

S570R(P112H)  
1/8x1/32  
3/16x1/32  
1/4x1/32  
5/16x1/32  
3/8x1/32  
1/2x1/32  
5/8x1/32  
3/4x1/32  
7/8x1/32  
1" x1/32



JZ-13720

S570L (P112L)  
1/8x1/32  
3/16x1/32  
1/4x1/32  
5/16x1/32  
3/8x1/32  
1/2x1/32  
5/8x1/32  
3/4x1/32  
7/8x1/32  
1" x1/32



JZ-13721

S570DG (P112HD)  
1/8x1/32  
1/4x1/32  
5/16x1/32  
3/8x1/32  
7/16x1/32  
1/2x1/32  
9/16x1/32  
5/8x1/32  
11/16x1/32  
3/4x1/32  
7/8x1/32  
1" x1/32



JZ-13722

S570 (P112HL)  
1/8x1/16  
3/16x1/16  
1/4x1/16  
5/16x1/16  
3/8x1/16  
1/2x1/16  
5/8x1/16  
3/4x1/16  
7/8x1/16  
1" x1/16



JZ-13723

S570L (P112HL)  
1/8x1/16  
3/16x1/16  
1/4x1/16  
5/16x1/16  
3/8x1/16  
1/2x1/16  
5/8x1/16  
3/4x1/16  
7/8x1/16  
1" x1/16



JZ-13724

S570DG (P112HD)  
3/16x1/16  
1/4x1/16  
5/16x1/16  
3/8x1/16  
7/16x1/16  
1/2x1/16  
9/16x1/16  
5/8x1/16  
11/16x1/16  
3/4x1/16  
7/8x1/16  
1" x1/16



JZ-13725  
P36LN



JZ-13726  
P36N



JZ-13727  
P363



JZ-13728  
12435N



JZ-13729  
31358N



JZ-13730  
12435W



JZ-13731  
121946



JZ-13732  
P351



JZ-13733  
24983



JZ-13734  
P360



JZ-13735  
P363NF



JZ-13736  
P127



JZ-13737  
B1524-012-0B0



JZ-13738  
B1524-522-B0A



JZ-13739  
B1524-522-NAA



JZ-13740  
CR1/16NS



JZ-13741  
P952



JZ-13742  
150789



JZ-13743  
S518S



JZ-13744  
S518NS



JZ-13745  
P31C 3/16



JZ-13746  
A-10 3/4



JZ-13747  
A-10 1-1/4



JZ-13748  
NL-315



JZ-13749  
36069L



JZ-13750  
36069DG



JZ-13751  
36069R



JZ-13752  
P50N



JZ-13753  
P5



JZ-13754  
36069L 3/8



JZ-13755  
P3819



JZ-13756  
S540



JZ-13757  
S538



JZ-13758  
CF351



JZ-13759  
RF1/32N



JZ-13760  
LF1/4



# PRESSER FOOT



JZ-14246 JZ-14247 JZ-14245 JZ-14255 JZ-14256 JZ-14257 JZ-14258 JZ-14259 JZ-14260



JZ-13761 P361-NF JZ-13762 P360-NF JZ-13763 R36N JZ-13764 R36LN JZ-13765 Cf361 JZ-13766 CF360



JZ-13767 P36N-NF JZ-13768 P733 1/8 3/16 5/16 7/8 3/8 1/4 JZ-13769 P738 1/32 JZ-13770 HR1/32N JZ-13771 P705 1/32 JZ-13772 P127-NF



JZ-13773 P721 1/8 JZ-13774 EP69RHN1/4 JZ-13775 UPP-1反 JZ-13776 UPP顺 JZ-13777 P351-NF JZ-13778 S543



JZ-13779 P351黑 JZ-13780 P351SH JZ-13781 S955 JZ-13782 P746 3/16 1/8 JZ-13783 CR3/16-NF JZ-13784 P701 1/4 5/32



JZ-13785 KP367PL JZ-13786 KP367W JZ-13787 KH367PF JZ-13788 269RN JZ-13789 K269LN



JZ-13790 尼龙皮革 JZ-13791 黄胶 硬皮革、真丝 JZ-13792 漆花 窗帘、沙发、绒布 JZ-13793 铁压脚 厚料通用 JZ-13794 带刀压脚 JZ-13795 P723带轮子



JZ-13796 P740 1/32 1/2 1/16 1/2 JZ-13797 P748 JZ-13798 CR1/8K CR1/4K JZ-13799 P748 1/16 JZ-13800 214-NF JZ-13801 P722 1/4



JZ-13802 1401600300 JZ-13803 1381601500 JZ-13804 1411600200 JZ-13805 1411600100 JZ-13806 11411600100 JZ-13807 B1601-210-000



JZ-13808 JZ-13809 JZ-13810 JZ-13811 模板机压脚方板 JZ-13812 JZ-13813 花样机辅助压脚



# WHOLE STEEL PRESSER FOOT 全钢压脚

											
411215 胜家人字靴-TH	10055051 祖奇人字压脚	22848671	MAB109000B0 祖奇胸罩靴	SA1231-9A 压脚	457G 13MM 胜家人字靴	21010-1L 6.4MM1/4S	21010-1R 6.4MM1/4S	21010-1L 6.4MM1/4W	21010-1R 6.4MM1/4W	212-112 1/4中带刀靴	457G-friend 梯型人字靴
											
107L 管正靴-大	23771正靴弹丝	107C 管正靴销钉-小	107C 管正靴弹-小	胜家人字靴-TH 503818	23207人字车压脚	双针打带压脚1/4	双针打带压脚 (全开槽) 1/4	23073 6.4MM 双针打带靴 (新款)	SZZM3/8 双针制帽压脚3/8	双针打拆压脚 1/4D/N	107C-4L (4L) 胜家人字靴
											
457G-KC-TS-02 人字靴开叉-弹丝-中	457G-PK-01 人字靴-平口-大	457G-PK-01 人字靴-平口-中	457G-PK-TS-01 人字靴-平口-弹丝大	457G-PK-TS-02 平口弹丝-中	457G-WC-01 人字靴-无槽-大	210569A 胜家人字靴	210569A	平车滚轮靴 F型	平车滚轮靴 (新型)	R2E滚轮压脚	1005505 JUKI 人字车压脚
											
457G-WC-02 人字靴-无槽-中	457G-WC-TS-01 人字靴-无槽-弹丝-大	457G-WC-TS-02 人字靴-无槽-弹丝-中	457 1/4 X1/32L 带刀靴	457 1/4 X1/32R 带刀靴	210569胜家人字靴	22548671 JUKI 人字车压脚	22548655 JUKI 人字车压脚	503736 人字靴 (新型)	457GB (23766A) 胸罩靴	210562A4	S950 (P950) 缩皱压脚
											
457G-KC-01 人字靴-开叉-大	457G-KC-02 人字靴-开叉-中	457 3*16X1/32R 带刀靴	457G-KC-TS-01 人字靴-开叉-弹丝-大	005-1-4A 胸罩车靴	212-005A 可调节捆条压脚	R2滚轮压脚	双针大孔压脚	P803	S537 1/4	棉花压脚	P723
											
005-1/8A胸罩车靴	457-AL 胸罩车平底靴-大	457-A 胸罩车平底靴-小	457-A 胸罩车平底靴-z弹-小	457-AL胸罩车 平底靴-弹丝-大毫	R23771滚轮压脚	652 8MM压脚	652 12MM压脚	P127L	5538105三菱双针压脚	DY340带刀压脚小号	L52-A型打折靴



# PRESSER FOOT







T350 T350B  
JZ-14301



T363 T363B  
JZ-14302



T36LN T36LNB  
JZ-14303



T36N T36NB  
JZ-14304



T65212mm T652B12mm  
JZ-14305



T652 9mm T652B 9mm  
JZ-14306



T652 6mm T652B 6mm  
JZ-14307



T36L T36LB  
JZ-14308



T351 T351B  
JZ-14309



T351 T351B 11mm  
JZ-14310



T35WB  
T35W 12.5mm  
JZ-14311



Mt1 MT2  
JZ-14312



MT-260B

MT-260 3/16,1/4,2/16,  
3/8,1/2,3/4,1#  
JZ-14313



MT-260 1/8 MT-1/8 B  
JZ-14314



MT-A MT-AB 12.5mm  
JZ-14315



528T-5.6 528TB  
JZ-14316



T35CWB

T35CW 11MM,12.5MM,15MM  
JZ-14317



T69R 1/8,1/4,3/16 T69RB  
JZ-14318



T69L 1/8,1/4,3/16 T69LB  
JZ-14319



T-S518 T-S518B  
JZ-14320



MT-18 YELLOW  
JZ-14321



T350L T350LB  
JZ-14322



T-107 T-107B  
12mm, 9mm, 6mm  
JZ-14323



T-S518 YKK  
JZ-14324



SPK6  
JZ-14325



飞马五线薄料  
JZ-14326



飞马五线厚料  
JZ-14327



飞马四线  
JZ-14328



银箭四线  
JZ-14329



MF23-7 MF23-7B  
JZ-14330



MF23-8 MF23-8B  
JZ-14331



T350D T350DB  
JZ-14332



T813 T813B  
JZ-14334



T812 T812B  
JZ-14335



T811 T811B  
JZ-14336



T815 T815B  
JZ-14337



TCL1/32,1/16,1/8,1/4,1/2  
JZ-14338



TCL1/32E,1/16E,1/8E,1/4E  
JZ-14339



TCR1/32, 1/16,1/8,1/4,1/2  
JZ-14340



TCR1/32E,1/16E,1/8E,1/4E  
JZ-14341



T814 T814B  
JZ-14342



SR-DB-R SR-DB-RB  
JZ-14343



TRF1-R  
JZ-14344



TRF1-R (绿)  
JZ-14358



0.5mm 0.8mm 1.0mm 1.2mm 1.5mm 2.0mm  
JZ-14359



JZ-14345



T8115SR T8115SRB  
JZ-14346



T812SR T812SRB  
JZ-14347



TRF1 TRF1B  
JZ-14348



T811SR T811SRB  
JZ-14349



JZ-14350



JZ-14351



JZ-14352



JZ-14353



JZ-14354



JZ-14355



JZ-14360

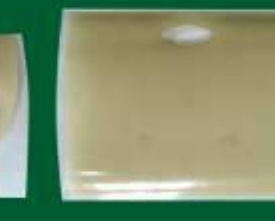

JZ-14356



JZ-14357









JZ-15223 Rubbe胶底  
B1511-761-0A0  
B1511-762-0A0  
B1511-763-0A0



JZ-15224 Rubbe凸胶底  
B1511-761-0A0  
B1511-762-0A0  
B1511-763-0A0



JZ-15225 Rsteel铁齿  
B1511-761-0A0  
B1511-762-0A0  
B1511-763-0A0



JZ-15226 Rubbe胶底  
B1511-771-0A0  
B1511-772-0A0  
B1511-773-0A0



JZ-15227 Rsteel凸铁齿  
B1511-771-0A0  
B1511-772-0A0  
B1511-773-0A0



JZ-15228 Rsteel铁齿  
B1511-771-0A0  
B1511-772-0A0  
B1511-773-0A0



JZ-15229 Rubbe胶底  
150763-001 16mm  
150764-001 25mm  
150766-001 32mm



JZ-15230 Rubbe凸胶底  
150763-001 16mm  
150764-001 25mm  
150766-001 32mm



JZ-15231 Rsteel铁齿  
150763-001 16mm  
150764-001 25mm  
150766-001 32mm



JZ-15232 Rsteel铁齿  
783NV 针织羊毛衫



JZ-15233 800A  
S37103-101 16mm  
S37102-101 25mm  
S37109-102 32mm



JZ-15234 1790  
400-08646 75mm  
80mm  
90mm  
100mm  
108mm  
127mm  
130mm  
146mm



JZ-15301 Sunstar



JZ-15304 Sunstar



JZ-15305 Sunstar



JZ-15307 JUKI 8800



JZ-15308 JUKI 1900(大)



JZ-15309 Brother 7200



JZ-15310 JUKI 9000A



JZ-15311 JUKI 9000



JZ-15312 JUKI 1900(小)



JZ-15313 JUKI 522



JZ-15314 JUKI 1903



JZ-15315 SINGER 457



JZ-15316 TYPICAL 6180



JZ-15317 JUKI 400-89647



JZ-15318 (矮)



JZ-15319 JACK A5





A9 打褶器  
JZ-15409



G900E 打褶器  
JZ-15410



平车切刀组 SC-735  
JZ-15414



SIRUBA 五线打褶器  
JZ-15415



JUKI 四线打褶器  
JZ-15416



JUKI 五线打褶器  
JZ-15417



SIRUBA 四线打褶器  
JZ-15412



PEGASUS 五线打褶器  
JZ-15413



JZ-15436 36900



JZ-15437 L32



JZ-15438 兄弟



JZ-15439 M700



PEGASUS L52  
JZ-15401



PEGASUS M600  
JZ-15402



PEGASUS M700  
JZ-15403



KINGTEX SH7000-4  
JZ-15404



KINGTEX SH7000-5  
JZ-15405



SIRUBA 747  
JZ-15406



SIRUBA 747 卷边器  
JZ-15407



SIRUBA 757  
JZ-15408



JZ-15418 PGL52-A型打折压脚



JZ-15419 380 定规



JZ-15420  
CW-8B GB-6 新款820定规



JZ-15421 平缝定规



JZ-15422 820D 定规



JZ-15423 AS-005993-00 定规



JZ-15424 340定规



JZ-15425 CW-8B GB-2 精工8B定规



JZ-15426 380B 定规



JZ-15435 810 定规



JZ-15411 GB-1 吊磅



MAQ-141000AO  
JZ-15441

JZ-15442



W500两孔  
JZ-15443



W500一孔  
JZ-15444



W500老款  
JZ-15445



星菱8885  
JZ-15446



W600  
JZ-15447



F007  
JZ-15448



**JINZEN®**

JZ-15440  
747辅助装置





JZ-15470

# JINZEN® One-stop solution

缝配服务一站式采购



JZ-15427



JZ-15428



JZ-15429



JZ-15430



JZ-15431



JZ-15432



JZ-15433



JZ-15434



JZ-15471



JZ-15472



JZ-15473



JZ-15450 917



JZ-15451  
373 Thick特厚



JZ-15464 多功能



JZ-15452 373大



JZ-15453 1903



JZ-15454 430D



JZ-15455 373



JZ-15465 373加厚



JZ-15456 373 立扣



JZ-15457 373平扣



JZ-15458 917立扣



JZ-15459 917平扣



JZ-15460 1903平扣



JZ-15461 1903立扣



JZ-15462 438立扣



JZ-15463 438平扣



# SEWING MACHINE SPARE PARTS

JINZEN®

One-stop solution

缝配服务一站式采购



SEWING  
MACHINE  
SPARE  
PARTS



**JZ-15501 A10 / S60**

平车直角包边筒 Right Angle Bias Binder

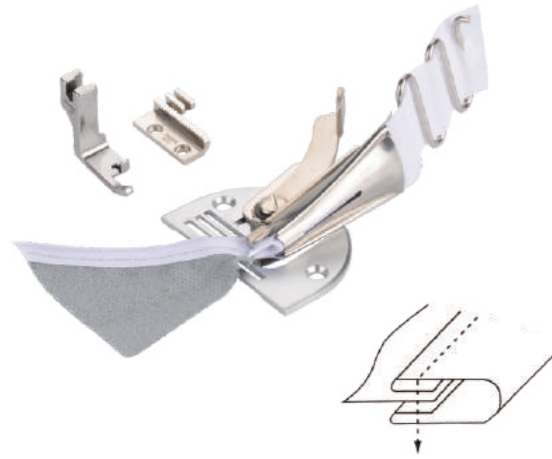

入口
16mm
18mm
20mm
22mm
24mm
26mm
28mm
30mm
32mm
34mm
36mm
38mm
40mm
45mm
50mm

作用: 细弯布边  
 用机: 单针平车  
 Purpose: Binding of curve edge  
 Machine: 1 Needle Lockstitch Machine  
 标准厚度:  
 Standard Thickness: M MH

**JZ-15499 A10H**

平车直角包边筒 Right Angle Bias Binder



出口	Tape Size	入口
6mm	15/16"	24mm
6.5mm	1"	26mm
7mm	1-1/8"	28mm
8mm	1-3/16"	30mm
8.5mm	1-1/4"	32mm
9.5mm	1-9/32"	34mm
10mm	1-3/8"	36mm
10.5mm	1-1/2"	38mm
11.5mm	1-1/16"	40mm
13mm	1-3/4"	45mm
16mm	2"	50mm

作用: 厚布料捆条布边  
 用机: 单针平车  
 Purpose: Binding of curve edge.  
 Machine: 1 Needle Lockstitch Machine

**JZ-15503 A11/S72L**

拉脚筒 Swing Hemmer



规格	
1/8"	1-1/8"
3/16"	1-3/16"
1/4"	1-1/4"
5/16"	1-3/8"
3/8"	1-1/2"
7/16"	1-5/8"
1/2"	1-3/4"
9/16"	1-7/8"
5/8"	2"
11/16"	
3/4"	
13/16"	
7/8"	
1"	

作用: 一般直折边用  
 用机: 单针平车  
 Purpose: General straight hemming  
 Machine: 1 Needle Lockstitch Machine  
 标准厚度:  
 Standard Thickness: M MH H

**JZ-15504 A70 / S70**

摆动式弹弓嘴卷边器  
 Spring Type Swing Hemmer



规格
1/8"
3/16"
1/4"
5/16"
3/8"
1/2"
5/8"

作用: 折边用, 筒嘴有弹性, 能容许厚骨通过  
 用机: 单针平车  
 Purpose: General hemming spring socket allows cross seam pass  
 Machine: 1 Needle Lockstitch Machine  
 标准厚度:  
 Standard Thickness: M MH H

**JZ-15500 A10 XH**

平车直角包边筒 Right Angle Bias Binder

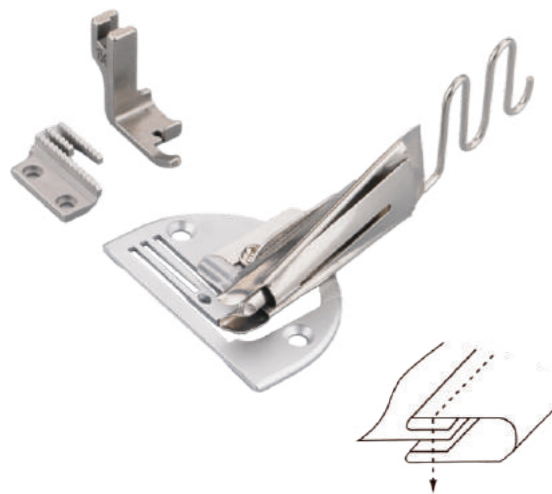

入口
16mm
18mm
20mm
22mm
24mm
26mm
28mm
30mm
32mm
34mm
36mm
38mm
40mm
45mm
50mm
55mm
60mm

作用: 细弯布边  
 用机: 单针平车  
 Purpose: Binding of curve edge  
 Machine: 1 Needle Lockstitch Machine

**JZ-15502 F531 / S64**

平车直角包边筒 (散口) Right Angle Bias Binder

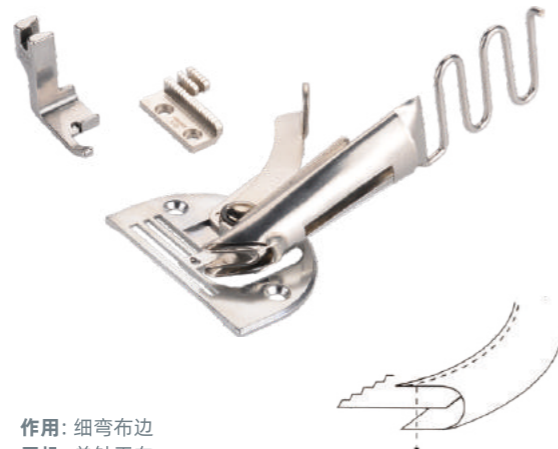

入口
12mm
14mm
15mm
16mm
18mm
20mm
22mm
24mm
25mm
26mm
28mm
30mm
32mm

作用: 细弯布边  
 用机: 单针平车  
 Purpose: Binding of curve edge  
 Machine: 1 Needle Lockstitch Machine  
 标准厚度:  
 Standard Thickness: M MH

**JZ-15505 F335 / A30 / 121586**

日字埋夹 Side Seam Folder-Japan Style



针距尺寸
1/8"
3/16"
1/4"
5/16"

作用: 埋夹  
 用机: 日本制2、3针埋夹车  
 Purpose: Sew side seam of thick material  
 Machine: Japan Made 2, 3 Needle Feed of the Arm Machine  
 标准厚度:  
 Standard Thickness: M MH H XH

**JZ-15506 F342**

切刀机耳仔筒  
 Belt Loop Folder for Belt Loop Machine with Cutter

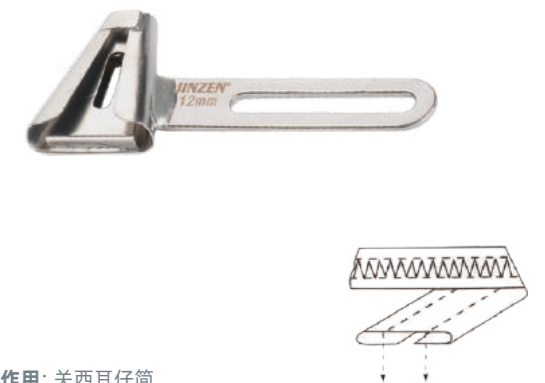

出口
8mm
9mm
10mm
11mm
12mm
13mm
14mm
15mm
16mm
17mm
18mm
20mm

作用: 关西耳仔筒  
 用机: 双针耳仔车连前切刀  
 Purpose: Beltloop Machine with Front Cutter  
 Machine: 2 Needle Belt Loop Machine with Front Cutter  
 标准厚度:  
 Standard Thickness: M MH H



**JZ-15507 F340**

耳仔筒 Belt Loop Folder

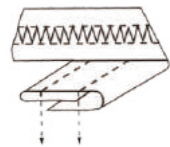

入口	出口
5/8"	1/4"
3/4"	5/16"
7/8"	3/8"
1"	7/16"
1-1/8"	1/2"
1-3/8"	5/8"
1-5/8"	3/4"
1-7/8"	7/8"
2-1/8"	1"

作用: 车耳仔  
用机: 双针耳仔车  
Purpose: Belt loop  
Machine: 2 Needle Belt Loop Machine  
标准厚度:  
Standard Thickness: M MH H

**JZ-15508 F339**

耳仔筒 Belt Loop Folder

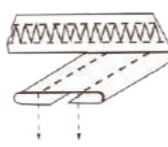

入口	出口
1/2"	1/4"
5/8"	5/16"
3/4"	3/8"
7/8"	7/16"
1"	1/2"
1-1/4"	5/8"
1-1/2"	3/4"
1-3/4"	7/8"
2"	1"
2-1/4"	1-1/8"
2-1/2"	1-1/4"

作用: 车耳仔  
用机: 双针耳仔车  
Purpose: Belt loop  
Machine: 2 Needle Belt Loop Machine  
标准厚度:  
Standard Thickness: M MH H

**JZ-15509 F524 At112**

双针面贴器 Double Needle Tape Attaching Foot

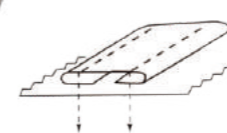

针距尺寸
1/8"
3/16"
1/4"
5/16"
3/8"
1/2"
5/8"
3/4"
7/8"
1"

作用: 车双针面贴  
用机: 双针车  
Purpose: Attach tape on top of fabric surface  
Machine: 2 Needle Machine  
标准厚度:  
Standard Thickness: M MH H

**JZ-15512 A4/100**

散口曲嘴包边筒 Edge Binder

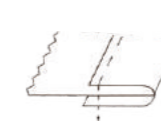

入口	出口
3/8"	3/16"
1/2"	1/4"
5/8"	5/16"
3/4"	3/8"
7/8"	7/16"
1"	1/2"
1-1/8"	9/16"
1-1/4"	5/8"
1-3/8"	11/16"
1-1/2"	3/4"

作用: 包硬身布料等  
用机: 单针平车  
Purpose: Binding of curve edge  
Machine: 1 Needle Lockstitch Machine  
标准厚度:  
Standard Thickness: M MH H

**JZ-15510A F402 / K710N (A)**

绷缝车直角包边筒 (插口单折可调)  
Right Angle Binder

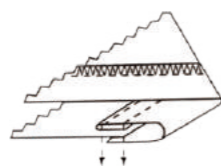

作用: 拉针织T恤领、袖等  
用机: 2或3针拉边车  
Purpose: Binding of knitwear collar and sleeve  
Machine: 2 or 3 Needle Cover Stitch Machine  
标准厚度:  
Standard Thickness: MH H

入口	3/4"	15/16"	1-1/8"	1-3/16"	1-3/8"	1-1/2"	1-5/8"	1-3/4"	1-7/8"	2-1/8"	2-3/8"	2-5/8"	2-3/4"	2-7/8"	3"	3-1/8"	3-3/8"
出口	1/4"	5/16"	3/8"	7/16"	1-1/2"	9/16"	5/8"	11/16"	3/4"	7/8"	1"	1-1/8"	1-3/16"	1-1/4"	1-5/16"	1-3/8"	1-1/2"

**JZ-15510B K712N (A)**

绷缝车直角包边筒 (平口单折可调)  
Right Angle Binder



**JZ-15511A F401 / K710NA (B)**

绷缝车直角包边筒 (插口双折可调)  
Right Angle Binder

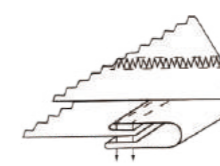

作用: 拉针织T恤领、袖等  
用机: 2或3针拉边车  
Purpose: Binding of knitwear collar and sleeve  
Machine: 2 or 3 Needle Cover Stitch Machine  
标准厚度:  
Standard Thickness: MH H

入口	1"	1-3/16"	1-3/8"	1-1/2"	1-5/8"	1-3/4"	1-7/8"	2"	2-1/8"	2-3/8"	2-3/4"	3"	3-1/8"	3-1/4"	3-3/8"	3-1/2"	3-3/4"
出口	1/4"	5/16"	3/8"	7/16"	1/2"	9/16"	5/8"	11/16"	3/4"	7/8"	1"	1-1/8"	1-3/16"	1-1/4"	1-5/16"	1-3/8"	1-1/2"



**JZ-15513 A9/508**

曲嘴包边筒(环口) Plain Bias Binder



作用: 边  
用机: 单针平车  
Purpose: Binding edge  
Machine: 1 Needle Lockstitch Machine  
标准厚度:  
Standard Thickness: M MH

入口	出口
3/4"	3/16"
1"	1/4"
1-1/4"	5/16"
1-1/2"	3/8"
1-3/4"	1/2"
2"	5/8"

**JZ-15514 DY124**

曲嘴包边筒(散口) Braid or Tape Binder



作用: 拉皮革塑胶织带  
用机: 单针平车  
Purpose: Edge Binder(Leather)  
Machine: 1-Needle Lockstitch Machine  
标准厚度:  
Standard Thickness: M MH H

入口	出口
1/2"	1/4"
5/8"	5/16"
3/4"	3/8"
7/8"	7/16"
1"	1/2"
1-1/8"	9/16"
1-1/4"	5/8"
1-3/8"	11/16"
1-1/2"	3/4"

**JZ-15516A S174**

祖奇包缝车包边筒(散口)  
Edge Binder for JUKI Overlock Machine

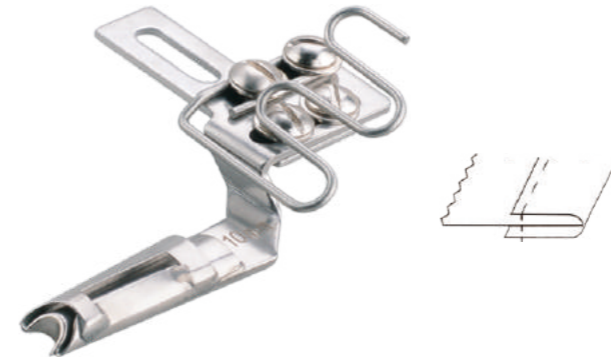

入口
1/2"

**JZ-15517**

祖奇包缝车包边筒  
Edge Binder for Pegasus Overlock Machine

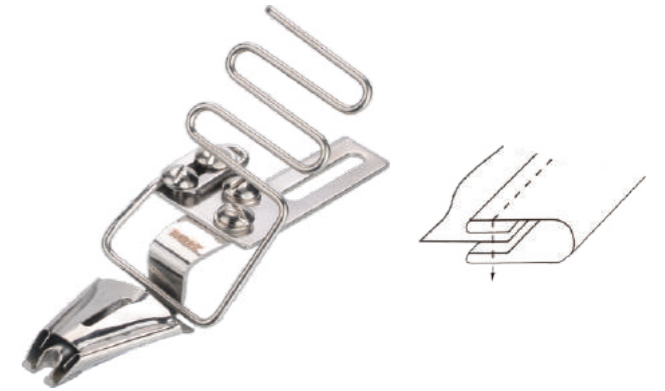

作用: 布边  
用机: 祖奇包缝车  
标准厚度:  
Standard Thickness: M

入口
20mm
22mm
24mm
26mm

**JZ-15515**

飞马包缝车包边筒  
Edge Binder for Pegasus Overlock Machine

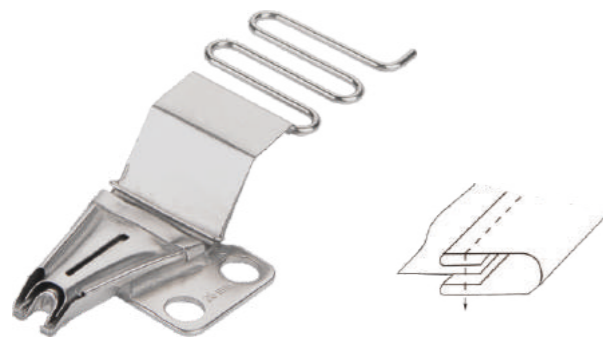

作用: 口袋边包缝  
用机: 飞马L22-0E  
Purpose: Pocket Binding  
Machine: Pegasus L22  
标准厚度:  
Standard Thickness: M

入口
22mm
24mm
26mm
28mm

**JZ-15516**

祖奇包缝车包边筒(散口)  
Edge Binder for JUKI Overlock Machine

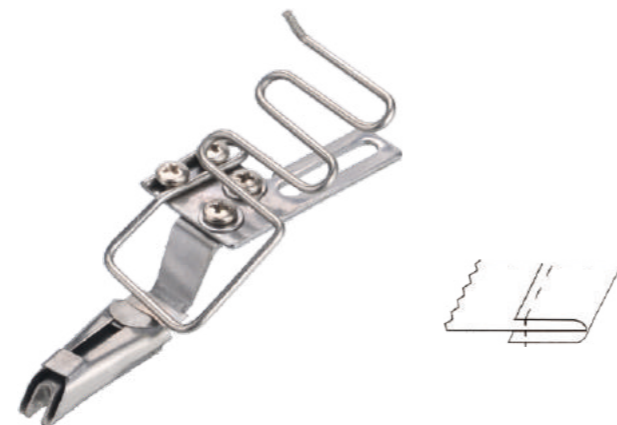

作用: 布边  
用机: 祖奇包缝车  
标准厚度:  
Standard Thickness: M

入口
1/2"

**JZ-15518**

散口鞋边包边筒 Single Needle Binders(for Shoes)

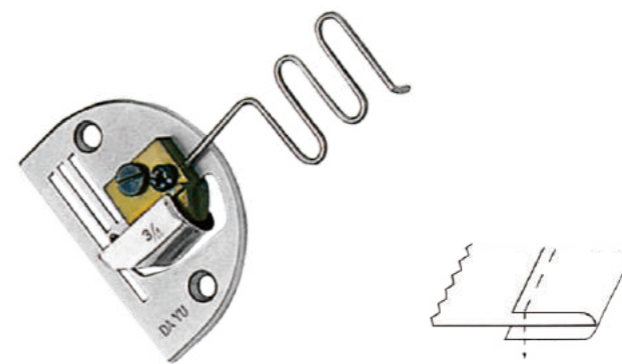

作用: 厚物、皮革及塑胶材料用  
用机: 单针平车  
Purpose: For Thick Leather and Rubber Material  
Machine: 1 Needle Lockstitch Machine  
标准厚度:  
Standard Thickness: H XH

入口
1/2"
5/8"
3/4"
7/8"
1"

**JZ-15518 F515**

平车靴头筒 Loop Folder Foot

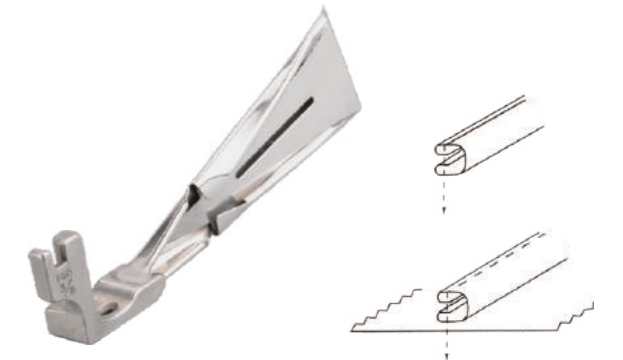

作用: 车耳仔  
用机: 单针平车  
Purpose: Loop sewing  
Machine: 1 Needle Lockstitch Machine  
标准厚度:  
Standard Thickness: M MH

入口	出口
1/2"	1/8"
3/4"	3/16"
1"	1/4"



**JZ-15520 F301**

裤头筒 Waist Band Folder

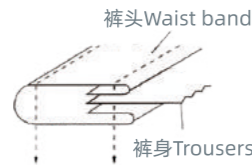

入口	出口
2-3/4"	1"
3"	1-1/8"
3-1/8"	1-3/16"
3-1/4"	1-1/4"
3-1/2"	1-3/8"
3-3/4"	1-1/2"
4"	1-5/8"
4-1/4"	1-3/4"
4-1/2"	1-7/8"
4-3/4"	2"

作用: 缝折裤头、裙头(没有朴)  
用机: 2或4针裤头车  
Purpose: Binding of waist band(without lining)  
Machine: 2 or 4 Needle Wsist Band Machine  
标准厚度:  
Standard Thickness: **MH** **H** **XH**

**JZ-15521 F303**

散底裤头筒 Waist Band Folder

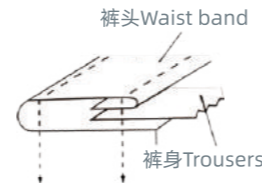

入口	出口
2-3/4"	1"
3"	1-1/8"
3-1/8"	1-3/16"
3-1/4"	1-1/4"
3-1/2"	1-3/8"
3-3/4"	1-1/2"
4"	1-5/8"
4-1/4"	1-3/4"
4-1/2"	1-7/8"
4-3/4"	2"

作用: 缝折裤头、裙头(散底、没有朴)  
用机: 2或4针裤头车  
Purpose: Binding of waist band  
(loose bottom,without lining)  
Machine: 2 or 4 Needle Waist Band Machine  
标准厚度:  
Standard Thickness: **MH** **H** **XH**

**JZ-15524 F514**

多条面贴器 Multi Tape Attach Folder



出口
5/16"
3/8"
7/16"
1/2"
9/16"
5/8"
3/4"
7/8"
1"

作用: 机恤装式面贴用  
用机: 多针车  
Purpose: Decorative tape on jacket  
Machine: Multi Needle Machine  
标准厚度:  
Standard Thickness: **M**

**JZ-15525 F337 / 35800**

弹弓嘴迂仁埋夹  
Sprig Type Side Seam Folder-Union Special Type

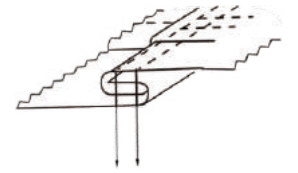

针距尺寸
3/16"MH
3/16"H
3/16"XH
1/4"MH
1/4"H
1/4"XH

作用: 埋夹  
用机: 迂仁2、3针埋夹车  
Purpose: Sew side seam  
Machine: 2,3 Needle Union Special Feed of the Arm Machine

**JZ-15522 U12**

雨伞筒 Twin Plain Hemmer

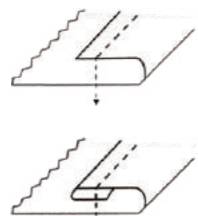

规格
2.5x3
3x3.5
3.5x4
4x5

作用: 拉伞边  
用机: 单针平车  
Purpose: Umbrella Edge Hemmer  
Machine: 1-Needle Lock Stitch Machine  
标准厚度:  
Standard Thickness: **M**

**JZ-15523 A32**

双针上袖筒 Double Needle Lap Seam Folder

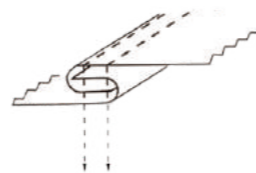

针距尺寸
3/16"M
3/16"MH
3/16"H
1/4"M
1/4"MH
1/4"H

作用: 缝薄布或恤衫后幅  
用机: 双针车  
Purpose: Back seam of shirt or light weight fabric  
Machine: 2 Needle Machine

**JZ-15526 F404**

绷缝车直角包边筒(插管子母筒单折可调)  
Right Angle Binder with Piping -Loose Bottom

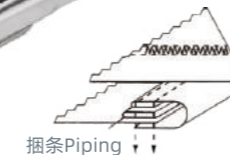
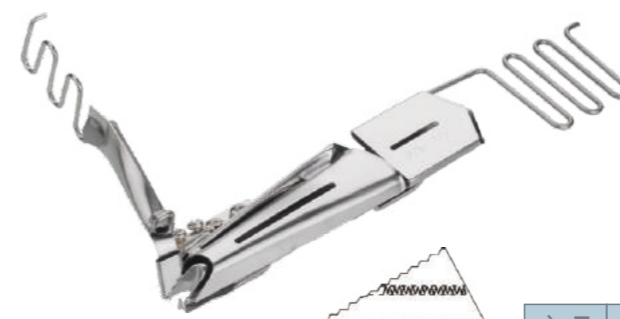

入口	出口
3/4"	1/4"
15/16"	5/16"
1-1/8"	3/8"
1-3/16"	7/16"
1-3/8"	1/2"
1-1/2"	9/16"
1-5/8"	5/8"
1-3/4"	11/16"
1-7/8"	3/4"
2-1/8"	7/8"
2-3/8"	1"

作用: 拉针织T恤领、袖、连捆条  
用机: 2或3针拉包车  
Purpose: Binding of knitwear collar and sleeve with piping.  
Machine: 2 or 3 Needle Cover Stitch Machine  
标准厚度:  
Standard Thickness: **MH** **H**

**JZ-15527 F403**

绷缝车直角包边筒(插管子母筒单折可调)  
Right Angle Binder with Piping

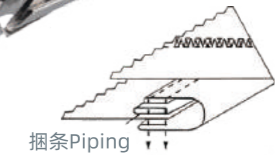

入口	出口
1"	1/4"
1-3/16"	5/16"
1-3/8"	3/8"
1-1/2"	7/16"
1-5/8"	1/2"
1-3/4"	9/16"
1-7/8"	5/8"
2"	11/16"
2-1/8"	3/4"
2-3/8"	7/8"
2-3/4"	1"

作用: 拉针织T恤领、袖、连捆条  
用机: 2或3针拉包车  
Purpose: Binding of knitwear collar and sleeve with piping.  
Machine: 2 or 3 Needle Cover Stitch Machine  
标准厚度:  
Standard Thickness: **MH** **H**



**JZ-15528 F219**

侧袖筒 Sleeve Placket Binder

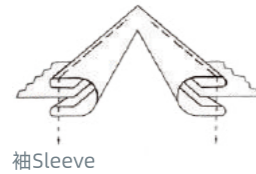

袖Sleeve

入口	出口
3/4"	3/16"
1"	1/4"
1-1/8"	5/16"
1-1/4"	3/8"
1-3/8"	7/16"
1-5/8"	1/2"
1-7/8"	5/8"
2-1/4"	3/4"
2-1/2"	7/8"
2-3/4"	1"

作用: 缝袖侧  
 用机: 单针平车  
**Purpose:** Attach sleeve placket.  
**Machine:** 1 Needle Lockstitch Machine  
 标准厚度:  
**Standard Thickness:** M MH H

**JZ-15529 F302**

裤头筒有补 Waist Band Folder With Lining

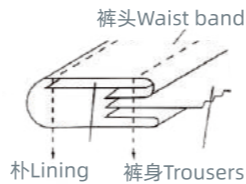

裤头Waist band  
 补Lining 裤身Trousers

入口	出口
2-3/4"	1"
3"	1-1/8"
3-1/8"	1-3/16"
3-1/4"	1-1/4"
3-1/2"	1-3/8"
3-3/4"	1-1/2"
4"	1-5/8"
4-1/4"	1-3/4"
4-1/2"	1-7/8"
4-3/4"	2"

作用: 缝折裤头, 裙头(有补)  
 用机: 2或4针裤头车  
**Purpose:** Hemming waist band with elastic  
**Machine:** 2,3,4 Needle Elastic Machine  
 标准厚度:  
**Standard Thickness:** MH H XH

**JZ-15586 F510**

工字摺缝器 Box Pleat Folder

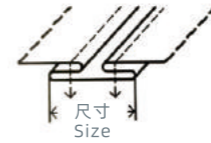
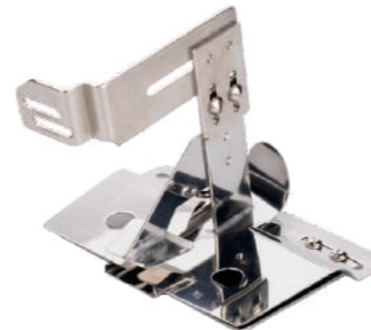

尺寸 Size

尺寸
1/2
5/8
3/4
7/8
1
1-1/8
1-1/4

作用: 车工字摺  
 用机: 双针车  
**Purpose:** Sew box pleat  
**Machine:** 2 Needle Machine

**JZ-15535 F521**

活动绳子筒 Piping Folder

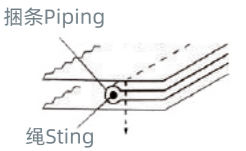

捆条Piping  
 绳Sting

入口	出口
3/8"	3/16"
1/2"	1/4"
5/8"	5/16"
3/4"	3/8"
7/8"	7/16"
1"	1/2"
1-1/8"	9/16"
1-3/16"	19/32"
1-1/4"	5/8"
1-3/8"	11/16"
1-1/2"	3/4"
1-5/8"	13/16"
1-3/4"	7/8"

作用: 车捆条连绳仔, 用于睡衣, 枕头袋等  
 用机: 单针平车  
**Purpose:** Attach piping with sting e.g.pajama and pillow case  
**Machine:** 1 Needle Lockstitch Machine  
 标准厚度:  
**Standard Thickness:** M MH H

**JZ-15530 F304**

散底裤头筒有补 Waist Band Folder With Lining

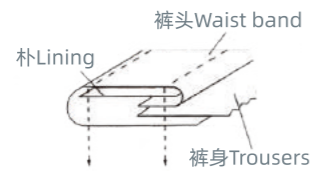

裤头Waist band  
 补Lining 裤身Trousers

入口	出口
2-3/4"	1"
3"	1-1/8"
3-1/8"	1-3/16"
3-1/4"	1-1/4"
3-1/2"	1-3/8"
3-3/4"	1-1/2"
4"	1-5/8"
4-1/4"	1-3/4"
4-1/2"	1-7/8"
4-3/4"	2"

作用: 缝折裤头, 裙头(散底, 有补)  
 用机: 2或4针裤头车  
**Purpose:** Binding of waist band (loose bottom, with lining.)  
**Machine:** 2 or 4 Needle Waist Band Machine  
 标准厚度:  
**Standard Thickness:** MH H XH

**JZ-15533 F218**

单针接袖器(单针车用) Single Needle Sleeve Attachment(Single Needle Operation)

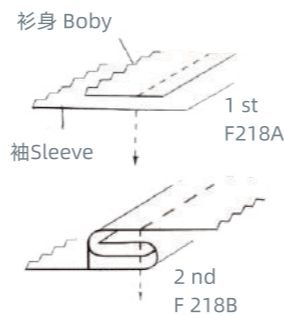

衫身 Body  
 袖Sleeve  
 1 st F218A  
 2 nd F218B

出口
1/4"
5/16"
3/8"

作用: 单针袖  
 用机: 单针平车  
**Purpose:** Single Needle Sleeve Attachment  
**Machine:** 1 Needle Lockstitch Machine  
 标准厚度:  
**Standard Thickness:** M MH

**JZ-15536 F201**

门襟筒 Top Center Plait Folder

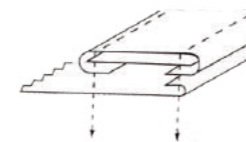

入口	出口
1-1/2"	3/4"
1-3/4"	7/8"
2"	1"
2-1/8"	1-1/8"
2-1/4"	1-1/4"
2-3/8"	1-5/16"
2-3/8"	1-3/8"
2-1/2"	1-1/2"
2-5/8"	1-5/8"
2-3/4"	1-3/4"

作用: 男女衫前胸明筒一有补  
 用机: 2或4针筒车  
**Purpose:** Top center plait of shirt and blouse - with lining  
**Machine:** 2 or 4 Needle Machine Placket  
 标准厚度:  
**Standard Thickness:** M MH

**JZ-15537 F307**

上下布裤头筒 Two Pieces Waist Band Folder

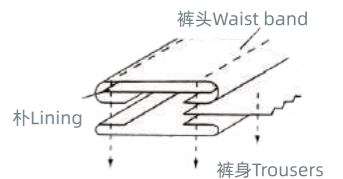

裤头Waist band  
 补Lining 裤身Trousers

入口	出口
2"	1"
2-1/8"	1-1/8"
2-1/4"	1-1/4"
2-3/8"	1-3/8"
2-1/2"	1-1/2"
2-5/8"	1-5/8"
2-3/4"	1-3/4"
2-7/8"	1-7/8"
3"	2"

作用: 缝折裤头  
 用机: 2或4针裤头车  
**Purpose:** Attach waist band.  
**Machine:** 2 or 4 Needle Waist Band Machine  
 标准厚度:  
**Standard Thickness:** M MH



**JZ-15538 F308**

上下布弯裤头筒  
Two Pieces Curve Waist Band Folder

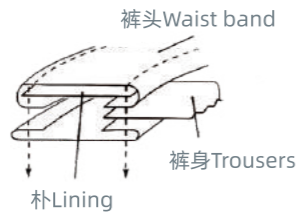

作用: 缝折弯裤头  
用机: 2或4针裤头车  
Purpose: Attach curve waist band.  
Machine: 2 or 4 Needle waistBand Machine  
标准厚度:  
Standard Thickness: **H** **XH**

入口	出口
2-1/4"	1-1/4"
2-3/8"	1-3/8"
2-1/2"	1-1/2"
2-5/8"	1-5/8"
2-3/4"	1-3/4"

**JZ-15539 443**

绷缝车捆条面贴器  
Tape Attach Folder for Covering Stitch

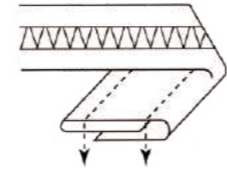
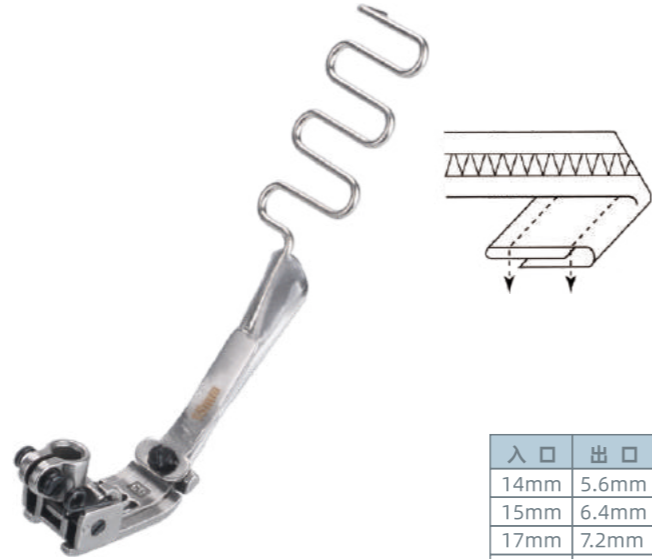

入口	出口
14mm	5.6mm
15mm	6.4mm
17mm	7.2mm
19mm	8.0mm
21mm	8.8mm

**JZ-15545 F538**

三尖侧贴筒 Triangular Sleeve Placket Folder

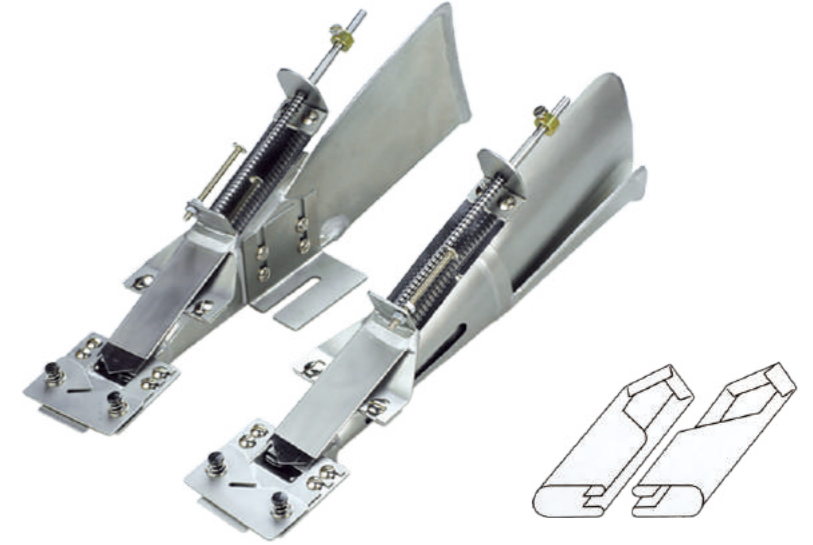

作用: 折三尖侧贴  
用机: 热压辊机  
Purpose: Fold triangular sleeve placket  
Machine: Hot Roll Machine  
标准厚度:  
Standard Thickness: **MH** **H** **XH**

**JZ-15543 KS177**

帽子助缝器 Hat & Cap Attachment

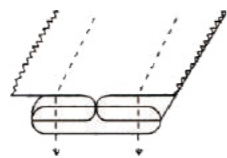

作用: 车帽开骨  
用机: 2、4针车用  
Purpose: Hat Folder  
Machine: 2、4 Needle Machine

入口
1"
1-1/8"

**JZ-15544 F535**

暗机耳仔筒 Spaghetti Attachment

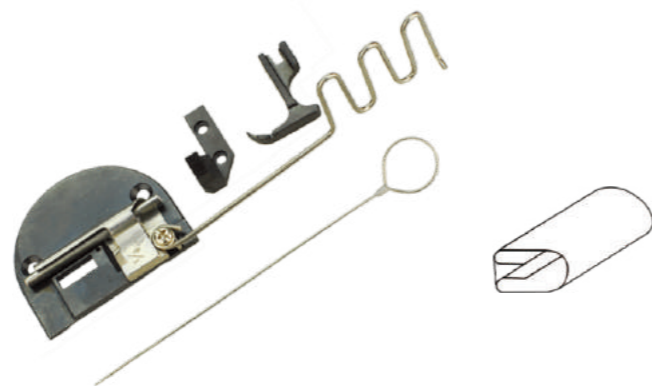

作用: 车暗线耳仔筒  
用机: 车针平车  
Purpose: Make spaghetti like tube.  
Machine: 1 Needle Lockstitch Machine  
标准厚度:  
Standard Thickness: **M**

入口	出口
1/2"	1/8"
3/4"	3/16"
1"	1/4"
1-1/4"	5/16"
1-3/8"	3/8"
1-3/4"	1/2"

**JZ-15546 KS232**

平车打条器 Pin Tuck Attachment



作用: 暗线打条  
用机: 单针平车  
Purpose: Loop sewing  
Machine: 1 Needle Lockstitch Machine  
标准厚度:  
Standard Thickness: **T** **MT**

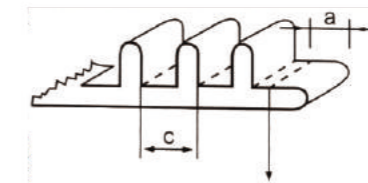

MF 533		
SIZE (inch)	a	1/16 - 1
	c	1/8 - 11/2



**JZ-15547**

PTV 多针打褶器

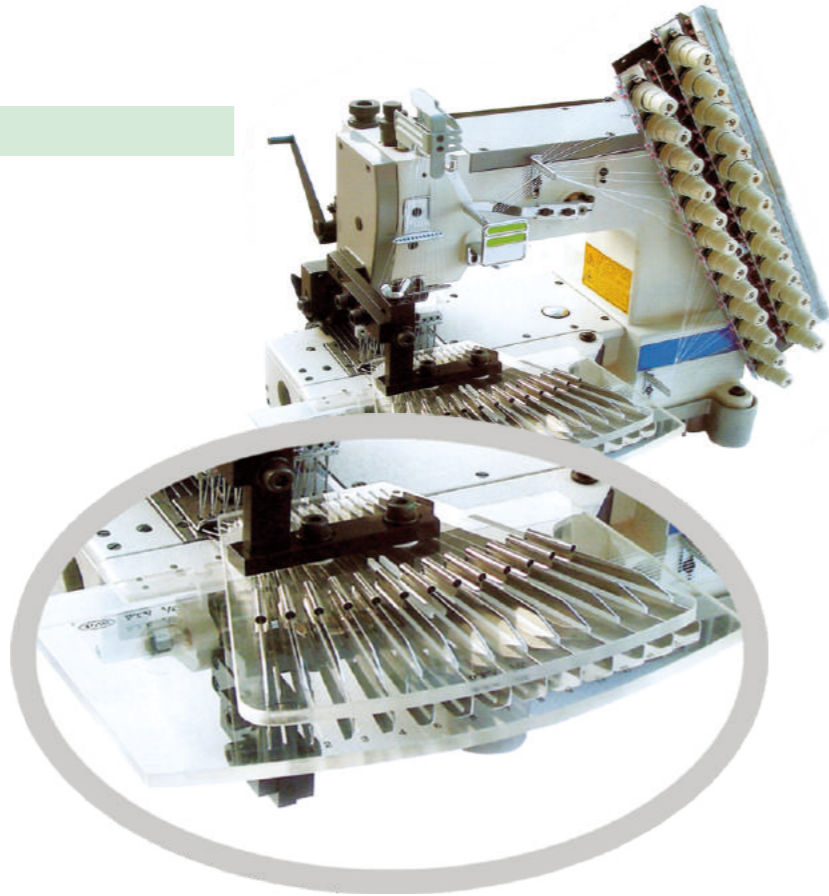

6针	3/8 (9.5mm)	1/2 (12.7mm)	
12针	3/16 (4.8mm)	1/4 (6.4mm)	
16针	3/16 (4.8mm)		
21针	1/8 (3.2mm)		
25针	3/16 (4.8mm)	1/4 (6.4mm)	3/16 (4.8mm)

**JZ-15554 P024**



FINISH
12mm
15mm

**JZ-15555 P031**

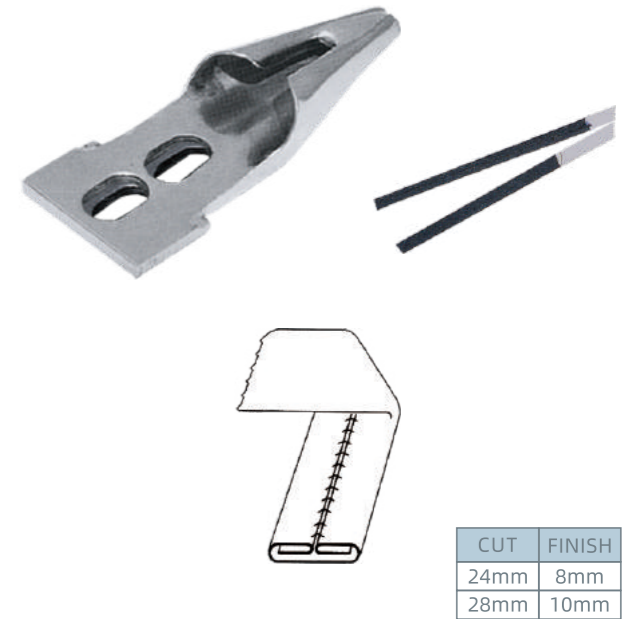

CUT	FINISH
24mm	8mm
28mm	10mm

**JZ-15549 E126**



CUT	FINISH
40mm	20mm
45mm	22mm
50mm	25mm
55mm	27mm
60mm	30mm
65mm	32mm
70mm	35mm
75mm	37mm
80mm	40mm
85mm	42mm
90mm	45mm
95mm	47mm
100mm	50mm
105mm	52mm
110mm	55mm

**JZ-15551 P007**



CUT	FINISH
55mm	18mm
60mm	20mm
70mm	25mm
85mm	30mm
95mm	35mm
100mm	40mm
110mm	42mm
120mm	45mm
125mm	50mm

**JZ-15556 P032**



CUT	FINISH
25mm	10mm
28mm	12mm
30mm	13mm
35mm	15mm
38mm	17mm
45mm	20mm

**JZ-15557 P040**

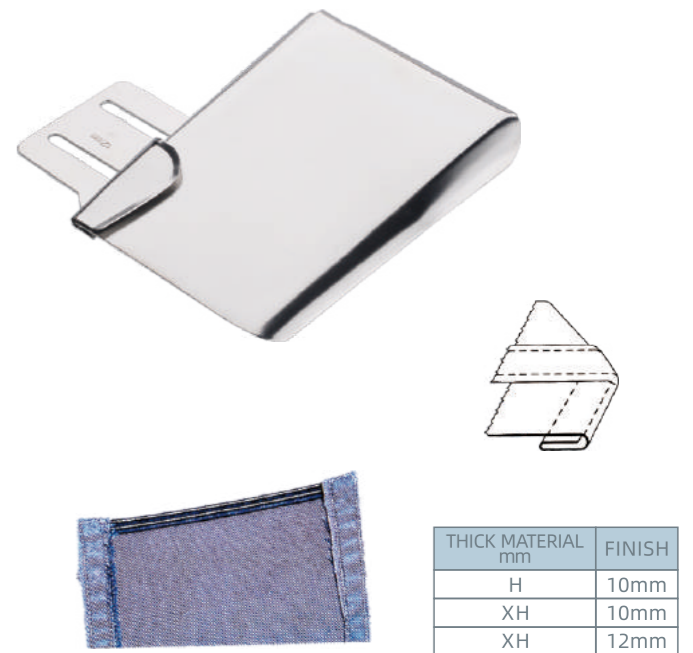

THICK MATERIAL mm	FINISH
H	10mm
XH	10mm
XH	12mm



**JZ-15567**

411棒球帽拉筒



**JZ-15568**

军帽拉筒



**JZ-15569 P039**



**JZ-15572**

雪纺包边压脚



作用: 适合薄料快速卷边  
用机: 工业平车/电脑平车通用

规格
1/8
3/16
3/8
5/16
5/32
1/4

**JZ-15574 490359**

弹弓咀押脚筒 Spring Hemmer Feet

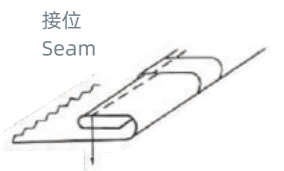

用机: 单针平车  
Machine: 1 Needle Lockstitch Machine

出口
1/16
1/8
3/16
1/4

**JZ-15570**

单针袋口折边器

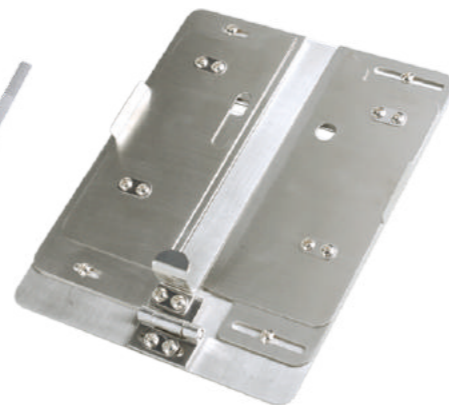
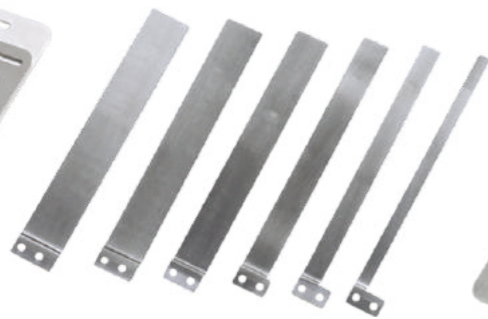
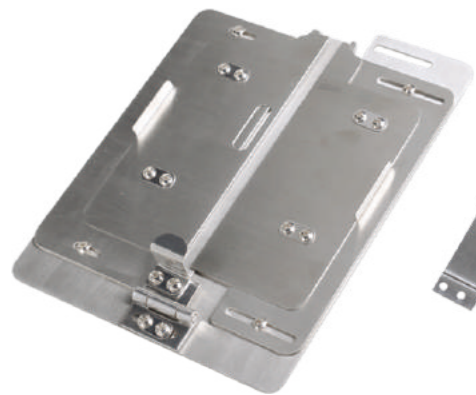

**JZ-15571**

双针袋口折边器

**JZ-15575 490358**

球型压脚筒 Ball Hemmer Feet

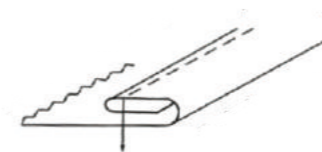

用机: 单针平车  
Machine: 1 Needle Lockstitch Machine

出口
1/16
1/8
3/16
1/4

**JZ-15587 F523**

双针面贴筒 Tape Attaching Folder Foot

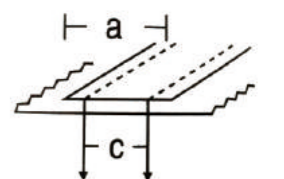

作用: 车双针面贴  
用机: 双针车用  
Purpose: Attach tape on top of fabric surface e.g. jogging suit.  
Machine: 2 Needle Machine

尺寸Size(寸inch)	
a	c
1/4	1/8
5/16	3/16
3/8	1/2
1/2	3/8
5/8	1/2
3/4	5/8
7/8	3/7
1	7/8
1-1/8	1



**JZ-15588 S10A**

单针可调面贴筒 Adjustable Tape Foot



规格
S10A-1/8"
S10A-3/16"
S10A-1/4"
S10A-5/16"
S10A-3/8"
S10A-7/16"
S10A-1/2"
S10A-9/16"
S10A-5/8"
S10A-3/4"
S10A-7/8"
S10A-1"

用机: 单针平车用  
Machine: 1 Needle Lockstitch Machine

**JZ-15576 K10**

活动双摺包边捆条筒  
Adjustable Double Fold Right Angle

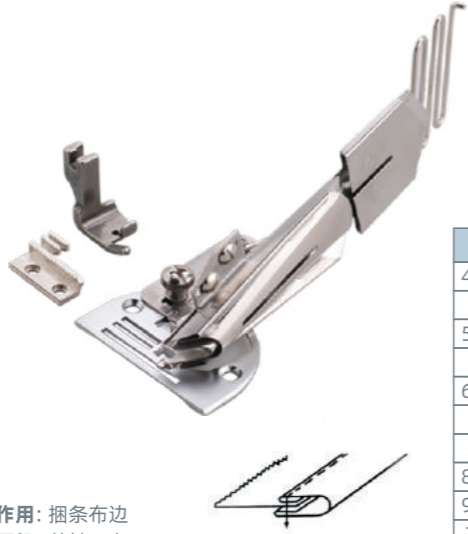

出口	入口	
4.5mm	11/16"	18mm
5mm	3/4"	20mm
5.5mm	7/8"	22mm
6mm	15/16"	24mm
6.5mm	1"	26mm
7mm	1-1/8"	28mm
8mm	1-3/16"	30mm
8.5mm	1-1/4"	32mm
9.5mm	1-19/32"	34mm
10mm	1-3/8"	36mm
10.5mm	1-1/2"	38mm
11.5mm	1-5/8"	40mm
13mm	1-3/4"	45mm
16mm	2"	50mm

作用: 捆条布边  
用机: 单针平车  
Purpose: Binding of curve edge  
Machine: 1 Needle Lockstitch Machine  
标准厚度: M MH

**JZ-15589 F502 钢丝**

拉圆脚跌入靴  
Swing Hemmer Foot

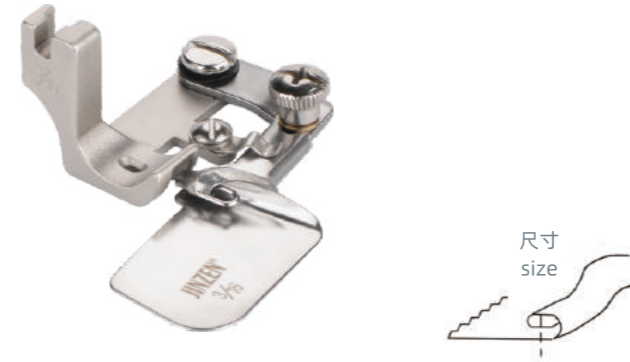

尺寸 size

尺寸
1/8
3/16
1/4

用机: 单针平车  
Machine: 1 Needle Lockstitch Machine

**JZ-15590 AT18A**

细筒筒型车包边器  
Binder for Small - sized Cylinder Bed Machine

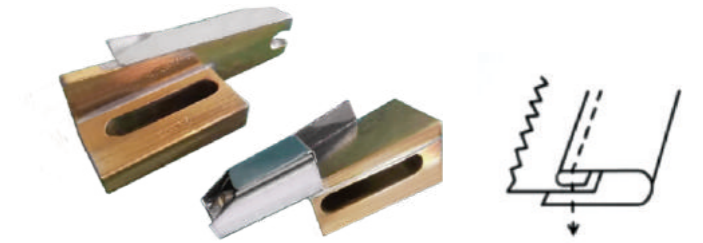

入口
16mm
18mm
20mm
22mm
24mm
26mm
28mm
30mm

作用: 皮革及塑料材料用  
用机: 335高头车用  
Purpose: For Thin Leather and Plastic Material  
Machine: 1 Needle Lockstitch Machine

**JZ-15577 S91/DY503**

松紧带拉脚筒 Also Available

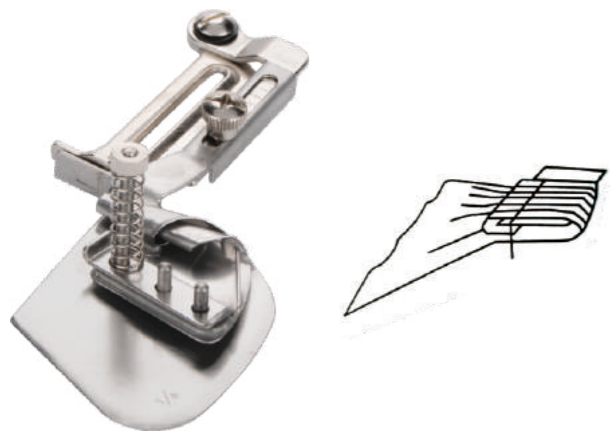

作用: 松紧带摺边  
用机: 单针平车  
Purpose: Single up tum folding of general purpose e.g.  
Machine: 1 Needle Lockstitch Machine

出口
1/4
5/16
3/8
1/2

**JZ-15578 F527**

双针车吊筒 Tape Attaching Folder

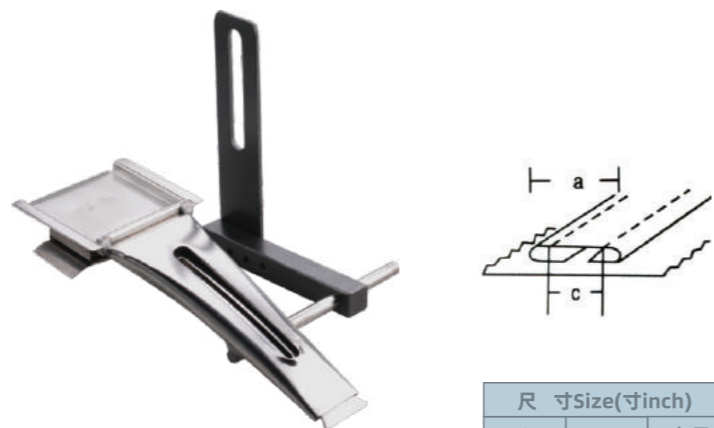

尺寸Size(寸inch)		
a	c	入口
3/8	1/4	7/8
1/2	3/8	1-1/8
5/8	1/2	1-3/8
3/4	5/8	1-1/2
7/8	3/4	1-5/8
1	7/8	1-3/4
1-1/8	1	1-7/8

作用: 车双针面贴  
用机: 双针车用  
Purpose: Attach tape on top of fabric e.g. jogging suit.  
Machine: 2 Needle Machine

**JZ-15591 AT18B**

细筒筒型车包边器  
Binder for Small - sized Cylinder Bed Machine

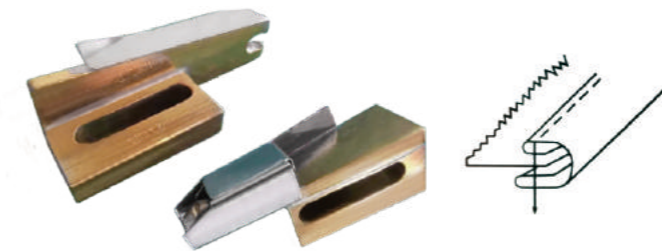

入口
16mm
18mm
20mm
22mm
24mm
26mm
28mm
30mm

作用: 皮革及塑料材料用  
用机: 335高头车用  
Purpose: For Thin Leather and Plastic Material  
Machine: 1 Needle Lockstitch Machine

**JZ-15592 AT18C**

细筒筒型车包边器  
Binder for Small - sized Cylinder Bed Machine

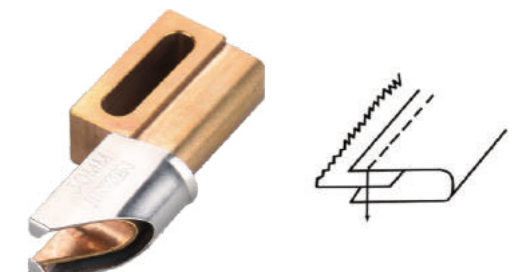

入口
12mm
14mm
16mm
18mm
20mm
22mm
24mm
26mm
28mm
30mm
32mm
34mm
36mm

作用: 皮革及塑料材料用  
用机: 335高头车用  
Purpose: For Thin Leather and Plastic Material





JZ-15579 A608



JZ-15593 A609



JZ-15580 A607



JZ-15595  
手指反领器



JZ-15596  
新款定位  
防止外翻拉筒A



JZ-15597  
新款定位  
防止外翻拉筒B



JZ-15598  
新款定位  
防止外翻拉筒C



JZ-15594 RAJ定做拉筒  
包缝机折痕拉筒



JZ-15581  
拉链定规



JZ-15582  
拉链定规



JZ-15599  
DY602-a



JZ-15600  
免烫卷边筒



JZ-15601  
落坑暗线挡边-薄布



JZ-15602  
新款厚薄两用定规



JZ-15583 B815

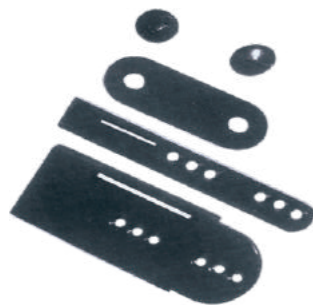

JZ-15584 B818



JZ-15585



JZ-15603  
多功能定规厚薄可调



JZ-15604  
防卷边定规-银箭



JZ-15605  
定做



**JZ-15606 F204**

假反筒 Immitation Folder



**作用:** 男女衫前胸明筒-有襟  
**用机:** 2或4针筒车  
**Purpose:** Top center plait of shirt and blouse-with lining.  
**Machine:** 2 or 4 Needle Placket Machine  
**标准厚度:**  
**Standard Thickness:** S M L

出口
1"
1-1/8"
1-3/16"
1-1/4"
1-3/8"
1-1/2"
1-5/8"

**JZ-15607 F206**

拉钮子筒 Plait Folder

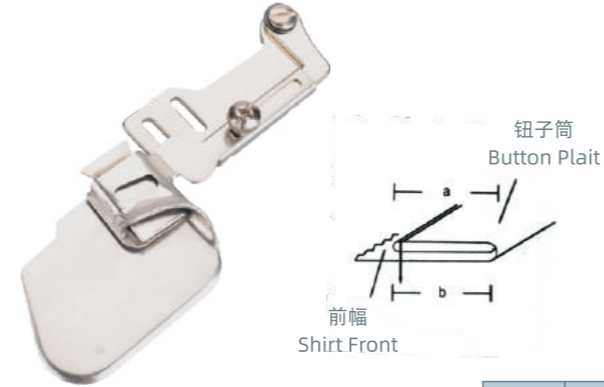

**作用:** 加长纸口代替补布, 能用于恤衫筒  
**用机:** 单针平车  
**Purpose:** Full margin serve same purpose of interlining. Use on shirt placket.  
**Machine:** 1 Needle Lockstitch Machine  
**标准厚度:** T MT

尺寸	寸
a	b
7/8	13/16
1	15/16
1-1/8	1-1/16
1-3/16	1-1/8
1-1/4	1-3/16
1-3/8	1-5/16
1-1/2	1-7/16

**JZ-15610 F224**

袖口接逢器 Cuff Setter



**作用:** 上袖口  
**用机:** 单针平车  
**Purpose:** Attach cuff to sleeve.  
**Machine:** 1 Needle Lockstitch Machine

**JZ-15611 DY105**

绷缝车直角包边筒(插口散口可调)  
Right Angle Binder

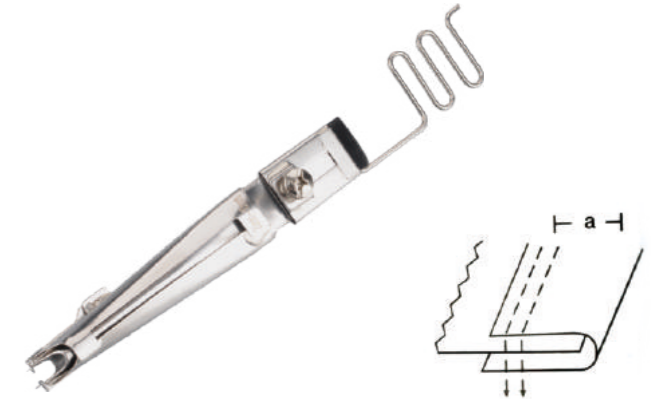

**作用:** 拉橡筋、针织T恤领、袖等  
**用机:** 2或3针拉坎车  
**Purpose:** Binding of knitwear collar and sleeve with (elastic)  
**Machine:** 2 or 3 Needle Cover Stitch Machine

入口	出口
1/2"	1/4"
5/8"	5/16"
3/4"	3/8"
7/8"	7/16"
1"	1/2"

**JZ-15608 F207**

拉钮子筒有朴 Plait Folder with Interlining

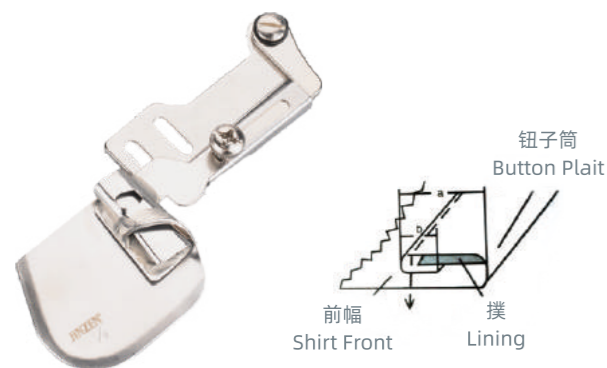

**作用:** 男女恤钮子筒-有朴  
**用机:** 单针平车  
**Purpose:** Button plait with interlining  
**Machine:** 1 Needle Lockstitch Machine  
**标准厚度:**  
**Standard Thickness:** T TM

尺寸
3/4
7/8
1
1-1/8
1-3/16
1-1/4
1-3/8
1-1/2

**JZ-15609 F213**

单针捍杆筒  
Single Needle Shirt Yoke Attachment

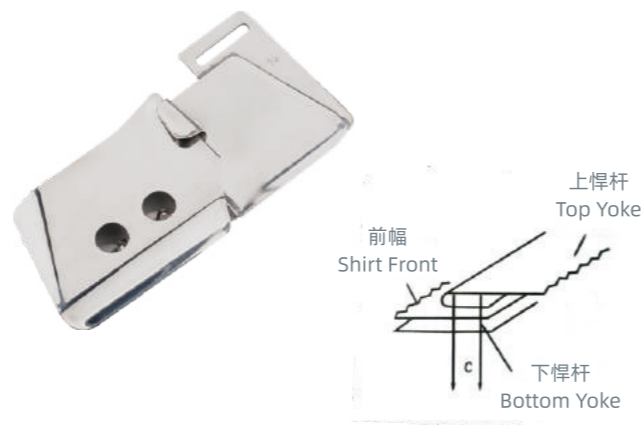

**作用:** 单针明线缝捍杆及后幅  
**用机:** 单针平车  
**Purpose:** Single needle top stitch attach of yoke to back shirt.  
**Machine:** Single Needle Lockstitch Machine  
**标准厚度:**  
**Standard Thickness:** M MH

规格
3/8"

**JZ-15612 A5**

车带筒 Belt Folder



**作用:** 缝腰带  
**用机:** 单针平车  
**Purpose:** Attach sleeve placket.  
**Machine:** 1 Needle Lockstitch Machine

入口	出口
18mm	5mm
26mm	8mm
30mm	10mm
36mm	12mm
45mm	15mm
52mm	18mm
58mm	20mm
64mm	22mm
70mm	24mm
82mm	30mm

**JZ-15613 A5B**

缝袖叉筒 Sleeve Placket Binder

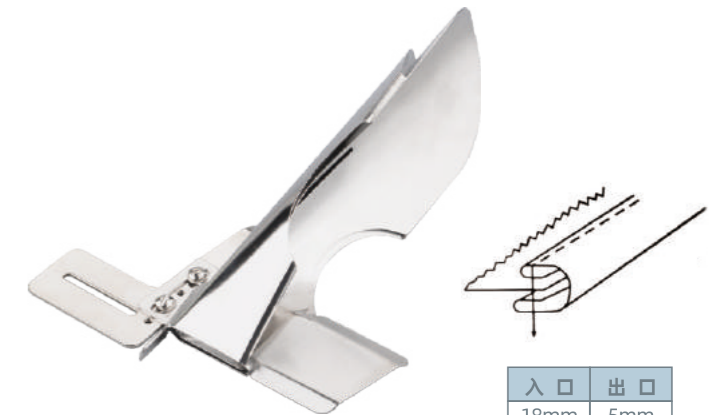

**作用:** 缝袖侧  
**用机:** 单针平车  
**Purpose:** Attach sleeve placket.  
**Machine:** 1 Needle Lockstitch Machine

入口	出口
18mm	5mm
26mm	8mm
30mm	10mm
36mm	12mm
45mm	15mm
52mm	18mm
58mm	20mm
64mm	22mm
70mm	24mm
82mm	30mm



### JZ-15614

散口鞋边包边筒 Single Needle Binders(for Shoes)  
(平车)

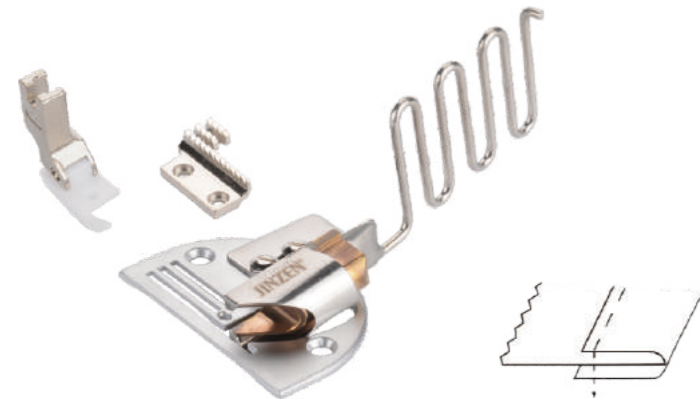

作用: 厚物、皮革及塑胶材料用  
用机: 单针平车  
Purpose: For Thick Leather and Rubber Material  
Machine: 1 Needle Lockstitch Machine  
标准厚度: **H** **XH**

入口
1/2"
5/8"
3/4"
7/8"
1"

### JZ-15615 LP-2

散口鞋边包边筒 Single Needle Binders(for Shoes)  
(同步车)

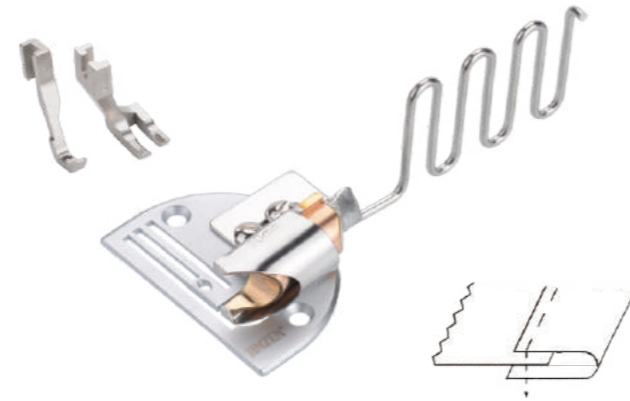

作用: 厚物、皮革及塑胶材料用  
用机: 单针同步车  
Purpose: For Thick Leather and Rubber Material  
Machine: Single needle synchronous car  
标准厚度: **H** **XH**

尺寸
30mm

### JZ-15616 KS-171

钹骨捆条筒Piping Folder



作用: 车捆条, 用于裤骨针织T恤等  
用机: 4或5线钹骨车  
Purpose: Attach piping with sting e.g. pajama and pillow case  
Machine: 1 Needle Lockstitch Machine  
标准厚度: **MH** **H** **XH**

入口	出口
3/4"	3/8"
7/8"	7/16"
1"	1/2"
1-1/4"	5/8"
1-1/2"	3/4"

### JZ-15617 KS 173-S

绳仔筒 Piping Folder

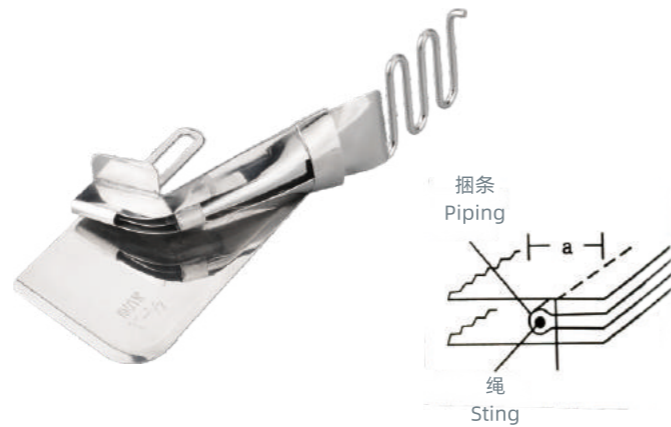

作用: 车捆条连绳仔, 用于睡衣, 枕头袋等  
用机: 4或5线钹骨车  
Purpose: Attach piping with sting e.g. pajama and pillow case.  
Machine: 1 Needle Lockstitch Machine

尺寸Size(寸inch)		
a	入口	绳
3/8	3/4	1/4
7/16	7/8	
1/2	1	3/16
5/8	1-1/4	

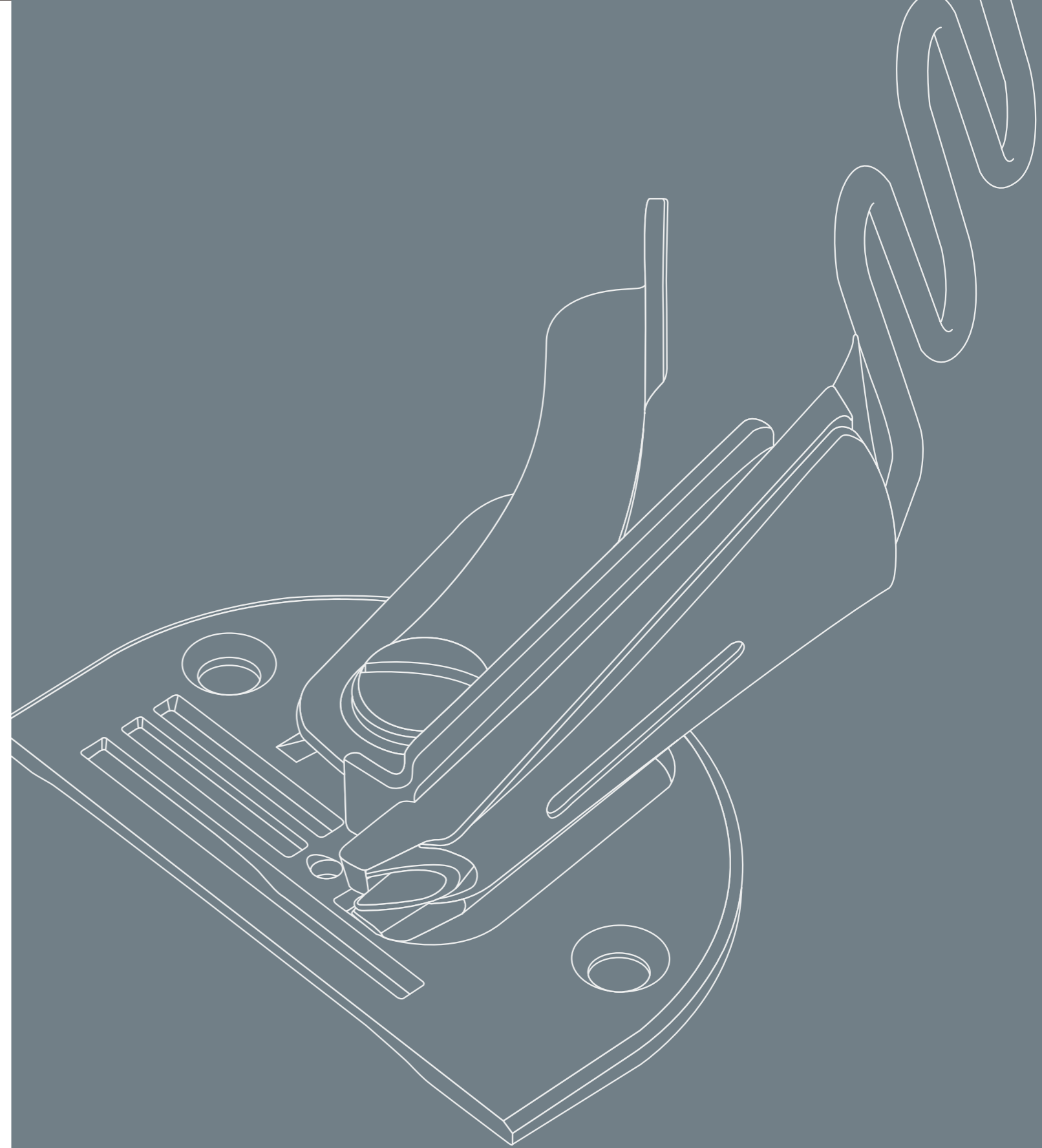

**JINZEN®**





JZ-15651



JZ-15652



JZ-15653



JZ-15654



JZ-15655



JZ-15676



JZ-15677



JZ-15678



JZ-15679



JZ-15680



JZ-15656



JZ-15657



JZ-15658



JZ-15659



JZ-15660



JZ-15681



JZ-15682



JZ-15683



JZ-15684



JZ-15685



JZ-15661



JZ-15662



JZ-15663



JZ-15664



JZ-15665



JZ-15686



JZ-15687



JZ-15688



JZ-15689



JZ-15690



JZ-15666



JZ-15667



JZ-15668



JZ-15669



JZ-15670



JZ-15691



JZ-15692



JZ-15693



JZ-15694



JZ-15695



JZ-15671



JZ-15672



JZ-15673



JZ-15674



JZ-15675



JZ-15696



JZ-15697



JZ-15698



JZ-15699



JZ-15700





JZ-15801



JZ-15802



JZ-15803



JZ-15804



JZ-15805



JZ-15806



JZ-15807



JZ-15808



JZ-15809



JZ-15810



JZ-15811



JZ-15812



JZ-15813



JZ-15814



JZ-15815



JZ-15816



JZ-15817



JZ-15818



JZ-15819



JZ-15820



JZ-15821



JZ-15822



JZ-15823



JZ-15824



JZ-15825



JZ-15826



JZ-15827



JZ-15828



JZ-15829



JZ-15830

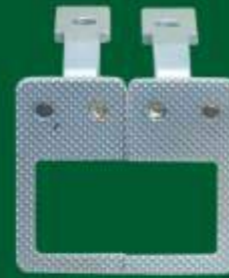

JZ-15831



JZ-15832



JZ-15833



JZ-15834



JZ-15835



JZ-15836



JZ-15837

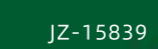

JZ-15838



JZ-15839



JZ-15840



JZ-15841



JZ-15842



JZ-15843



JZ-15844

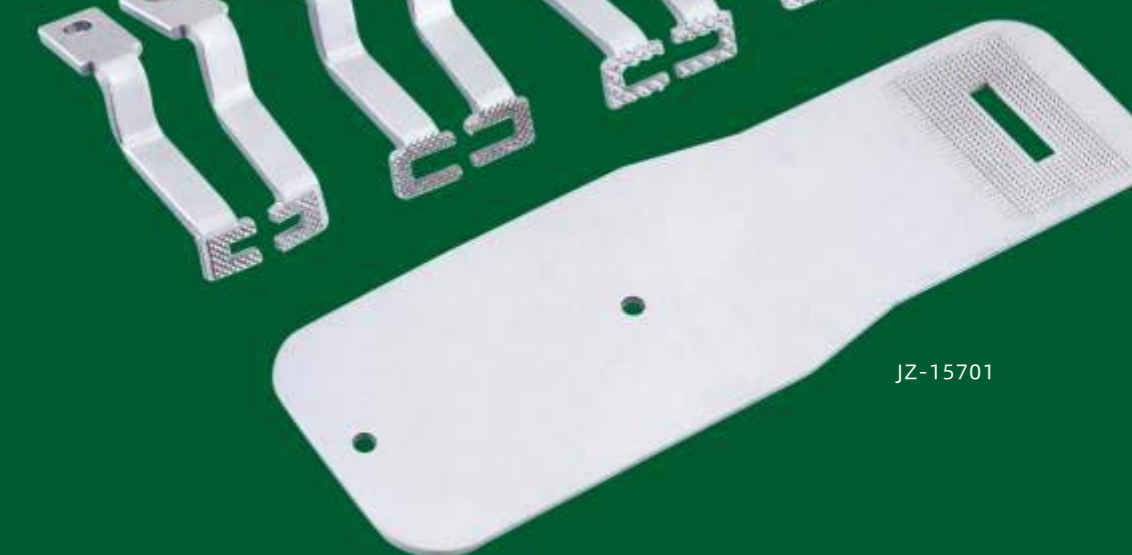

JZ-15701



**JUKI**



JZ-16101



JZ-16102



JZ-16103



JZ-16104



JZ-16105



JZ-16106



JZ-16107



JZ-16108



JZ-16109



JZ-16111



JZ-16112



JZ-16113



JZ-16114



JZ-16115



JZ-16116



JZ-16117



JZ-16118



JZ-16119



JZ-16120



JZ-16121



JZ-16122



JZ-16123



JZ-16124



JZ-16125



JZ-16126



JZ-16127



JZ-16128



JZ-16129



JZ-16130



JZ-16131



JZ-16132



JZ-16133



JZ-16134



JZ-16135



JZ-16136



JZ-16137



JZ-16138



JZ-16139



JZ-16140



JZ-16141



JZ-16142



JZ-16143



JZ-16144



JZ-16145



JZ-16146



JZ-16147



JZ-16148



JZ-16149



JZ-16150



JZ-16151



JZ-16152



JZ-16153

**brother**



JZ-16154



JZ-16155



JZ-16156



JZ-16157



JZ-16158



JZ-16159



JZ-16160



JZ-16161



JZ-16162



JZ-16163



JZ-16164



JZ-16165



JZ-16166



JZ-16167



JZ-16168



JZ-16169



JZ-16170



JZ-16171



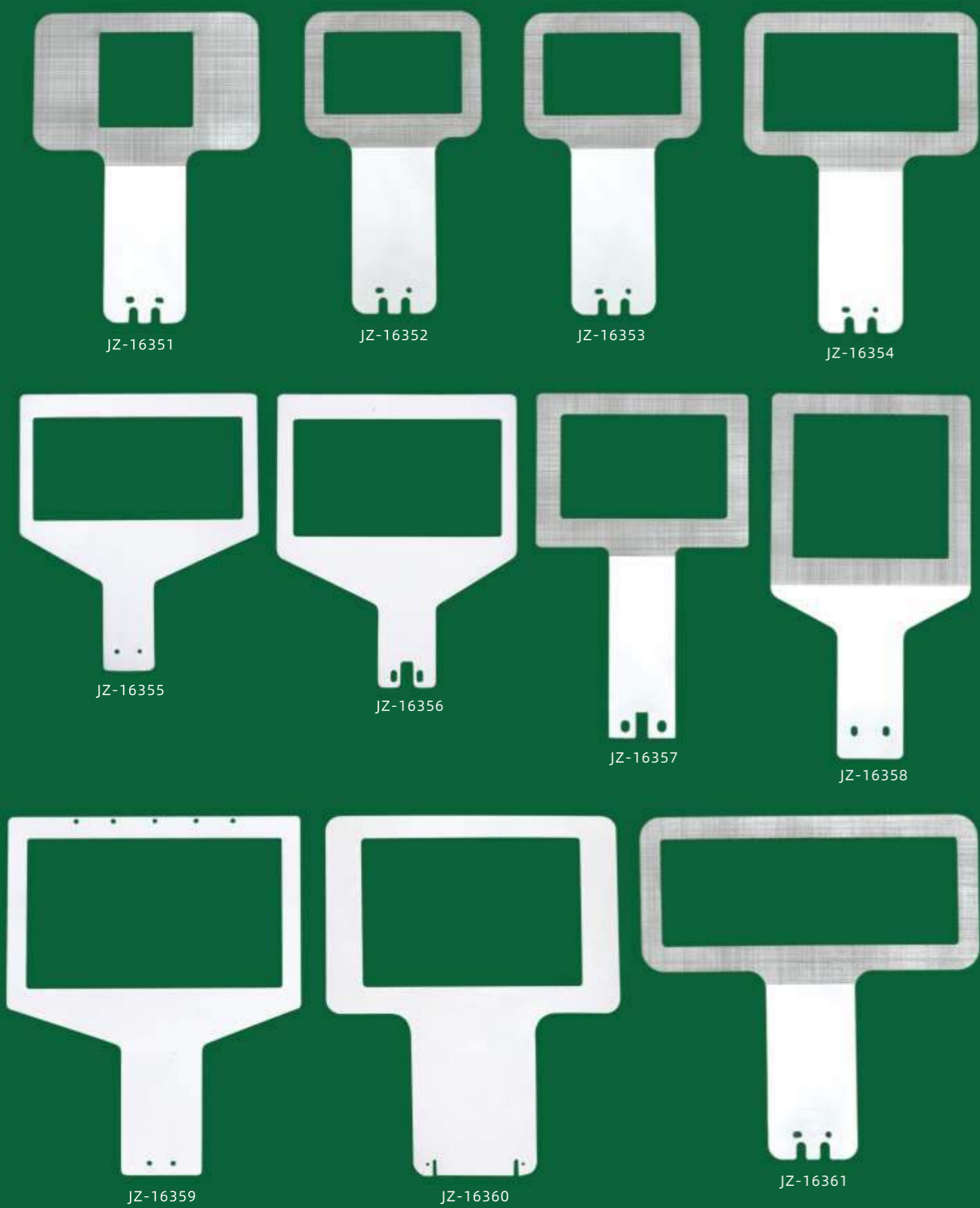

JZ-16351

JZ-16352

JZ-16353

JZ-16354

JZ-16355

JZ-16356

JZ-16357

JZ-16358

JZ-16359

JZ-16360

JZ-16361



JZ-16501 JUKI 5550 FOOT BAR

JZ-16502 铝合金针杆

JZ-16503 BROTHER 101

JZ-16504 5550 小孔针杆

JZ-16505 5550 大孔针杆

JZ-16506 JUKI 781

JZ-16507 JUKI 781

JZ-16508 JUKI 373

JZ-16509 JUKI 271

JZ-16510 SINGER 20U

JZ-16511 PEGASUS M600

JZ-16512 PEGASUS M700

JZ-16513 BROTHER 551

JZ-16514 BROTHER N31

JZ-16515 JUKI MO 3316

JZ-16516 GDS-1

JZ-16517 JUKI 515

JZ-16518 1182 FOOT BAR

JZ-16519 BROTHER 845

JZ-16520 JUKI 3168 FOOT BAR

JZ-16521 PF 335

JZ-16522 810

JZ-16523 820

JZ-16524 9910

JZ-16525 9920

JZ-16526 BROTHER 430

JZ-16527 JUKI 1850

JZ-16528 BROTHER 814

JZ-16529 311 平锁

JZ-16530 KASAI 1404

JZ-16531 YAMATO 2500

JZ-16532 PEGASUS W500

JZ-16533 PEGASUS W600

JZ-16534 SIRUBA F007

JZ-16535 SIRUBA C007

JZ-16536 EMBROIDERY

JZ-16537 JUKI 522

JZ-16538 GC 6-7

JZ-16539 JUKI 3168

JZ-16540 无油平车针杆 FREE OIL





**JINZEN**<sup>®</sup>

- BROTHER 430D JZ-16615
- JUKI 373 JZ-16616
- JUKI 1190 JZ-16617
- BROTHER 927 JZ-16618
- JUKI 1261 JZ-16619
- JUKI 6700 JZ-16620
- PEGASUS M700 JZ-16621
- PEGASUS M800 JZ-16622
- JZ-16601 JUKI MH380
- JZ-16602 JUKI 5550
- JZ-16603 JUKI 1900A
- JZ-16604 JUKI 1900A黑金刚
- JZ-16605 JUKI 1790
- JZ-16606 KASAI 2000C/1702
- JZ-16607 KASAI 1404
- JZ-16608 YAMATO VC2500
- JZ-16609 KASAI WX8800
- JZ-16610 PEGASUS W500
- JZ-16611 PEGASUS W600
- JZ-16612 JUKI MF7800
- JZ-16613 SIRUBA F007
- JZ-16614 KINGTEX CT6500













 JZ-17201 W600	 JZ-17202 C007	 JZ-17203 VC2700	 JZ-17204 Mo3600	 JZ-17205 B551
 JZ-17206 Ex3200	 JZ-17207 AZ60000	 JZ-17208 MO2500	 JZ-17209 MF7900	 JZ-17210 W500
 JZ-17211 M600	 JZ-17212 747	 JZ-17213 747	 JZ-17214 C31	 JZ-17215 VC2700
 JZ-17216 C007	 JZ-17217 VC2700	 JZ-17218 MF7700	 JZ-17219 SH7000	 JZ-17220 MO2500
 JZ-17221 Mo2500	 JZ-17222 AZ8000	 JZ-17223 AZ6000	 JZ-17224 M600	 JZ-17225 EX5100
 JZ-17226 C007/F007	 JZ-17227 MF7700	 JZ-17228 MO6900	 JZ-17229 F007	 JZ-17230 EX3200
 JZ-17231 Mf7700	 JZ-17232 VC2500	 JZ-17233 MO3600	 JZ-17234 7700	 JZ-17235 MO6900
 JZ-17236 W500	 JZ-17237 981	 JZ-17238 558	 JZ-17239 9820	 JZ-17240 3200



JINZEN®

# One-stop solution

缝配服务一站式采购

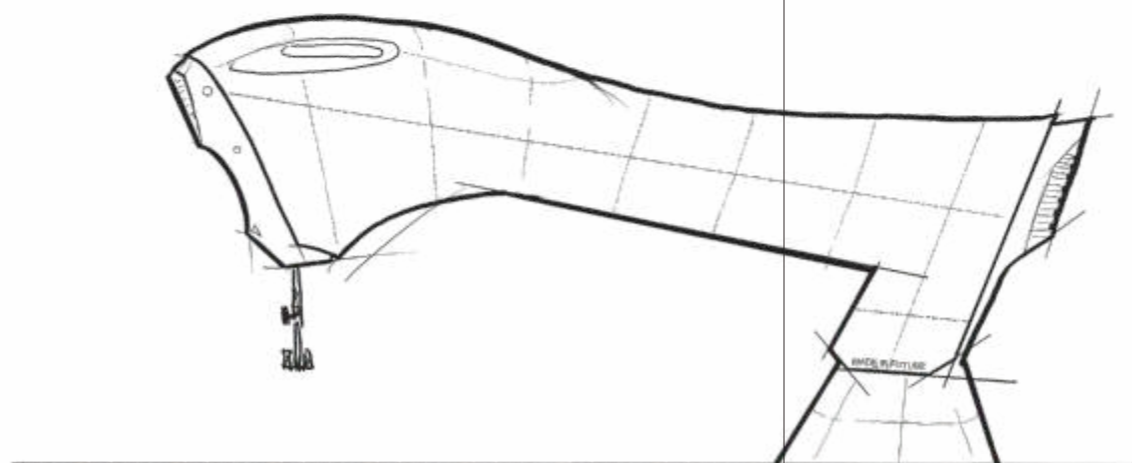
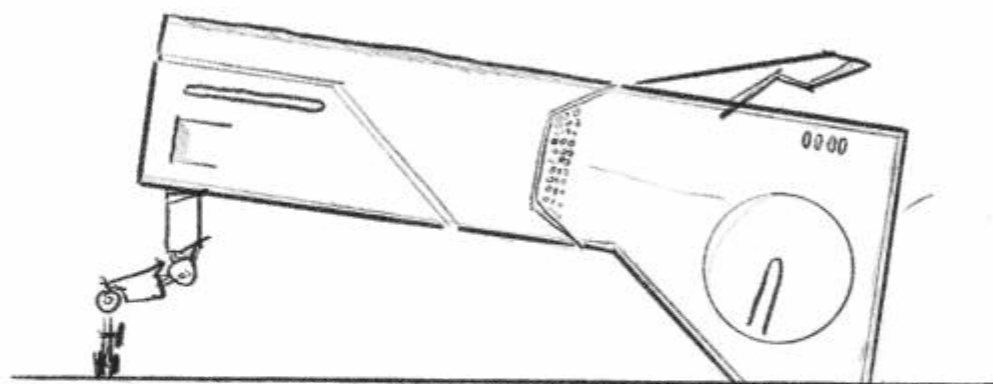
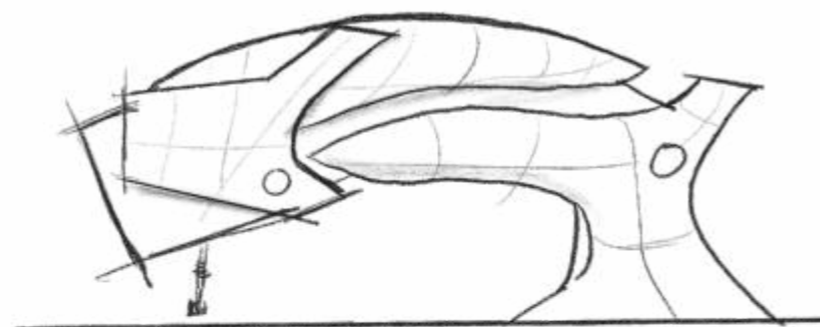

San Gar

各种整机内部配件  
SEWING MACHINE SPARE PARTS

TYPICAL

ZOJE

JACK

MAGIN

PFAFF

JINZEN

SIRUBA

SINGER

Kingtex

DÜRKOPP  
ADLER AG

SunStar

SHING LING

ZOX

kmsh

Eastman

KANSAI  
SPECIAL

Ijamato

PEGASUS

JUKI

NEWLONG

brother



**JUKI**  
重机 1850



JZ-20001



JZ-20002



JZ-20003



JZ-20004



JZ-20005



JZ-20052



JZ-20053



JZ-20054



JZ-20055



JZ-20057



JZ-20058



JZ-20059



JZ-20006



JZ-20007



JZ-20008



JZ-20009



JZ-20010



JZ-20011



JZ-20060



JZ-20061



JZ-20062



JZ-20063



JZ-20064



JZ-20065



JZ-20012



JZ-20013



JZ-20014



JZ-20015



JZ-20016



JZ-20017



JZ-20066



JZ-20067



JZ-20068



JZ-20069



JZ-20070



JZ-20071



JZ-20018



JZ-20019



JZ-20020



JZ-20021



JZ-20022



JZ-20023



JZ-20072



JZ-20073



JZ-20074



JZ-20075



JZ-20076



JZ-20077



JZ-20024



JZ-20025



JZ-20026



JZ-20027



JZ-20028



JZ-20029



JZ-20078



JZ-20079



JZ-20080



JZ-20081



JZ-20082



JZ-20083



JZ-20030



JZ-20031



JZ-20032



JZ-20033



JZ-20034



JZ-20035

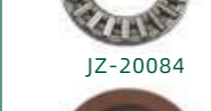

JZ-20084



JZ-20085



JZ-20086



JZ-20087

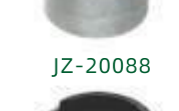

JZ-20088



JZ-20089



JZ-20036



JZ-20037



JZ-20038



JZ-20039



JZ-20040



JZ-20041



JZ-20090



JZ-20091



JZ-20092



JZ-20093



JZ-20094



JZ-20095



JZ-20042



JZ-20043



JZ-20044



JZ-20045



JZ-20046



JZ-20051



JZ-20096



JZ-20097



JZ-20098



JZ-20099



JZ-21000



JZ-21001



JZ-20047



JZ-20048



JZ-20049



JZ-20050



JZ-20102



JZ-20103



JZ-20104



JZ-20105



JZ-20106



JZ-20107



JZ-20108



JZ-20109



JZ-20110



JZ-20111



JZ-20112



JZ-20113



JZ-20114



JZ-20115



**JUKI**  
1900/1903



JZ-20198



JZ-20199 JZ-20200



JZ-20201 JZ-20202



JZ-20203



JZ-20204 JZ-20205



JZ-20206



JZ-20207



JZ-20208



JZ-20209



JZ-20210



JZ-20211



JZ-20212



JZ-20213



JZ-20214



JZ-20215



JZ-20216



JZ-20217



JZ-20218



JZ-20219



JZ-20220



JZ-20221



JZ-20222



JZ-20223



JZ-20224



JZ-20225



JZ-20226



JZ-20227



JZ-20228



JZ-20229



JZ-20230



JZ-20231



JZ-20232



JZ-20233



JZ-20234



JZ-20235



JZ-20236



JZ-20237



JZ-20238



JZ-20239



JZ-20240



JZ-20241



JZ-20242



JZ-20243



JZ-20244



JZ-20245



JZ-20246

JZ-20247



JZ-20248



JZ-20255



JZ-20261



JZ-20268



JZ-20274



JZ-20280



JZ-20286



JZ-20291

JZ-20249



JZ-20250



JZ-20256



JZ-20262



JZ-20269



JZ-20275



JZ-20281



JZ-20287



JZ-20292



JZ-20251



JZ-20257



JZ-20263



JZ-20270



JZ-20276



JZ-20282



JZ-20288



JZ-20293



JZ-20252



JZ-20258



JZ-20264



JZ-20271



JZ-20277



JZ-20283



JZ-20289



JZ-20294



JZ-20253



JZ-20259



JZ-20265



JZ-20272



JZ-20278



JZ-20284



JZ-20296



JZ-20297



JZ-20254



JZ-20260



JZ-20266



JZ-20267



JZ-20273



JZ-20279



JZ-20285



JZ-20290



JZ-20295



JZ-20297



**JUKI**  
**781**





JUKI  
781

 JZ-20454	 JZ-20455	 JZ-20456	 JZ-20457	 JZ-20458
 JZ-20459	 JZ-20460	 JZ-20461	 JZ-20462	 JZ-20463
 JZ-20464	 JZ-20465	 JZ-20466	 JZ-20467	 JZ-20468
 JZ-20469	 JZ-20470		 JZ-20471	
 JZ-20472	 JZ-20473	 JZ-20474	 JZ-20475	 JZ-20476
 JZ-20477	 JZ-20478	 JZ-20479	 JZ-20480	 JZ-20481
 JZ-20482	 JZ-20483	 JZ-20484	 JZ-20485	 JZ-20486
 JZ-20487	 JZ-20488	 JZ-20489	 JZ-20490	 JZ-20491
 JZ-20492	 JZ-20493	 JZ-20494	 JZ-20495	
 JZ-20496			 JZ-20497	
 JZ-20498		 JZ-20499		

JUKI  
373

 JZ-20551	 JZ-20552	 JZ-20553	 JZ-20554	 JZ-20555
 JZ-20556	 JZ-20557	 JZ-20558	 JZ-20559	 JZ-20560
 JZ-20561	 JZ-20562	 JZ-20563	 JZ-20564	 JZ-20565
 JZ-20566	 JZ-20567	 JZ-20568	 JZ-20569	 JZ-20570
 JZ-20571	 JZ-20572	 JZ-20573	 JZ-20574	 JZ-20575
 JZ-20576	 JZ-20577	 JZ-20578	 JZ-20579	 JZ-20580
 JZ-20581	 JZ-20582	 JZ-20583	 JZ-20584	 JZ-20585
 JZ-20586	 JZ-20587	 JZ-20588	 JZ-20589	 JZ-20590
 JZ-20591	 JZ-20592	 JZ-20593		
 JZ-20594			 JZ-20595	
 JZ-20596			 JZ-20597	
 JZ-20598			 JZ-20599	





JZ-20599



JZ-20600



JZ-20601



JZ-20602



JZ-20603



JZ-20646



JZ-20647



JZ-20648



JZ-20649



JZ-20650



JZ-20651



JZ-20604



JZ-20605



JZ-20606



JZ-20607



JZ-20608



JZ-20609



JZ-20652



JZ-20653



JZ-20654



JZ-20655



JZ-20656



JZ-20657



JZ-20610



JZ-20611



JZ-20612



JZ-20613



JZ-20614



JZ-20615



JZ-20658



JZ-20659



JZ-20660



JZ-20661



JZ-20662



JZ-20663



JZ-20616



JZ-20617



JZ-20618



JZ-20619



JZ-20620



JZ-20621



JZ-20664



JZ-20665



JZ-20666



JZ-20667



JZ-20668



JZ-20669



JZ-20622



JZ-20623



JZ-20624



JZ-20625



JZ-20626



JZ-20627



JZ-20670



JZ-20671



JZ-20672



JZ-20673



JZ-20674



JZ-20675 JZ-20676



JZ-20628



JZ-20694



JZ-20630



JZ-20631



JZ-20632



JZ-20633



JZ-20677



JZ-20678



JZ-20679



JZ-20680



JZ-20681



JZ-20682



JZ-20634



JZ-20635



JZ-20636



JZ-20637



JZ-20638



JZ-20639



JZ-20683



JZ-20684



JZ-20685

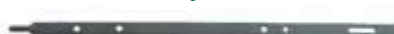

JZ-20686



JZ-20687



JZ-20688



JZ-20689



JZ-20690

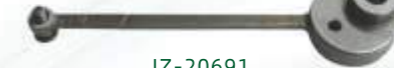

JZ-20691



JZ-20692



JZ-20693





**JUKI  
ddI9000**





细心、精心、用心，品质永保称心。

Carefully, carefully, carefully, the quality Yongbao Heart.

**JUKI**  
**380**



JZ-20901



JZ-20902



JZ-20903



JZ-20904



JZ-20905



JZ-20942



JZ-20943



JZ-20944



JZ-20945



JZ-20946



JZ-20947



JZ-20906



JZ-20907



JZ-20908



JZ-20909



JZ-20910



JZ-20911



JZ-20948



JZ-20949



JZ-20950



JZ-20951



JZ-20952



JZ-20953



JZ-20912



JZ-20913



JZ-20914



JZ-20915



JZ-20916



JZ-20917



JZ-20954



JZ-20955



JZ-20956



JZ-20957



JZ-20958



JZ-20959



JZ-20918



JZ-20919



JZ-20920



JZ-20921



JZ-20922



JZ-20923



JZ-20960



JZ-20961



JZ-20962



JZ-20963



JZ-20964



JZ-20965



JZ-20924



JZ-20925



JZ-20926



JZ-20927



JZ-20928



JZ-20929



JZ-20966



JZ-20967



JZ-20968



JZ-20969



JZ-20970



JZ-20971



JZ-20930



JZ-20931



JZ-20932



JZ-20933



JZ-20934



JZ-20935



JZ-20972



JZ-20973



JZ-20974



JZ-20975



JZ-20976



JZ-20977



JZ-20978



JZ-20979



JZ-20936



JZ-20937



JZ-20938



JZ-20939



JZ-20940



JZ-20941



JZ-20980



JZ-20981



JZ-20982



JZ-20983



**JUKI**  
1190 埋夹配件



JZ-21021      JZ-21022



JZ-21023      JZ-21024      JZ-21025



JZ-21026



JZ-21027      JZ-21028



JZ-21029      JZ-21030      JZ-21031



JZ-21032

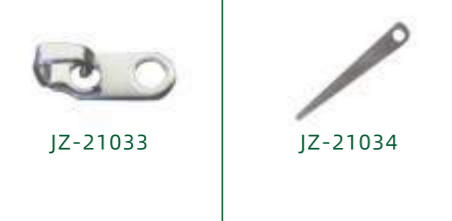

JZ-21033      JZ-21034



JZ-21035      JZ-21036      JZ-21037



JZ-21038



JZ-21039      JZ-21040



JZ-21041      JZ-21042      JZ-21043



JZ-21044



JZ-21045      JZ-21046



JZ-21047      JZ-21048      JZ-21049



JZ-21050



JZ-21051      JZ-21052



JZ-21053      JZ-21054      JZ-21055

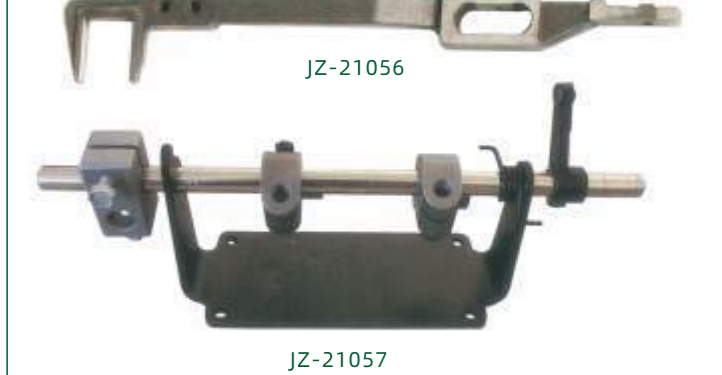

JZ-21056

JZ-21057

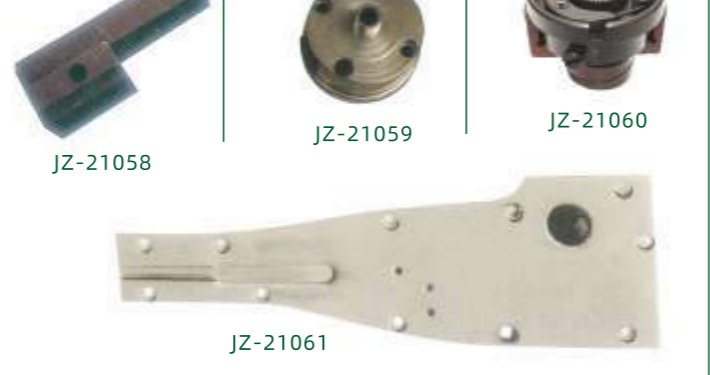

JZ-21058

JZ-21059

JZ-21060

JZ-21061



JZ-21062



JZ-21063      JZ-21064



JZ-21065      JZ-21066



JZ-21067



JZ-21068



JZ-21069      JZ-21070



JZ-21071      JZ-21072



JZ-21073



JZ-21074



JZ-21075      JZ-21076



JZ-21077      JZ-21078



JZ-21079



JZ-21080



JZ-21081      JZ-21082



JZ-21083      JZ-21084



JZ-21085



JZ-21086



JZ-21087      JZ-21088



JZ-21089      JZ-21090



JZ-21091



JZ-21092      JZ-21093

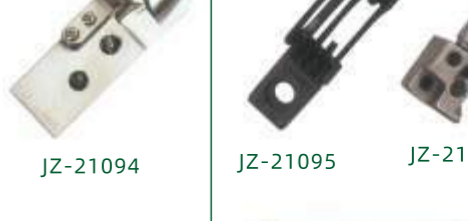

JZ-21094      JZ-21095



JZ-21096      JZ-21097



JZ-21098



JZ-21099      JZ-21100



JZ-21101      JZ-21106



JZ-21107      JZ-21108



JZ-21102



JZ-21103



**JUKI**  
2280











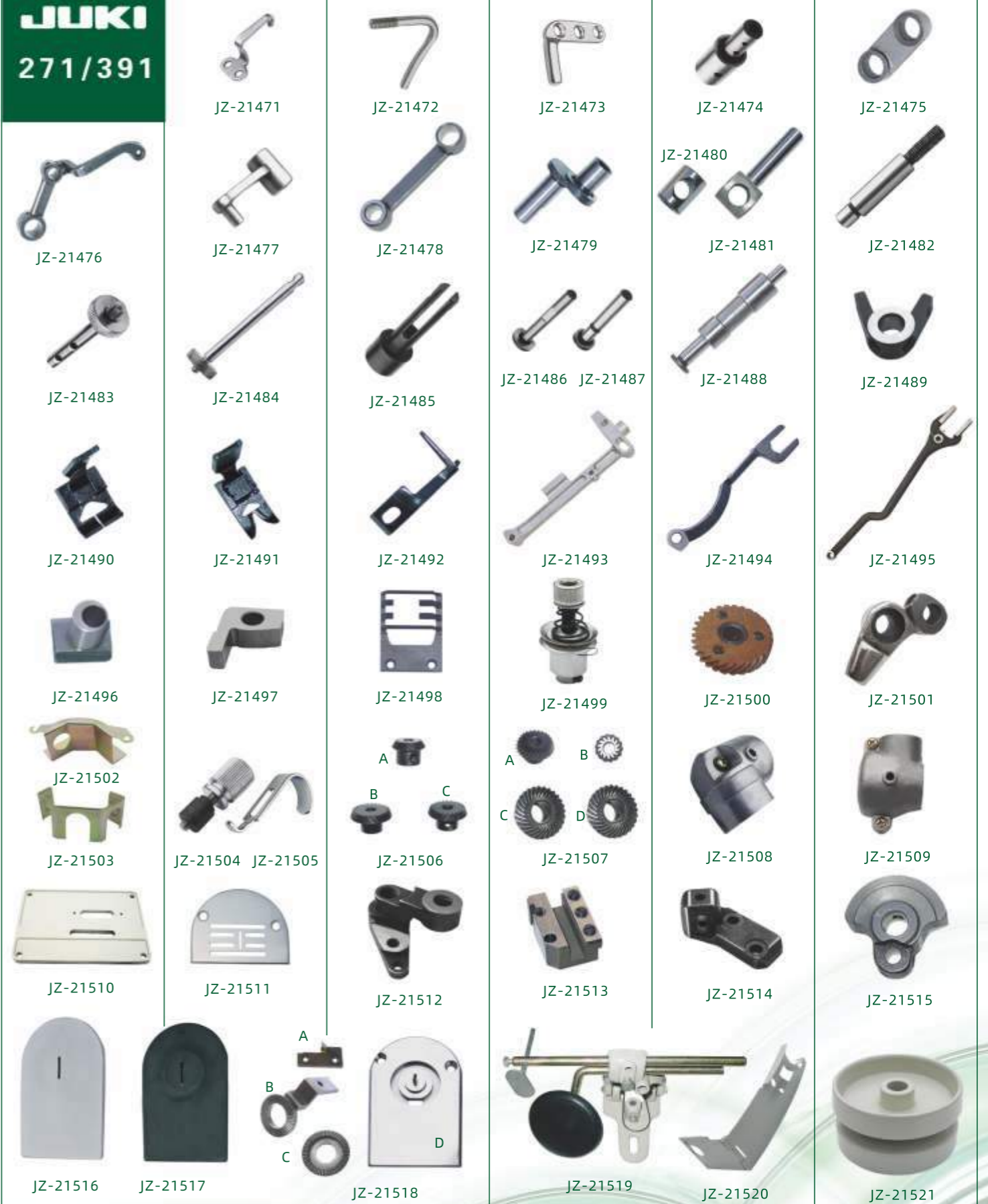



















































































**JUKI**  
**2280**



**JUKI**  
**271/391**





JUKI MO2516														
														
JZ-21576	JZ-21577	JZ-21578	JZ-21579	JZ-21580	JZ-21581	JZ-21632	JZ-21633	JZ-21634	JZ-21635	JZ-21636	JZ-21637			
														
JZ-21582	JZ-21583	JZ-21584	JZ-21585	JZ-21586	JZ-21587	JZ-21638	JZ-21639	JZ-21640	JZ-21641	JZ-21642	JZ-21643			
														
JZ-21588	JZ-21589	JZ-21590	JZ-21591	JZ-21592	JZ-21593	JZ-21644	JZ-21645	JZ-21646	JZ-21647	JZ-21648	JZ-21674			
														
JZ-21594 JZ-21596	JZ-21597	JZ-21598	JZ-21599	JZ-21600	JZ-21601	JZ-21650	JZ-21651	JZ-21652	JZ-21653	JZ-21654	JZ-21655			
														
JZ-21602	JZ-21603	JZ-21604	JZ-21605	JZ-21606	JZ-21607	JZ-21656	JZ-21657	JZ-21658	JZ-21659	JZ-21660	JZ-21661			
														
JZ-21608	JZ-21609	JZ-21610	JZ-21611	JZ-21612	JZ-21613	JZ-21662	JZ-21663	JZ-21664	JZ-21665	JZ-21666	JZ-21667			
														
JZ-21614	JZ-21615	JZ-21616	JZ-21617	JZ-21618	JZ-21619	JZ-21668	JZ-21669	JZ-21670	JZ-21671	JZ-21672	JZ-21673			
														
JZ-21620	JZ-21621	JZ-21622	JZ-21623	JZ-21624	JZ-21625									



**JUKI**  
**MO3600**

										
JZ-21721	JZ-21722	JZ-21723	JZ-21724	JZ-21725	JZ-21768	JZ-21769	JZ-21770	JZ-21771	JZ-21772	JZ-21773
										
JZ-21726	JZ-21727	JZ-21728	JZ-21729	JZ-21730	JZ-21731	JZ-21774	JZ-21775	JZ-21776	JZ-21777	JZ-21778
										
JZ-21732	JZ-21733	JZ-21734	JZ-21735	JZ-21736	JZ-21737	JZ-21780	JZ-21781	JZ-21782	JZ-21783	JZ-21784
										
JZ-21738	JZ-21739	JZ-21740	JZ-21741	JZ-21742	JZ-21743	JZ-21786	JZ-21787	JZ-21788	JZ-21789	JZ-21790
										
JZ-21744	JZ-21745	JZ-21746	JZ-21747	JZ-21748	JZ-21749 JZ-21815	JZ-21792	JZ-21793	JZ-21794	JZ-21795	JZ-21796
										
JZ-21750	JZ-21751	JZ-21752	JZ-21753	JZ-21754	JZ-21755	JZ-21798	JZ-21816	JZ-21799	JZ-21800	JZ-21801
										
JZ-21756	JZ-21757	JZ-21758	JZ-21759	JZ-21760	JZ-21761	JZ-21803	JZ-21804	JZ-21805	JZ-21806	JZ-21807
										
JZ-21762	JZ-21763	JZ-21764	JZ-21765	JZ-21766	JZ-21767	JZ-21809	JZ-21810	JZ-21811	JZ-21812	JZ-21813
										
						JZ-21814				



**JUKI**  
**MO3300**

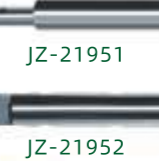
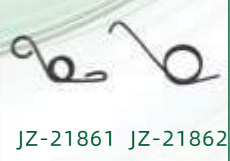



**JUKI**  
7700/7800



**JUKI**  
7700/7800



JZ-23592



JZ-23593



JZ-23594



JZ-23595



JZ-23596



JZ-23597



JZ-23598



JZ-23599



JZ-23600



JZ-23601



JZ-23602



JZ-23603



JZ-23604



JZ-23605



JZ-23606



JZ-23607



JZ-23608



JZ-23609



JZ-23610



JZ-23611



JZ-23612



JZ-23613



JZ-23614



JZ-23615



JZ-23616



JZ-23617



JZ-23618



JZ-23619



JZ-23620



JZ-23621



JZ-23622



JZ-23623



JZ-23624



JZ-23625



JZ-23626



JZ-23627



JZ-23628



JZ-23629



JZ-23630



JZ-23631



JZ-23632



JZ-23633



JZ-23634



JZ-23635



JZ-23636



JZ-23637



JZ-23638



JZ-23639



JZ-23640



JZ-23641



JZ-23642



JZ-23643



JZ-23644



JZ-23645



JZ-23646



JZ-23647



JZ-23648



JZ-23649



JZ-23650



JZ-23651



JZ-23652



JZ-23653



JZ-23654



JZ-23655



JZ-23656



JZ-23657



JZ-23658



JZ-23659



JZ-23660



JZ-23661



JZ-23663



JZ-23664



JZ-23665



JZ-23662



JZ-23666



**JUKI  
8700**



JZ-22011



JZ-22012



JZ-22013



JZ-22014



JZ-22015



JZ-22016



JZ-22017



JZ-22018



JZ-22019



JZ-22020



JZ-22021



JZ-22022



JZ-22023



JZ-22024



JZ-22025



JZ-22026



JZ-22027



JZ-22028



JZ-22029



JZ-22030



JZ-22031



JZ-22032



JZ-22033



JZ-22034



JZ-22035



JZ-22036



JZ-22037



JZ-22038



JZ-22039



JZ-22040



JZ-22041



JZ-22042-A



JZ-22043



JZ-22044



JZ-22045



JZ-22046



JZ-22047



JZ-22048



JZ-22049



JZ-22050



JZ-22051 JZ-22052

JZ-22053 JZ-22054



JZ-22055



JZ-22056



JZ-22057



JZ-22058



JZ-22059



JZ-22060



JZ-22061

JZ-22062

JZ-22063



JZ-22064



JZ-22065



JZ-22066



JZ-22067



JZ-22131 JZ-22132



JZ-22077



JZ-22088



JZ-22090

JZ-22095



JZ-22101



JZ-22108



JZ-22114



JZ-22122

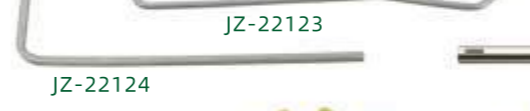

JZ-22123



JZ-22135



JZ-22136

JZ-22137



JZ-22133 JZ-22134



JZ-22081 JZ-22082



JZ-22089



JZ-22096



JZ-22102



JZ-22109



JZ-22115



JZ-22116



JZ-22068 JZ-22069



JZ-22083 JZ-22084



JZ-22091



JZ-22097



JZ-22103



JZ-22110



JZ-22117



JZ-22143



JZ-22070 JZ-22071



JZ-22085



JZ-22092



JZ-22098



JZ-22104 JZ-22105



JZ-22111



JZ-22115



JZ-22141



JZ-22144



JZ-22074



JZ-22086



JZ-22093



JZ-22099



JZ-22106



JZ-22112



JZ-22119



JZ-22128



JZ-22129



JZ-22140



JZ-22142



JZ-22075 JZ-22076



JZ-22087



JZ-22094



JZ-22100



JZ-22107



JZ-22113



JZ-22121



JZ-22128



JZ-22129



JZ-22142



**JUKI**  
522



**JUKI**  
重机 3168





**JUKI**  
重机双针 515



JZ-22401 JZ-22402 JZ-22403 JZ-22404  
 JZ-22405 JZ-22406 JZ-22407 JZ-22408 JZ-22409  
 JZ-22410 JZ-22411 JZ-22412 JZ-22413 JZ-22414  
 JZ-22415 JZ-22416 JZ-22417 JZ-22418 JZ-22419  
 JZ-22420 JZ-22421 JZ-22422 JZ-22423 JZ-22424  
 JZ-22425 JZ-22426 JZ-22427 JZ-22428 JZ-22429  
 JZ-22430 JZ-22431 JZ-22432 JZ-22433 JZ-22434  
 JZ-22435 JZ-22436 JZ-22437 JZ-22438  
 JZ-22439 JZ-22440 JZ-22441 JZ-22442 JZ-22443  
 JZ-22444 JZ-22445 JZ-22446  
 JZ-22447 JZ-22448 JZ-22449 JZ-22450 JZ-22451  
 JZ-22452 JZ-22453 JZ-22454

**JUKI**  
1790



JZ-22563 JZ-22564 JZ-22565 JZ-22566 JZ-22567  
 JZ-22568 JZ-22569 JZ-22570 JZ-22571 JZ-22572 JZ-22573  
 JZ-22574 JZ-22575 JZ-22576 JZ-22577  
 JZ-22578  
 JZ-22579 JZ-22580 JZ-22581  
 JZ-22582  
 JZ-22583  
 JZ-22584  
 JZ-22585 1790 SET  
 JZ-22586 29珠  
 JZ-22587 25珠  
 JZ-22588 18珠  
 JZ-22589 7珠  
 JZ-22590 6珠  
 JZ-22591 5珠  
 B2513-215-000  
 JZ-22592 JZ-22593 JZ-22594  
 JZ-22595 5珠  
 JZ-22596 6珠  
 JZ-22597 15珠  
 JZ-22598 19珠  
 JZ-22599 23珠  
 JZ-22600 31珠



JUKI

重机 1790



JZ-22601 JZ-22602



JZ-22603



JZ-22604 JZ-22605



JZ-22606



JZ-22607



JZ-22608 JZ-22609



JZ-22610



JZ-22611



JZ-22612



JZ-22613



JZ-22614



JZ-22615



JZ-22616



JZ-22617



JZ-22618



JZ-22619



JZ-22620



JZ-22621



JZ-22622



JZ-22623



JZ-22624



JZ-22625



JZ-22626



JZ-22627



JZ-22628



JZ-22629



JZ-22630



JZ-22631



JZ-22632



JZ-22633



JZ-22634



JZ-22635



JZ-22636



JZ-22637



JZ-22638



JZ-22639



JZ-22640



JZ-22641



JZ-22642



JZ-22643



JZ-22644



JZ-22645



JZ-22646



JZ-22647



JZ-22648



JZ-22649



JZ-22650



JZ-22651



JZ-22652



JZ-22653



JZ-22654



JZ-22655



JZ-22656



JZ-22657



JZ-22658



JZ-22659



JZ-22660



JZ-22661



JZ-22662



JZ-22663



JZ-22664



JZ-22665



JZ-22666



JZ-22667



JZ-22668



JZ-22669



JZ-22670



JZ-22671



JZ-22672



JZ-22673



JZ-22674



JZ-22675



JZ-22676



JZ-22677



JZ-22678



JZ-22679



JZ-22680



JZ-22681



JZ-22682



JZ-22683



JZ-22684



JZ-22685



JZ-22686



JZ-22687



JZ-22688



JZ-22689

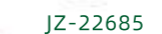

JZ-22690



JZ-22691



JZ-22692



JZ-22693



JZ-22694



JZ-22695

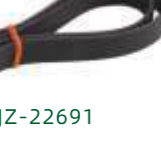

JZ-22696



JZ-22697



**JUKI**  
重机 210D

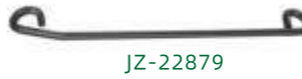
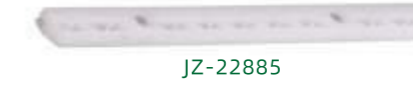
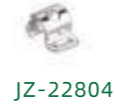
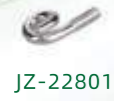



**brother**  
电脑平车 101/735

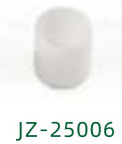



**brother  
7200**





brother  
430



JZ-25301



JZ-25302



JZ-25303



JZ-25304



JZ-25305



JZ-25347



JZ-25348



JZ-25349



JZ-25350



JZ-25351



JZ-25352



JZ-25306



JZ-25307



JZ-25308



JZ-25309



JZ-25310



JZ-25311



JZ-25353



JZ-25354



JZ-25355



JZ-25356



JZ-25357



JZ-25358



JZ-25312



JZ-25313



JZ-25314



JZ-25315



JZ-25316



JZ-25317



JZ-25359



JZ-25360



JZ-25361



JZ-25362



JZ-25363



JZ-25364



JZ-25318



JZ-25319



JZ-25320



JZ-25321



JZ-25322



JZ-25323



JZ-25365



JZ-25366



JZ-25367



JZ-25368



JZ-25369



JZ-25370



JZ-25324



JZ-25325



JZ-25326



JZ-25327



JZ-25328



JZ-25329



JZ-25371



JZ-25372



JZ-25373



JZ-25374



JZ-25375



JZ-25376

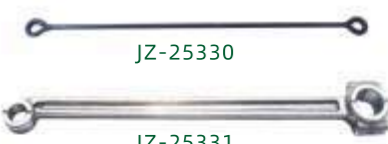

JZ-25330

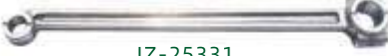

JZ-25331



JZ-25332



JZ-25333



JZ-25334



JZ-25335



JZ-25377



JZ-25378



JZ-25379



JZ-25380



JZ-25381



JZ-25382



JZ-25336



JZ-25337



JZ-25338



JZ-25339



JZ-25342



JZ-25343



JZ-25344



JZ-25345



JZ-25346



JZ-25383



JZ-25384



JZ-25385



JZ-25386



JZ-25387



JZ-25388



JZ-25340



JZ-25341



JZ-25389



JZ-25390



JZ-25391



JZ-25392



brother  
430D



JZ-25442



JZ-25443



JZ-25444



JZ-25445



JZ-25446



JZ-25447



JZ-25448



JZ-25449



JZ-25450



JZ-25451



JZ-25452



JZ-25453



JZ-25454



JZ-25455



JZ-25456



JZ-25457



JZ-25458



JZ-25459



JZ-25460



JZ-25461



JZ-25462



JZ-25463



JZ-25464



JZ-25465



JZ-25466



JZ-25467



JZ-25468



JZ-25469



JZ-25470

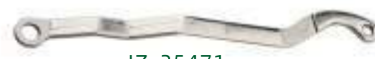

JZ-25471



JZ-25477



JZ-25472



JZ-25473



JZ-25474



JZ-25475



JZ-25476



JZ-25478



JZ-25479



JZ-25480



JZ-25481

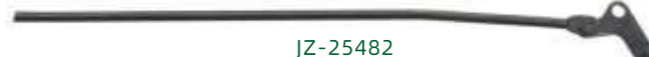

JZ-25482



JZ-25483



JZ-25484



JZ-25485



JZ-25486



JZ-25487



JZ-25488



JZ-25489



JZ-25490



JZ-25491



JZ-25492



JZ-25493



JZ-25494



JZ-25495



JZ-25496



JZ-25497



JZ-25498



JZ-25499



JZ-25500



JZ-25501



JZ-25502



JZ-25503



JZ-25504



JZ-25505



JZ-25506



JZ-25507



JZ-25508



JZ-25509



JZ-25510



JZ-25511



JZ-23512



JZ-25513



JZ-25514



JZ-25515



JZ-25516



JZ-25517



JZ-25518



JZ-25519



JZ-25520



JZ-25521



JZ-25522



JZ-25523



JZ-25524



JZ-25525



## brother 814

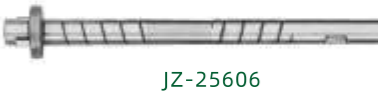

JZ-25652





**brother**  
**814**

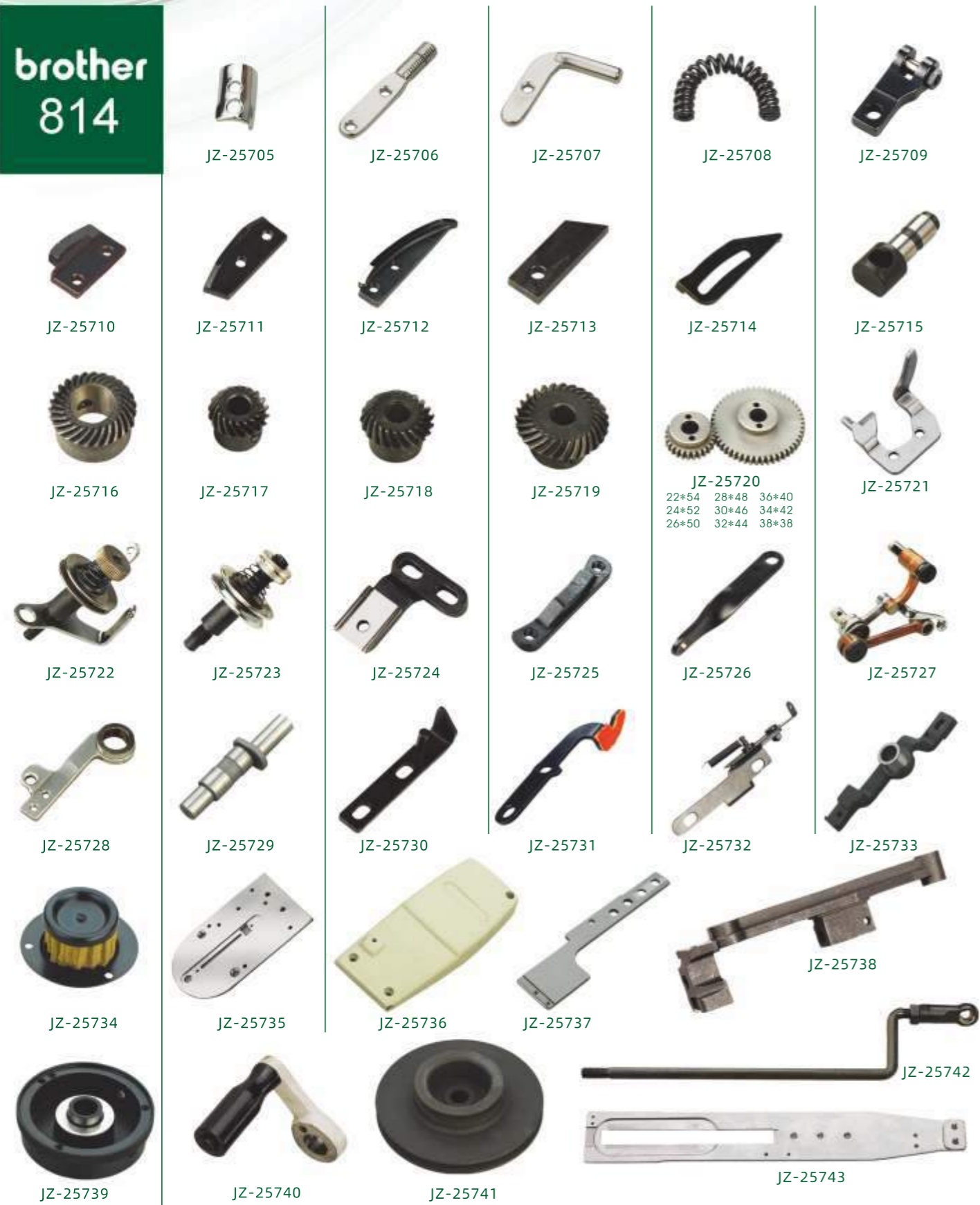

**brother**  
 兄弟双针 845





brother  
兄弟 917



JZ-25892



JZ-25893



JZ-25894



JZ-25895



JZ-25896



JZ-25937



JZ-25938



JZ-25939



JZ-25940



JZ-25941



JZ-25942



JZ-25897



JZ-25898



JZ-25899



JZ-25900



JZ-25901



JZ-25902



JZ-25903



JZ-25904



JZ-25905



JZ-25906



JZ-25907



JZ-25908



JZ-25943



JZ-25944



JZ-25945



JZ-25946



JZ-25947



JZ-25948



JZ-25909



JZ-25910



JZ-25911



JZ-25912



JZ-25913



JZ-25914



JZ-25949



JZ-25950



JZ-25951



JZ-25952



JZ-25953



JZ-25954



JZ-25915



JZ-25916



JZ-25917



JZ-25918



JZ-25919



JZ-25920



JZ-25955



JZ-25956



JZ-25957



JZ-25958



JZ-25959



JZ-25960



JZ-25921



JZ-25922



JZ-25923



JZ-25924



JZ-25925



JZ-25926



JZ-25961



JZ-25962



JZ-25963



JZ-25964



JZ-25965



JZ-25966



JZ-25927



JZ-25928



JZ-25929



JZ-25930



JZ-25931



JZ-25932



JZ-25967



JZ-25968



JZ-25969



JZ-25970



JZ-25971



JZ-25972



JZ-25973

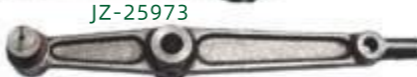

JZ-25974



JZ-25975



JZ-25976



JZ-25977



JZ-25978



JZ-25933



JZ-25934



JZ-25935



JZ-25936



JZ-25979



JZ-25980



JZ-25981



JZ-25982



JZ-25983



**brother  
927、928**

 JZ-26051	 JZ-26052	 JZ-26053	 JZ-26054	 JZ-26055	 JZ-26106	 JZ-26107	 JZ-26108	 JZ-26109	 JZ-26110	 JZ-26111				
 JZ-26056	 JZ-26057	 JZ-26058	 JZ-26059	 JZ-26060	 JZ-26061	 JZ-26062	 JZ-26063	 JZ-26064	 JZ-26112	 JZ-26113	 JZ-26114	 JZ-26115	 JZ-26116	 JZ-26117
 JZ-26065	 JZ-26066	 JZ-26067	 JZ-26068	 JZ-26069	 JZ-26070	 JZ-26118	 JZ-26119	 JZ-26120	 JZ-26121	 JZ-26122	 JZ-26123			
 JZ-26071	 JZ-26072	 JZ-26073	 JZ-26074	 JZ-26075	 JZ-26076	 JZ-26124	 JZ-26125	 JZ-26126	 JZ-26127	 JZ-26128	 JZ-26129			
 JZ-26077	 JZ-26078	 JZ-26079	 JZ-26080	 JZ-26081	 JZ-26082	 JZ-26083	 JZ-26084	 JZ-26085	 JZ-26130	 JZ-26131	 JZ-26132	 JZ-26133	 JZ-26134	 JZ-26135
 JZ-26086	 JZ-26087	 JZ-26088	 JZ-26089	 JZ-26090	 JZ-26091	 JZ-26136	 JZ-26137	 JZ-26138	 JZ-26139	 JZ-26140	 JZ-26141	 JZ-26142		
 JZ-26092	 JZ-26093	 JZ-26094	 JZ-26095	 JZ-26096	 JZ-26097	 JZ-26098	 JZ-26099	 JZ-26100	 JZ-26101	 JZ-26102	 JZ-26103	 JZ-26104	 JZ-26105	
 JZ-26143	 JZ-26144	 JZ-26145	 JZ-26146	 JZ-26147	 JZ-26148	 JZ-26149	 JZ-26150	 JZ-26151	 JZ-26152					



brother  
9810  
9820



JZ-26211



JZ-26212



JZ-26213



JZ-26214



JZ-26215



JZ-26216



JZ-26217



JZ-26218



JZ-26219



JZ-26220



JZ-26221



JZ-26222



JZ-26223



JZ-26224



JZ-26225



JZ-26226



JZ-26227



JZ-26228



JZ-26229



JZ-26230



JZ-26231



JZ-26232



JZ-26233



JZ-26234



JZ-26235



JZ-26236



JZ-26237



JZ-26238



JZ-26239



JZ-26240



JZ-26241



JZ-26242



JZ-26243



JZ-26244



JZ-26245



JZ-26246



JZ-26247



JZ-26248



JZ-26249



JZ-26250



JZ-26251



JZ-26252



JZ-26253



JZ-26254



JZ-26255



JZ-26256



JZ-26257



JZ-26258



JZ-26259



JZ-26260



JZ-26261



JZ-26262



JZ-26263



JZ-26264



JZ-26265



JZ-26266



JZ-26267



JZ-26268



JZ-26269



JZ-26270



JZ-26271



JZ-26272



JZ-26273



JZ-26274



JZ-26275



JZ-26276



JZ-26277



JZ-26278



JZ-26279



JZ-26280



JZ-26281



JZ-26282



JZ-26283



JZ-26284



JZ-26285



JZ-26286



JZ-26287



JZ-26288



JZ-26289



JZ-26290

JZ-26291



brother  
9810  
9820



JZ-26292



JZ-26293



JZ-26294



JZ-26295



JZ-26296



JZ-26338

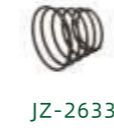

JZ-26339



JZ-26340



JZ-26341



JZ-26342



JZ-26343



JZ-26297



JZ-26298



JZ-26299



JZ-26300



JZ-26301



JZ-26302



JZ-26344



JZ-26345



JZ-26346



JZ-26347



JZ-26348



JZ-26349



JZ-26303



JZ-26304



JZ-26305



JZ-26306



JZ-26307



JZ-26308



JZ-26350



JZ-26351



JZ-26352



JZ-26353



JZ-26354



JZ-26355



JZ-26309



JZ-26310



JZ-26311



JZ-26312



JZ-26313



JZ-26314



JZ-26356



JZ-26357



JZ-26358



JZ-26359



JZ-26360



JZ-26361



JZ-26315



JZ-26316



JZ-26317



JZ-26318



JZ-26319



JZ-26320



JZ-26362



JZ-26363



JZ-26364



JZ-26365



JZ-26366



JZ-26321



JZ-26322



JZ-26323



JZ-26324



JZ-26325



JZ-26326



JZ-26367



JZ-26368

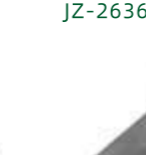

JZ-26369



JZ-26370



JZ-26371

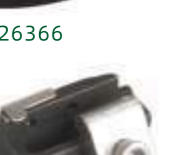

JZ-26372



JZ-26327



JZ-26328



JZ-26329



JZ-26330



JZ-26331



JZ-26332



JZ-26375



JZ-26376



JZ-26377



JZ-26378



JZ-26379



JZ-26374



JZ-26333



JZ-26334



JZ-26335



JZ-26336



JZ-26337



JZ-26370



JZ-26371

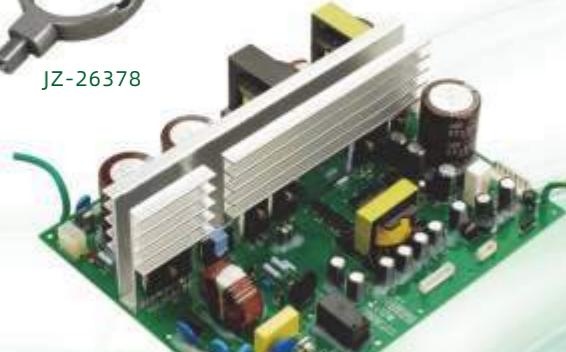

JZ-26372



## brother 531、551

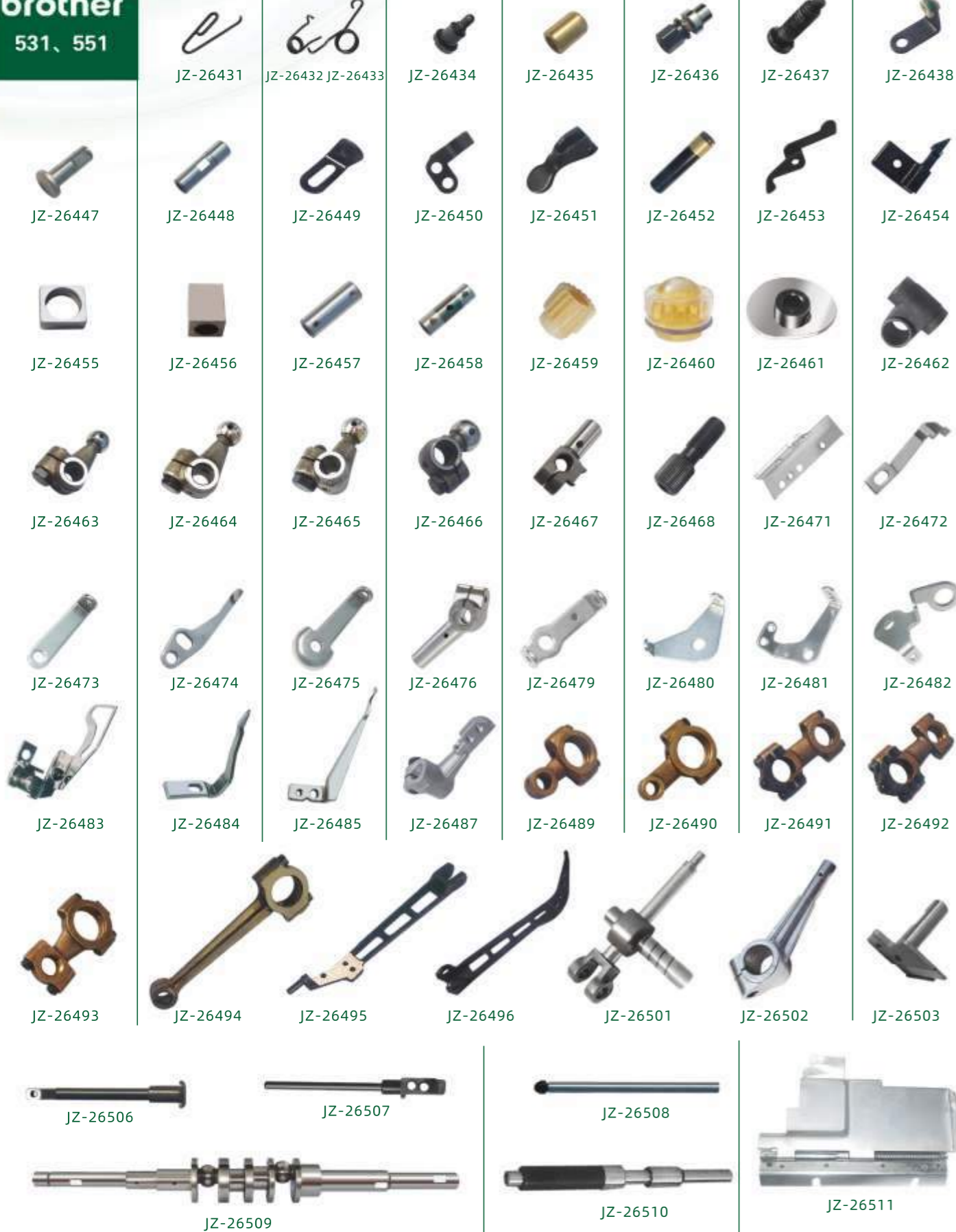

## brother 兄弟 N31

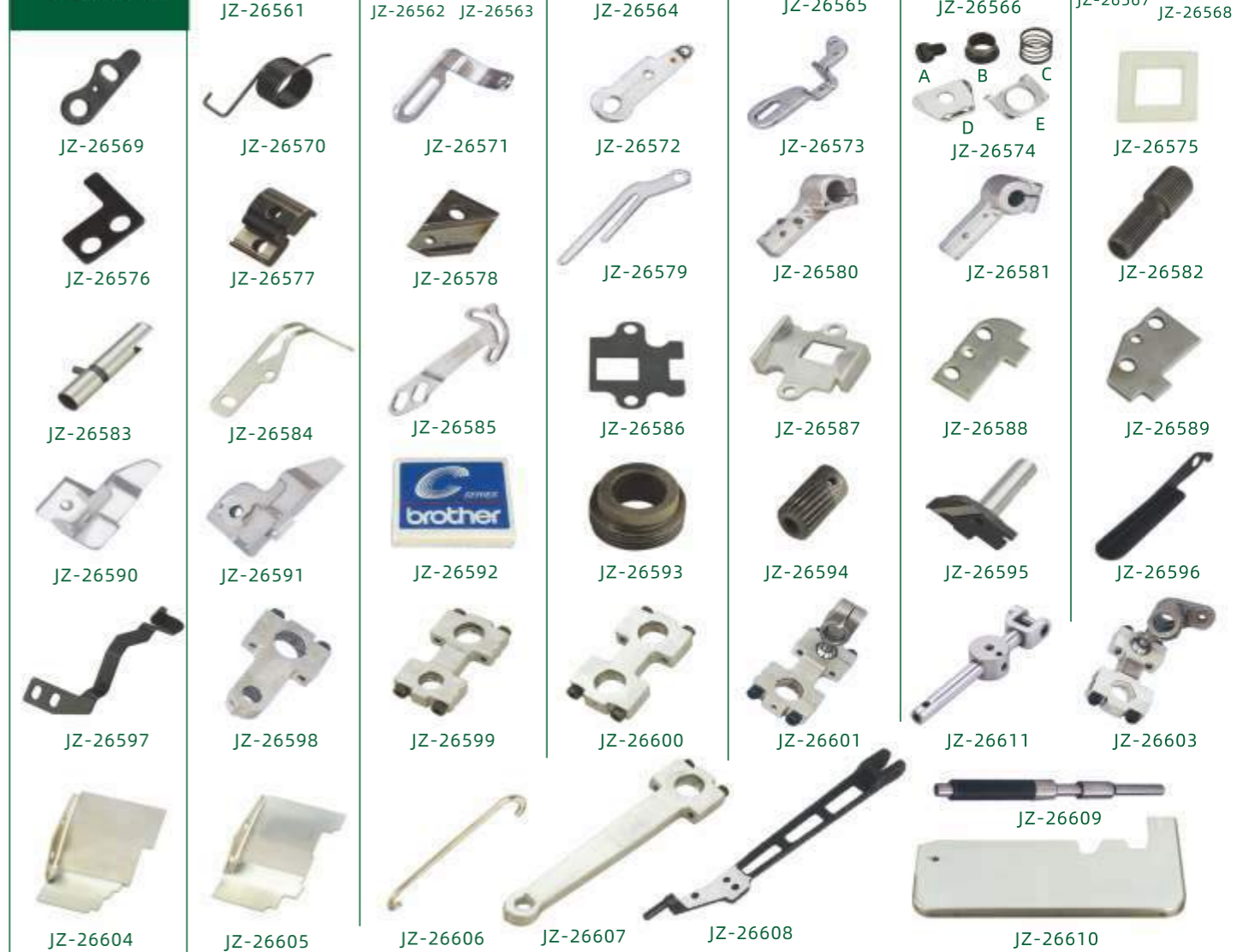

## brother HE800A





PEGASUS  
M800



JZ-29801



JZ-29802



JZ-29803



JZ-29804



JZ-29805



JZ-29806



JZ-29807



JZ-29808



JZ-29809



JZ-29810



JZ-29811



JZ-29812



JZ-29813



JZ-29814



JZ-29815



JZ-29816



JZ-29817



JZ-29818



JZ-29819



JZ-29820



JZ-29821



JZ-29822



JZ-29823



JZ-29824



JZ-29825



JZ-29826



JZ-29827



JZ-29828



JZ-29829



JZ-29830



JZ-29831



JZ-29832



JZ-29833



JZ-29834



JZ-29835



JZ-29836



JZ-29837



JZ-29838



JZ-29839



JZ-29840



JZ-29841



JZ-29842



JZ-29843



JZ-29844



JZ-29845

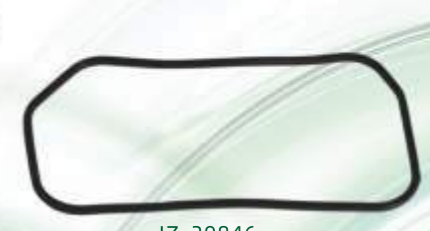





























































































JZ-29846

JINZEN®

有一种经营叫规模  
上万个缝纫零部件及附件  
为全球客户的长久服务...  
一起成就着金振的规模产业!



**PEGASUS  
M600**

											
JZ-30001	JZ-30002	JZ-30003 JZ-30004	JZ-30005	JZ-30006		JZ-30048	JZ-30049	JZ-30050	JZ-30051	JZ-30052	JZ-30053
											
JZ-30007	JZ-30008	JZ-30009	JZ-30010	JZ-30011	JZ-30012	JZ-30054	JZ-30055	JZ-30056	JZ-30057	JZ-30058	JZ-30059
											
JZ-30013	JZ-30014	JZ-30015	JZ-30016	JZ-30017	JZ-30018	JZ-30060	JZ-30061	JZ-30062	JZ-30063	JZ-30064	JZ-30065
											
JZ-30019	JZ-30020	JZ-30021	JZ-30022	JZ-30023	JZ-30024	JZ-30066	JZ-30067	JZ-30068	JZ-30069	JZ-30070	JZ-30071
											
JZ-30025	JZ-30026	JZ-30027	JZ-30028	JZ-30029	JZ-30030	JZ-30072	JZ-30073	JZ-30074	JZ-30075	JZ-30076	JZ-30077
											
JZ-30031	JZ-30032	JZ-30033	JZ-30034	JZ-30035	JZ-30036	JZ-30078	JZ-30079	JZ-30080	JZ-30081	JZ-30082	JZ-30083
											
JZ-30037	JZ-30038	JZ-30039	JZ-30040	JZ-30041	JZ-30042	JZ-30084	JZ-30085	JZ-30086	JZ-30087	JZ-30091	
											
JZ-30043	JZ-30044	JZ-30045		JZ-30046	JZ-30047	JZ-30088	JZ-30089	JZ-30090		JZ-30092	
											
										JZ-30093	



### PEGASUS M700



JZ-30151



JZ-30152



JZ-30153



JZ-30154



JZ-30155



JZ-30156



JZ-30157



JZ-30158



JZ-30159



JZ-30160



JZ-30161



JZ-30196



JZ-30197



JZ-30198



JZ-30199



JZ-30200



JZ-30201



JZ-30162



JZ-30163



JZ-30164



JZ-30165



JZ-30166



JZ-30202



JZ-30203



JZ-30204



JZ-30205



JZ-30206



JZ-30207



JZ-30168



JZ-30169



JZ-30170



JZ-30171



JZ-30172



JZ-30208



JZ-30209



JZ-30210



JZ-30211



JZ-30212



JZ-30213



JZ-30174



JZ-30175



JZ-30176



JZ-30177



JZ-30178



JZ-30179



JZ-30214



JZ-30215



JZ-30216



JZ-30217



JZ-30218



JZ-30219



JZ-30180



JZ-30181



JZ-30182



JZ-30183



JZ-30184



JZ-30185



JZ-30220



JZ-30221



JZ-30222



JZ-30223



JZ-30224



JZ-30225



JZ-30186



JZ-30187



JZ-30188



JZ-30189



JZ-30190



JZ-30191



JZ-30226



JZ-30227



JZ-30228



JZ-30229



JZ-30230



JZ-30231



JZ-30192



JZ-30193



JZ-30195



JZ-30243



JZ-30232



JZ-30233



JZ-30234



JZ-30235



JZ-30236



JZ-30237



JZ-30239



JZ-30240



JZ-30241



JZ-30242



**PEGASUS  
W500**



JZ-30290



JZ-30291



JZ-30292



JZ-30293



JZ-30294



JZ-30295



JZ-30296



JZ-30297



JZ-30298



JZ-30299



JZ-30300



JZ-30301



JZ-30302



JZ-30303



JZ-30304



JZ-30305



JZ-30306



JZ-30307



JZ-30308



JZ-30309



JZ-30310 JZ-30311



JZ-30312



JZ-30313



JZ-30314



JZ-30315



JZ-30316



JZ-30317



JZ-30318



JZ-30319



JZ-30320



JZ-30321



JZ-30322



JZ-30323



JZ-30324



JZ-30325



JZ-30326



JZ-30327



JZ-30328



JZ-30329



JZ-30330



JZ-30331



JZ-30332



JZ-30333



JZ-30334



JZ-30335



JZ-30336



JZ-30337



JZ-30338



JZ-30339



JZ-30340



JZ-30341



JZ-30342



JZ-30343



JZ-30344



JZ-30345



JZ-30346



JZ-30347



JZ-30348



JZ-30349



JZ-30350



JZ-30351



JZ-30352



JZ-30353



JZ-30354



JZ-30355



JZ-30356



JZ-30357



JZ-30358



JZ-30359



JZ-30360



JZ-30361



JZ-30362



JZ-30363



JZ-30364



JZ-30365



JZ-30366



JZ-30367



JZ-30368



JZ-30369



JZ-30370



JZ-30371



JZ-30372



JZ-30373



JZ-30374



JZ-30375



JZ-30376



JZ-30377



JZ-30378



JZ-30379



JZ-30380



JZ-30381



JZ-30382



JZ-30383



JZ-30384



JZ-30385



JZ-30386



JZ-30387



JZ-30388



JZ-30389



JZ-30390

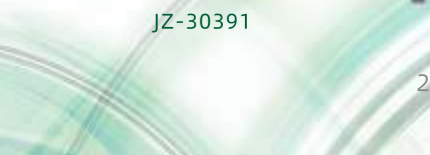

JZ-30391



**PEGASUS  
W664**



JZ-30441



JZ-30442



JZ-30443



JZ-30444



JZ-30445



JZ-30485



JZ-30486



JZ-30487



JZ-30488



JZ-30489



JZ-30490



JZ-30446



JZ-30447



JZ-30448



JZ-30449



JZ-30450



JZ-30451



JZ-30491



JZ-30492



JZ-30493



JZ-30494



JZ-30495



JZ-30496



JZ-30452



JZ-30453



JZ-30454



JZ-30455



JZ-30456



JZ-30457



JZ-30497



JZ-30498



JZ-30499



JZ-30500



JZ-30501



JZ-30502



JZ-30458



JZ-30459



JZ-30460



JZ-30461



JZ-30462



JZ-30463



JZ-30503



JZ-30504



JZ-30505



JZ-30506



JZ-30507



JZ-30508



JZ-30464



JZ-30465



JZ-30466



JZ-30467



JZ-30468



JZ-30469



JZ-30509



JZ-30510



JZ-30511



JZ-30512



JZ-30513



JZ-30514



JZ-30470



JZ-30471



JZ-30472



JZ-30473



JZ-30474



JZ-30475



JZ-30515



JZ-30516



JZ-30517



JZ-30518



JZ-30519



JZ-30520



JZ-30476



JZ-30478

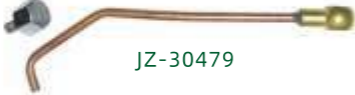

JZ-30479



JZ-30481



JZ-30482



JZ-30483



JZ-30484



JZ-30521

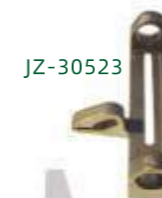

JZ-30523



JZ-30522



JZ-30524



JZ-30525



JZ-30526



JZ-30527



JZ-30528

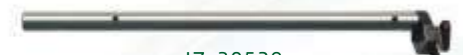

JZ-30529



JZ-30530



JZ-30531



**PEGASUS**  
EX3200  
EX5100  
MX3200



JZ-30587

JZ-30588

JZ-30589

JZ-30590

JZ-30591

JZ-30592



JZ-30593

JZ-30594

JZ-30595

JZ-30596 JZ-30597

JZ-30598

JZ-30599



JZ-30600

JZ-30601

JZ-30602

JZ-30603

JZ-30604

JZ-30605



JZ-30606

JZ-30607

JZ-30608

JZ-30609

JZ-30610

JZ-30611



JZ-30612

JZ-30613

JZ-30614

JZ-30615

JZ-30616

JZ-30617



JZ-30618

JZ-30619

JZ-30620

JZ-30621

JZ-30622

JZ-30623



JZ-30624



JZ-30625



JZ-30626



JZ-30627



JZ-30628



JZ-30629



JZ-30630



JZ-30631



JZ-30632



JZ-30633



JZ-30634



JZ-30635



JZ-30636



JZ-30637



JZ-30638



JZ-30639



JZ-30640



JZ-30641



JZ-30642



JZ-30643



JZ-30644



JZ-30645



JZ-30646



JZ-30647



JZ-30648



JZ-30649



JZ-30650



JZ-30651



JZ-30652



JZ-30653



JZ-30654



JZ-30655



JZ-30656



JZ-30657



JZ-30721



JZ-30722



JZ-30658



JZ-30660



JZ-30661



JZ-30662



JZ-30663



JZ-30664



JZ-30723



JZ-30665



JZ-30666



JZ-30668



JZ-30669



JZ-30670



JZ-30671



JZ-30720



JZ-30672



**PEGASUS**  
EX3200  
EX5100  
MX3200



JZ-30676



JZ-30677



JZ-30678



JZ-30679



JZ-30680



JZ-30681



JZ-30682



JZ-30683



JZ-30684



JZ-30685



JZ-30686



JZ-30687



JZ-30688



JZ-30689



JZ-30690



JZ-30691



JZ-30692



JZ-30693



JZ-30694



JZ-30695



JZ-30696



JZ-30697



JZ-30698



JZ-30699



JZ-30700



JZ-30701



JZ-30702



JZ-30703



JZ-30704



JZ-30705



JZ-30706



JZ-30707



JZ-30708



JZ-30709



JZ-30711



JZ-30712



JZ-30713



JZ-30724



JZ-30714



JZ-30715



JZ-30716



JZ-30717



JZ-30718

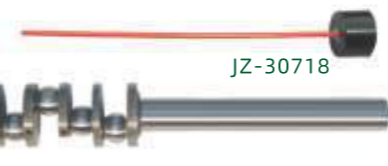

JZ-30719

**SIRUBA**  
VC008



JZ-30761



JZ-30762



JZ-30763



JZ-30805



JZ-30764



JZ-30765



JZ-30766



JZ-30767



JZ-30768



JZ-30769



JZ-30770



JZ-30771



JZ-30772



JZ-30773



JZ-30774



JZ-30775



JZ-30776



JZ-30777



JZ-30778



JZ-30779



JZ-30780



JZ-30781



JZ-30782



JZ-30783



JZ-30784



JZ-30785



JZ-30786



JZ-30787



JZ-30788



JZ-30789



JZ-30790



JZ-30791



JZ-30792



JZ-30793



JZ-30794



JZ-30795



JZ-30800



JZ-30802



JZ-30808



JZ-30809



JZ-30796



JZ-30797



JZ-30804



JZ-30810



JZ-30811



JZ-30798



JZ-30801



JZ-30803



JZ-30812



JZ-30813



JZ-30799



JZ-30806



JZ-30807



JZ-30808



JZ-30809



JZ-30810



SIRUBA

F007、C007



JZ-35001



JZ-35002



JZ-35003 JZ-35004



JZ-35005



JZ-35006



JZ-35047



JZ-35048



JZ-35049



JZ-35050



JZ-35051



JZ-35052 JZ-35053



JZ-35007



JZ-35008



JZ-35009



JZ-35010



JZ-35011



JZ-35012



JZ-35054



JZ-35055



JZ-35056



JZ-35057



JZ-35058



JZ-35059



JZ-35013



JZ-35014



JZ-35015



JZ-35016



JZ-35017



JZ-35018



JZ-35060



JZ-35061



JZ-35062



JZ-35063



JZ-35064



JZ-35065



JZ-35019



JZ-35020



JZ-35021



JZ-35022



JZ-35023



JZ-35024



JZ-35025



JZ-35026



JZ-35027



JZ-35028



JZ-35029



JZ-35030



JZ-35066



JZ-35067



JZ-35068



JZ-35069



JZ-35070



JZ-35072



JZ-35031



JZ-35032



JZ-35033



JZ-35034



JZ-35035



JZ-35036



JZ-35073



JZ-35074



JZ-35075



JZ-35076



JZ-35077



JZ-35078



JZ-35037



JZ-35038



JZ-35039



JZ-35040



JZ-35041



JZ-35042



JZ-35079



JZ-35080



JZ-35081



JZ-35082



JZ-35083



JZ-35084



JZ-35085



JZ-35086



JZ-35087



JZ-35088



JZ-35089



JZ-35090



JZ-35043



JZ-35044



JZ-35045



JZ-35046



JZ-35091



JZ-35092



JZ-35093



JZ-35094



JZ-35095



SIRUBA  
747/757



JZ-35151



JZ-35152



JZ-35153



JZ-35154



JZ-35155



JZ-35156



JZ-35157



JZ-35158



JZ-35159



JZ-35160



JZ-35161



JZ-35162



JZ-35163



JZ-35164



JZ-35165



JZ-35166



JZ-35167



JZ-35168



JZ-35169



JZ-35170



JZ-35171



JZ-35172



JZ-35173



JZ-35174



JZ-35175



JZ-35176



JZ-35177



JZ-35178



JZ-35179



JZ-35180



JZ-35181



JZ-35182



JZ-35183



JZ-35184



JZ-35185



JZ-35186



JZ-35187



JZ-35188



JZ-35189



JZ-35190



JZ-35191



JZ-35192



JZ-35193



JZ-35194



JZ-35195



JZ-35196



JZ-35197



JZ-35198



JZ-35199



JZ-35200



JZ-35201



JZ-35202



JZ-35203



JZ-35204



JZ-35205



JZ-35206



JZ-35207



JZ-35208



JZ-35209



JZ-35210



JZ-35211



JZ-35212



JZ-35213



JZ-35214



JZ-35215



JZ-35216



JZ-35217



JZ-35218



JZ-35219



JZ-35220



JZ-35221



JZ-35222



JZ-35223



JZ-35224



JZ-35225



JZ-35226



JZ-35227



JZ-35228



JZ-35229



JZ-35236



JZ-35230



JZ-35231



JZ-35234



JZ-35237



JZ-35238



JZ-35232



JZ-35233



JZ-35235



JZ-35239



JZ-35241



JZ-35240































































































SIRUBA

988





**Kingtex**  
宝狮 SH7000

	 JZ-39001	 JZ-39002	 JZ-39003	 JZ-39004	 JZ-39005		 JZ-39047	 JZ-39048	 JZ-39049	 JZ-39050	 JZ-39051	 JZ-39052
 JZ-39006	 JZ-39007	 JZ-39008	 JZ-39009	 UL603886	 5212LL0002		 JZ-39053	 JZ-39054	 JZ-39055	 JZ-39056	 JZ-39057	 JZ-39058
 JZ-39012	 JZ-39013	 JZ-39014	 JZ-39015	 JZ-39016	 JZ-39017		 JZ-39059	 JZ-39060	 JZ-39061	 JZ-39062	 JZ-39063	 JZ-39064
 JZ-39018	 JZ-39019	 JZ-39020	 JZ-39021	 JZ-39022	 JZ-39023		 JZ-39065	 JZ-39066	 JZ-39067	 JZ-39068	 JZ-39069	 JZ-39070
 JZ-39024	 JZ-39025	 JZ-39026	 JZ-39027	 JZ-39028	 JZ-39029		 JZ-39071	 JZ-39072	 JZ-39073	 JZ-39074	 JZ-39075	 JZ-39076
 JZ-39030	 JZ-39031	 JZ-39032	 JZ-39033	 JZ-39034	 JZ-39035		 JZ-39077	 JZ-39078	 JZ-39079	 JZ-39080	 JZ-39081	 JZ-39082
 JZ-39036	 JZ-39037	 JZ-39038	 JZ-39039	 JZ-39040	 JZ-39041		 JZ-39083	 JZ-39084	 JZ-39085	 JZ-39086	 JZ-39087	 JZ-39088
 JZ-39042	 JZ-39043	 JZ-39044	 JZ-39045	 JZ-39046		 JZ-39089	 JZ-39090	 JZ-39091	 JZ-39092	 JZ-39093		



KANSAI

关西 1404



JZ-40001



JZ-40002



JZ-40003



JZ-40004



JZ-40005



JZ-40047 JZ-40048



JZ-40049 JZ-40050



JZ-40051



JZ-40052



JZ-40053



JZ-40054



JZ-40006



JZ-40007



JZ-40008



JZ-40009



JZ-40010



JZ-40011



JZ-40055



JZ-40056

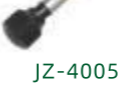

JZ-40057

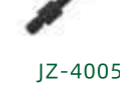

JZ-40058

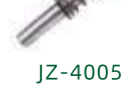

JZ-40059



JZ-40060



JZ-40012



JZ-40013



JZ-40014



JZ-40015



JZ-40016



JZ-40017



JZ-40061



JZ-40062



JZ-40063



JZ-40064



JZ-40065



JZ-40066



JZ-40018



JZ-40019



JZ-40020



JZ-40021



JZ-40022



JZ-40023



JZ-40067



JZ-40068



JZ-40069



JZ-40070

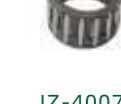

JZ-40071



JZ-40072



JZ-40024



JZ-40025



JZ-40026



JZ-40027



JZ-40028



JZ-40029



JZ-40073



JZ-40074



JZ-40075



JZ-40076



JZ-40077



JZ-40078



JZ-40030



JZ-40031



JZ-40032



JZ-40033



JZ-40034



JZ-40035



JZ-40079



JZ-40080



63-711  
JZ-40081



JZ-40082



63-713  
JZ-40096



63-621  
JZ-40097



JZ-40036



JZ-40039



JZ-40040



JZ-40041



JZ-40042



JZ-40044



JZ-40045



JZ-40083



JZ-40084



JZ-40085



JZ-40086



JZ-40087



JZ-40088



JZ-40037

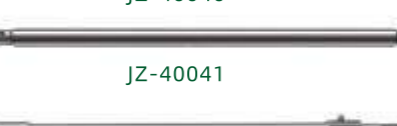

JZ-40043



JZ-40038



JZ-40046



JZ-40089 JZ-40090



JZ-40091

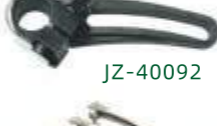

JZ-40092



JZ-40094



JZ-40093



JZ-40095



JZ-40098



JZ-40099



KANSAI

关西 1508



JZ-40151



JZ-40152



JZ-40153



JZ-40154



JZ-40155



JZ-40156



JZ-40157



JZ-40158



JZ-40159



JZ-40160



JZ-40161



JZ-40162



JZ-40163



JZ-40164



JZ-40165



JZ-40166



JZ-40167



JZ-40168



JZ-40169



JZ-40170



JZ-40171



JZ-40172



JZ-40173



JZ-40174



JZ-40175



JZ-40176



JZ-40177



JZ-40178



JZ-40179



JZ-40180



JZ-40185



JZ-40186



JZ-40187



JZ-40188

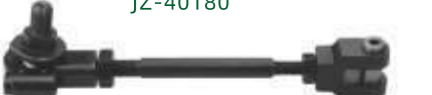

JZ-40181



JZ-40182



JZ-40189



JZ-40191



JZ-40192



JZ-40193



JZ-40183



JZ-40184



JZ-40190



JZ-40194



JZ-40195

JZ-40196

KANSAI

关西 33 针



JZ-40301



JZ-40302



JZ-40303



JZ-40304



JZ-40305



JZ-40306



JZ-40307



JZ-40308



JZ-40309



JZ-40310



JZ-40311



JZ-40312



JZ-40313



JZ-40314



JZ-40315



JZ-40316



JZ-40317



JZ-40318



JZ-40319



JZ-40320



JZ-40321



JZ-40322



JZ-40323



JZ-40324



JZ-40325



JZ-40326



JZ-40327



JZ-40328



JZ-40329



JZ-40330



JZ-40331



JZ-40332



JZ-40333



JZ-40334



JZ-40335



JZ-40336



JZ-40501



JZ-40502



JZ-40503



JZ-40504



JZ-40505



JZ-40506



**Yamato**  
大和 AZ8500





**Yamato**  
大和 1500



JZ-45091



JZ-45092



JZ-45093



JZ-45094



JZ-45095 JZ-45096



JZ-45097



JZ-45098



JZ-45099



JZ-45100



JZ-45101



JZ-45102



JZ-45103



JZ-45104



JZ-45105



JZ-45106



JZ-45107



JZ-45108



JZ-45109



JZ-45110



JZ-45111



JZ-45112



JZ-45113



JZ-45114



JZ-45115



JZ-45116



JZ-45117



JZ-45118



JZ-45119



JZ-45120



JZ-45121



JZ-45122



JZ-45123



JZ-45124



JZ-45125



JZ-45126



JZ-45128



JZ-45131



JZ-45133



JZ-45129



JZ-45134



JZ-45127



JZ-45130



JZ-45132



JZ-45135



JZ-45136



JZ-45137



JZ-45138



JZ-45139



JZ-45140



JZ-45141



JZ-45142



JZ-45143



JZ-45144



JZ-45145



JZ-45146



JZ-45147



JZ-45148



JZ-45149



JZ-45150



JZ-45151



JZ-45152



JZ-45153



JZ-45154



JZ-45155



JZ-45156



JZ-45157



JZ-45158



JZ-45159



JZ-45160



JZ-45161



JZ-45162



JZ-45163



JZ-45164



JZ-45165



JZ-45166



JZ-45167



JZ-45168



JZ-45169



JZ-45170



JZ-45172



JZ-45173



JZ-45174



JZ-45175



JZ-45176

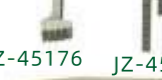

JZ-45177



JZ-45178



JZ-45179

JZ-45180



JZ-45181



JZ-45182



**Jamato**  
大和 1500



**Jamato**  
大和 2500





**Ijamato**

大和 2500  
大和 2700



**Ijamato**

VG3721

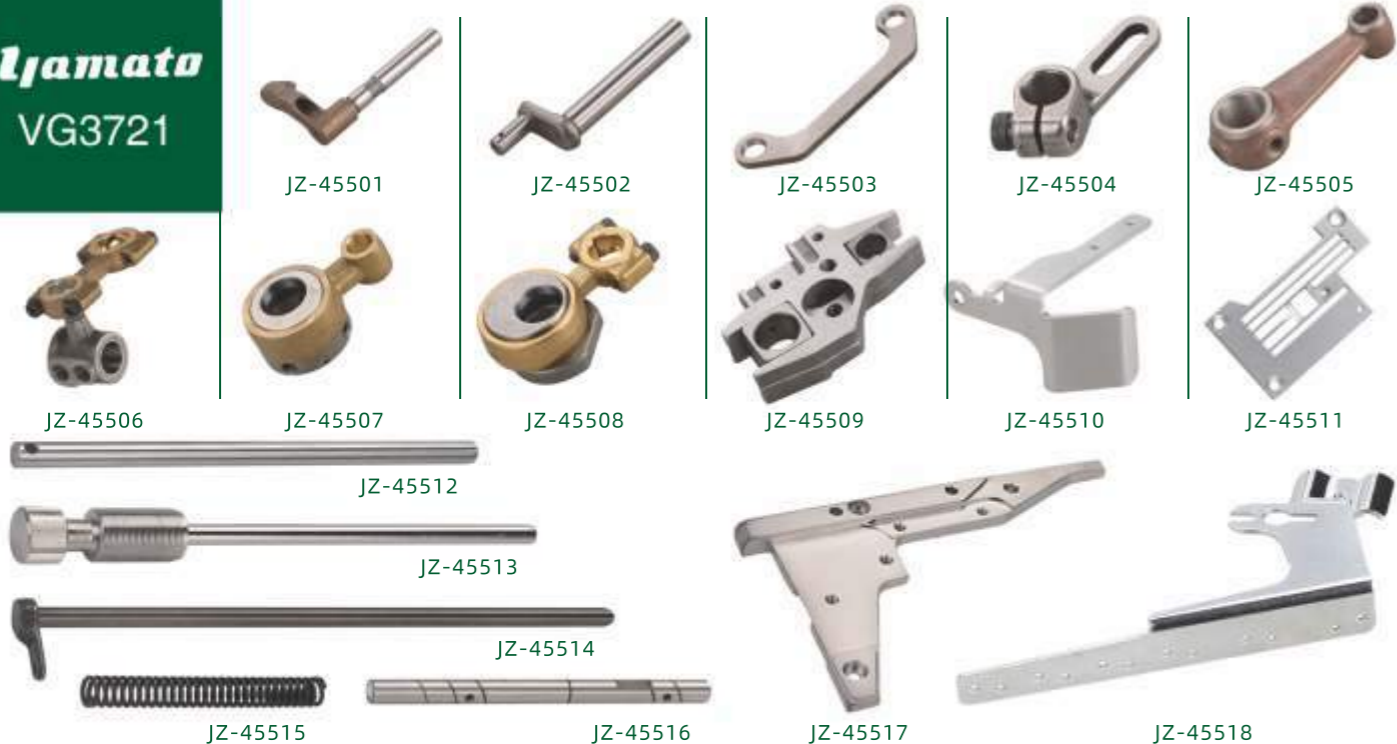



**Ujamoto**  
四针六线



## Ujamoto

FD-62G-01MR

JZ-45742

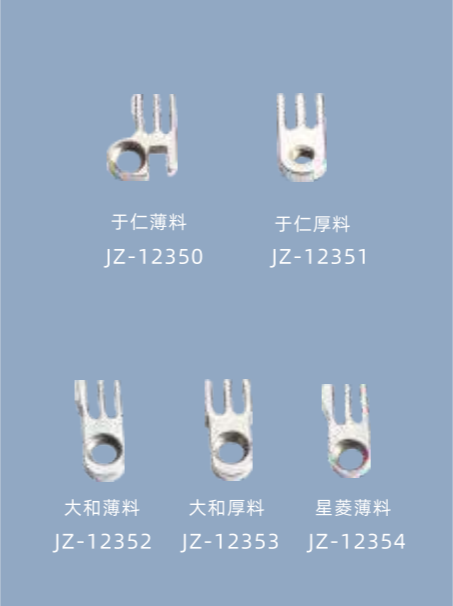
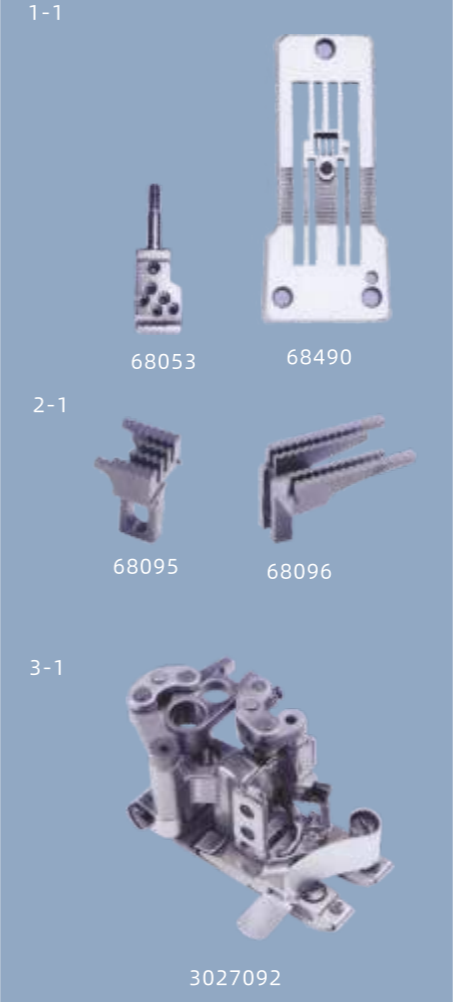

## PEGASUS

FS700

JZ-45743



## SHING LING

SL-700

JZ-45744





SHING LING  
星菱777





SHING LING

星菱777



JZ-47113

SHING LING

星菱SL700



JZ-47306



JZ-47312



JZ-47318



JZ-47324



JZ-47330



JZ-47335



JZ-47108



JZ-47114



JZ-47301



JZ-47307



JZ-47313



JZ-47319



JZ-47325



JZ-47331



JZ-47336



JZ-47109



JZ-47115



JZ-47302



JZ-47308



JZ-47314

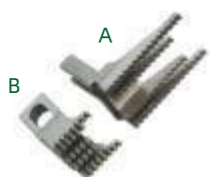

JZ-47320



JZ-47326



JZ-47332

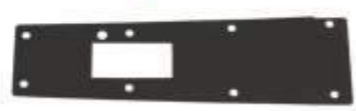

JZ-47337



JZ-47110



JZ-47116



JZ-47303



JZ-47309



JZ-47315



JZ-47321



JZ-47327



JZ-47333



JZ-47111



JZ-47117



JZ-47304



JZ-47310



JZ-47316



JZ-47322



JZ-47328



JZ-47334



JZ-47338



JZ-47339



JZ-47112



JZ-47118



JZ-47305



JZ-47311



JZ-47317



JZ-47323



JZ-47329



JZ-47340



JZ-47347



JZ-47354



JZ-47361



JZ-47368



JZ-47375



JZ-47382



JZ-47388



JZ-47389



JZ-47390



JZ-47341



JZ-47348



JZ-47355



JZ-47362



JZ-47369



JZ-47376



JZ-47383



JZ-47388



JZ-47389



JZ-47390



JZ-47342



JZ-47349



JZ-47356



JZ-47363



JZ-47370



JZ-47377



JZ-47384



JZ-47391



JZ-47392



JZ-47393



JZ-47343



JZ-47350



JZ-47357



JZ-47364



JZ-47371



JZ-47378



JZ-47385



JZ-47394



JZ-47392



JZ-47393



JZ-47344



JZ-47351



JZ-47358



JZ-47365



JZ-47372



JZ-47379



JZ-47387



JZ-47394



JZ-47392



JZ-47393



JZ-47345



JZ-47352



JZ-47359



JZ-47366



JZ-47373



JZ-47380



JZ-47386



JZ-47395



JZ-47396

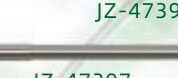

JZ-47397



JZ-47346



JZ-47353



JZ-47360



JZ-47367



JZ-47374



JZ-47381



JZ-47386



JZ-47395



JZ-47396



JZ-47397





558



JZ-49001



JZ-49002



JZ-49003



JZ-49004



JZ-49005



JZ-49048



JZ-49049



JZ-49050



JZ-49051



JZ-49052



JZ-49053



JZ-49006



JZ-49007



JZ-49008



JZ-49009



JZ-49010



JZ-49011



JZ-49054



JZ-49055



JZ-49056



JZ-49057



JZ-49058



JZ-49059



JZ-49012



JZ-49013



JZ-49014



JZ-49015



JZ-49016



JZ-49017



JZ-49060



JZ-49061



JZ-49062



JZ-49063



JZ-49064



JZ-49065



JZ-49018



JZ-49019



JZ-49020



JZ-49021



JZ-49022



JZ-49023



JZ-49024



JZ-49025



JZ-49026



JZ-49027



JZ-49028



JZ-49029



JZ-49072



JZ-49073



JZ-49074



JZ-49075



JZ-49076



JZ-49077



JZ-49030



JZ-49031



JZ-49032



JZ-49033



JZ-49034



JZ-49035



JZ-49078



JZ-49079



JZ-49080



JZ-49081



JZ-49082



JZ-49083



JZ-49036



JZ-49037



JZ-49038



JZ-49039



JZ-49040



JZ-49041



JZ-49084



JZ-49085



JZ-49088



JZ-49086



JZ-49087



JZ-49042



JZ-49043



JZ-49044



JZ-49045



JZ-49046



JZ-49047



JZ-49089



JZ-49090



JZ-49093



JZ-49091



JZ-49092



JZ-49093



**SINGER**  
**胜家 20U**



JZ-51001



JZ-51002



JZ-51003



JZ-51004



JZ-51005



JZ-51047



JZ-51048



JZ-51049



JZ-51050 JZ-51051



JZ-51052



JZ-51053



JZ-51006



JZ-51007



JZ-51008



JZ-51009



JZ-51010



JZ-51011



JZ-51054



JZ-51055



JZ-51056



JZ-51057



JZ-51058



JZ-51059



JZ-51012



JZ-51013



JZ-51014



JZ-51015



JZ-51016



JZ-51017



JZ-51060



JZ-51061



JZ-51062



JZ-51063



JZ-51064



JZ-51065



JZ-51018



JZ-51019



JZ-51020



JZ-51021



JZ-51022



JZ-51023



JZ-51066



JZ-51067



JZ-51068



JZ-51069



JZ-51070



JZ-51071



JZ-51024



JZ-51025



JZ-51026



JZ-51027



JZ-51028



JZ-51029



JZ-51072



JZ-51073



JZ-51074



JZ-51075



JZ-51076



JZ-51077



JZ-51030



JZ-51031



JZ-51036



JZ-51037



JZ-51043



JZ-51032



JZ-51033



JZ-51034



JZ-51035



JZ-51078



JZ-51079



JZ-51080



JZ-51081



JZ-51082



JZ-51083



JZ-51038



JZ-51039



JZ-51040



JZ-51041



JZ-51084



JZ-51085



JZ-51086



JZ-51087



JZ-51088



JZ-51089



JZ-51094

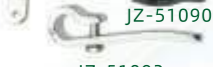

JZ-51090



JZ-51093 JZ-51095

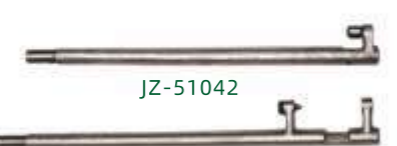

JZ-51042

JZ-51044



JZ-51045



JZ-51046



JZ-51096

JZ-51099

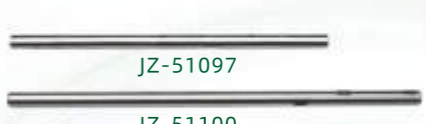

JZ-51097

JZ-51100



JZ-51098

JZ-51101



## NEWLONG NP-7 GK26

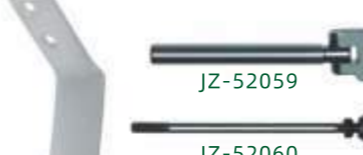
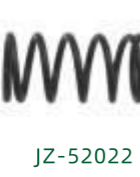
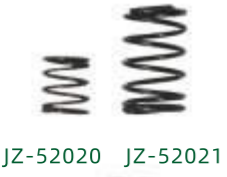

## PFAFF 百福 335

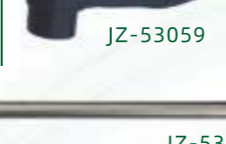
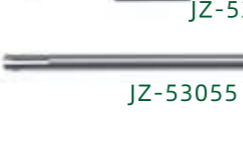
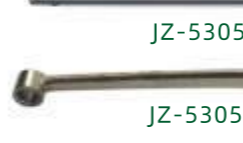
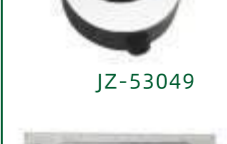
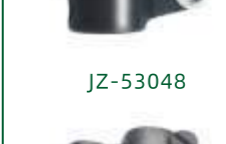



高头车  
810.820

 JZ-54001	 JZ-54002	 JZ-54003	 JZ-54004	 JZ-54005	 JZ-54006	 JZ-54060	 JZ-54061	 JZ-54062	 JZ-54063	 JZ-54064	 JZ-54065	 JZ-54066
 JZ-54007	 JZ-54008	 JZ-54009	 JZ-54010	 JZ-54011	 JZ-54012	 JZ-54067	 JZ-54068	 JZ-54069	 JZ-54070	 JZ-54071	 JZ-54072	
 JZ-54013	 JZ-54014	 JZ-54015	 JZ-54016	 JZ-54017	 JZ-54018	 JZ-54073	 JZ-54074	 JZ-54075	 JZ-54076	 JZ-54077	 JZ-54078	
 JZ-54019	 JZ-54020	 JZ-54021	 JZ-54022	 JZ-54023	 JZ-54024	 JZ-54079	 JZ-54080	 JZ-54081	 JZ-54082	 JZ-54083	 JZ-54084	
 JZ-54025	 JZ-54026	 JZ-54027	 JZ-54028	 JZ-54029	 JZ-54030	 JZ-54085	 JZ-54086	 JZ-54087	 JZ-54088	 JZ-54089	 JZ-54090	
 JZ-54031	 JZ-54032	 JZ-54033	 JZ-54034	 JZ-54035	 JZ-54036	 JZ-54093	 JZ-54093	 JZ-54093	 JZ-54116	 JZ-54116	 JZ-54116	
 JZ-54037	 JZ-54038	 JZ-54039	 JZ-54040	 JZ-54041	 JZ-54042	 JZ-54095	 JZ-54096	 JZ-54097	 JZ-54098	 JZ-54099	 JZ-54114	
 JZ-54043	 JZ-54044	 JZ-54045	 JZ-54046	 JZ-54047	 JZ-54048	 JZ-54099	 JZ-54100	 JZ-54101	 JZ-54102	 JZ-54103	 JZ-54115	
 JZ-54045	 JZ-54046	 JZ-54047	 JZ-54048	 JZ-54049	 JZ-54050	 JZ-54102	 JZ-54103	 JZ-54104	 JZ-54105	 JZ-54106	 JZ-54115	
 JZ-54049	 JZ-54050	 JZ-54051	 JZ-54052	 JZ-54053	 JZ-54054	 JZ-54104	 JZ-54105	 JZ-54106	 JZ-54107	 JZ-54108	 JZ-54115	
 JZ-54057	 JZ-54058	 JZ-54059	 JZ-54060	 JZ-54061	 JZ-54062	 JZ-54107	 JZ-54108	 JZ-54109	 JZ-54110	 JZ-54111	 JZ-54115	
 JZ-54057	 JZ-54058	 JZ-54059	 JZ-54060	 JZ-54061	 JZ-54062	 JZ-54110	 JZ-54111	 JZ-54112	 JZ-54113	 JZ-54114	 JZ-54115	
 JZ-54057	 JZ-54058	 JZ-54059	 JZ-54060	 JZ-54061	 JZ-54062	 JZ-54111	 JZ-54112	 JZ-54113	 JZ-54114	 JZ-54115	 JZ-54115	



罗拉车  
591



JZ-54206



JZ-54212



JZ-54218



JZ-54224



JZ-54230



JZ-54201



JZ-54207



JZ-54213



JZ-54219



JZ-54225



JZ-54231



JZ-54202



JZ-54208



JZ-54214



JZ-54220



JZ-54226



JZ-54232



JZ-54203



JZ-54209



JZ-54215



JZ-54221



JZ-54227



JZ-54233



JZ-54204



JZ-54210



JZ-54216



JZ-54222



JZ-54228



JZ-54234



JZ-54205



JZ-54211



JZ-54217



JZ-54223



JZ-54229



JZ-54235



JZ-54236



JZ-54237



JZ-54238



JZ-54239



JZ-54240



JZ-54241



JZ-54242



91-150739-04/B4.5  
91-150737-93/B4.5  
JZ-54301



91-150739-04/C(4.5 7.0)  
91-150783-93/C(4.5 7.0)  
JZ-54305



91-150882-25  
91-150877-93  
JZ-54309



Z-91-175534-24-302 C7.0  
Z-91-175536-302 C7.0  
JZ-54313



91-150336-04/91-150955-93  
(1.2 1.5 2.0 2.5)  
JZ-54317



91-186016-24/1.8  
91-184034-93/1.8H  
JZ-54321



91-150635-X4/2.2-2.4  
91-150914-23/2.2-2.4  
JZ-54325



91-150739-04/C(4.5 7.0)  
91-150737-93/C(4.5 7.0)  
JZ-54302



91-150739-93/B4.5  
91-175279-93/B4.5  
JZ-54306



91-150868-24  
91-150879-93  
JZ-54310



Z-91-186295-303 M4.5  
Z-91-186297-303 M4.5  
JZ-54314



91-150747-04/1.5  
91-150960-93/001(1.5)  
JZ-54318



91-175044-24/1.8  
91-186049-93/1.8H  
JZ-54322



91-175551-24-301 AN1.2-1.8  
91-175552-301 AN1.2-1.8  
JZ-54326



91-150737-93/B4.5  
91-150783-93/B4.5  
JZ-54303



91-150739-04/C(4.5 7.0)  
91-175279-93/C(4.5 7.0)  
JZ-54307



91-150882-25  
91-150880-93  
JZ-54311



Z-91-186295-304 H4.5  
Z-91-186297-304 H4.5  
JZ-54315



91-150635-X4/1.8-2.0  
91-150914-23/1.8-2.0  
JZ-54319



91-150625-04/(1.2-2.8)  
91-150728-91/(1.2-2.8)  
JZ-54323



811-3(2.4mm)  
811-3-1(2.4mm)  
JZ-54327



811-3A(2.0mm/2.5mm)  
JZ-54304



811-3(Ø2.5 2.8)  
JZ-54308



820-D3(1.5mm)  
JZ-54312



0768-202010针板  
0768-212010牙  
JZ-54316



91-048321C  
JZ-54320



09-006A-9677 自动剪线  
JZ-54324



GP-018471-00(Ø2.8X4.6mm)  
JZ-54328



罗拉车  
9901



TYPICAL  
标准 341

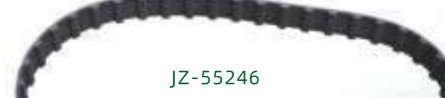
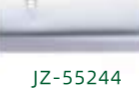



**TYPICAL**  
标准  
0302/0318





精工  
8B



SINGER  
胜家 591



削皮机  
801





## Eastman 伊士曼电剪

 JZ-57001	 JZ-57002	 JZ-57003	 JZ-57004	 JZ-57005 (5" 8" 10")	 JZ-57006 (5" 8" 10")	 JZ-57007	 JZ-57008				
 JZ-57009	 JZ-57010	 JZ-57011	 JZ-57012	 JZ-57013	 JZ-57014	 JZ-57015	 JZ-57016	 JZ-57017			
 JZ-57018	 JZ-57019	 JZ-57020	 JZ-57021	 JZ-57022	 JZ-57023	 JZ-57024	 JZ-57025	 JZ-57026	 JZ-57027	 JZ-57028	 JZ-57029
 JZ-57030	 JZ-57031	 JZ-57032	 JZ-57033	 JZ-57034	 JZ-57035	 JZ-57036	 JZ-57037	 JZ-57038	 JZ-57039	 JZ-57040	
 JZ-57041	 JZ-57042	 JZ-57043	 带轴承 WITH BEARING	 带轴承 WITH BEARING	 JZ-57047	 JZ-57048	 JZ-57049	 JZ-57050			
 JZ-57051	 JZ-57052	 JZ-57053	 JZ-57054	 JZ-57055	 JZ-57056	 JZ-57057	 JZ-57063	 JZ-57128			
 JZ-57058	 JZ-57059 (5" 8" 10")	 JZ-57060 (5" 8" 10")	 JZ-57061	 JZ-57062	 JZ-57130	 JZ-57131	 JZ-57069	 JZ-57070	 JZ-57071	 JZ-57072	 JZ-57073 (5" 8" 10")
 JZ-57065	 JZ-57066	 JZ-57129	 JZ-57067 (5" 8" 10")	 JZ-57068 (5" 8" 10")	 JZ-57069	 JZ-57070	 JZ-57071	 JZ-57072	 JZ-57073 (5" 8" 10")		

 JZ-57074	 JZ-57075	 JZ-57076	 JZ-57077	 JZ-57078	 JZ-57079
 JZ-57081	 JZ-57082	 JZ-57083	 JZ-57084	 JZ-57085	 JZ-57086
 JZ-57087	 JZ-57088	 JZ-57089	 JZ-57090	 JZ-57091	 JZ-57092
 JZ-57097	 JZ-57064	 JZ-57099	 JZ-57100	 JZ-57101	 JZ-57102
 JZ-57103	 JZ-57104	 JZ-57105	 JZ-57106	 JZ-57107	 JZ-57108
 JZ-57109	 JZ-57110	 JZ-57111	 JZ-57112	 JZ-57113	 JZ-57114
 JZ-57115	 JZ-57116	 JZ-57117	 JZ-57118	 JZ-57119	 JZ-57120
 JZ-57121	 JZ-57122	 JZ-57123	 JZ-57124	 JZ-57125	



**kmsh**  
KM 电剪



JZ-58001



JZ-58002 JZ-58003



JZ-58004 JZ-58005



JZ-58006 JZ-58007



JZ-58008



JZ-58009



JZ-58010



JZ-58011



JZ-58012



JZ-58013



JZ-58014



JZ-58015



JZ-58016



JZ-58017



JZ-58018



JZ-58019



JZ-58020



JZ-58021



JZ-58022



JZ-58023



JZ-58024



JZ-58025



JZ-58026 JZ-58027



JZ-58028  
JZ-58029



JZ-58030



JZ-58032



JZ-58033



JZ-58034



JZ-58035



JZ-58097



JZ-58036



JZ-58038



JZ-58039



JZ-58040



JZ-58041



JZ-58042



JZ-58043



JZ-58044



JZ-58045



JZ-58046



JZ-58047



JZ-58048



JZ-58049  
(5" 8" 10")



JZ-58050



JZ-58051



JZ-58052



JZ-58053



JZ-58054 JZ-58094



JZ-58055



JZ-58056



JZ-58057



JZ-58058



JZ-58060



JZ-58061



JZ-58062 JZ-58063



JZ-58064



JZ-58065



JZ-58066



JZ-58067



JZ-58068



JZ-58069



JZ-58070



JZ-58071



JZ-58072



JZ-58073



JZ-58074



JZ-58075



JZ-58076



JZ-58077



JZ-58078



JZ-58079



JZ-58080



JZ-58081



JZ-58083



JZ-58084



JZ-11301

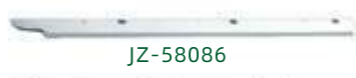

JZ-58086



JZ-58087

(5" 8" 10")



JZ-58088

(5" 8" 10")



JZ-58089

(5" 8" 10")



JZ-58090

(5" 8" 10")



JZ-58091

(5" 8" 10")



JZ-58095



JZ-58096



JZ-58092  
(5" 8" 10")



断布机



JZ-59001



JZ-59002



JZ-59003



JZ-59004



JZ-59005



JZ-59006



JZ-59007



JZ-59008



JZ-59009



JZ-59010



JZ-59011



JZ-59012



JZ-59013



JZ-59014



JZ-59015



JZ-59016



JZ-59017



JZ-59018



JZ-59019



JZ-59020



JZ-59021



JZ-59023



JZ-59022



JZ-59024



JZ-59025



JZ-59028



JZ-59026



JZ-59027

圆刀机  
RS-90  
RS-100



JZ-60001



JZ-60002



JZ-60003



JZ-60004 JZ-60005



JZ-60006



JZ-60007 JZ-60008



JZ-60009



JZ-60010



JZ-60011



JZ-60012



JZ-60013



JZ-72409 JZ-60014

JZ-60048



JZ-60015



JZ-60016



JZ-60017



JZ-60019



JZ-60020



JZ-60021 JZ-60022



JZ-60023

RS90



JZ-60027



JZ-60049

RS100 火连



JZ-60028



JZ-60050

RS100 乐江



JZ-60029



JZ-60024

RS100



JZ-60030



JZ-60025

RS100



JZ-60031



JZ-60026



JZ-60032



JZ-60033



JZ-60034



JZ-60035



JZ-60036



JZ-60037



JZ-60038



JZ-60039



JZ-60040



JZ-60041



JZ-60042



JZ-60043



JZ-60044



JZ-60045



JZ-60046



JZ-60047





**JINZEN®**  
胶订机 JZ-9000



JZ-62020



胶订机  
JZ-9000





**家用机**  
 JA1-1  
 JA2-1

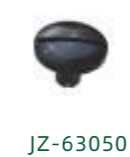

Ø111  
 Ø115  
 Ø118  
 Ø120  
 Ø123  
 Ø131

MB350  
 MB360  
 M7370  
 MB380  
 MB390  
 MB400  
 MB420



家用机  
多功能  
307





**SINGER**  
胜家  
974



JZ-63506



JZ-63512



JZ-63518



JZ-63524



JZ-63530



JZ-63536



JZ-63501



JZ-63507



JZ-63513



JZ-63519



JZ-63525



JZ-63531



JZ-63537



JZ-63502



JZ-63508



JZ-63514



JZ-63520



JZ-63526



JZ-63532



JZ-63538



JZ-63503



JZ-63509



JZ-63515



JZ-63521



JZ-63527



JZ-63533



JZ-63539



JZ-63504



JZ-63510



JZ-63516



JZ-63522



JZ-63528



JZ-63534



JZ-63540



JZ-63505



JZ-63511



JZ-63517



JZ-63523



JZ-63529



JZ-63535



JZ-63541

JZ-63545

JZ-63546

JZ-63547

JZ-63548



JZ-63549



JZ-63555



JZ-63561



JZ-63567



JZ-63587



JZ-63550



JZ-63556



JZ-63562



JZ-63568



JZ-63573



JZ-63578



JZ-63551



JZ-63557



JZ-63563



JZ-63569



JZ-63574



JZ-63579



JZ-63552



JZ-63558



JZ-71343



JZ-63570



JZ-63575



JZ-63580



JZ-63553



JZ-63559



JZ-71342



JZ-63571



JZ-63576



JZ-63581



JZ-63554



JZ-63560



JZ-63566



JZ-63572



JZ-63577



JZ-63582



JZ-63583

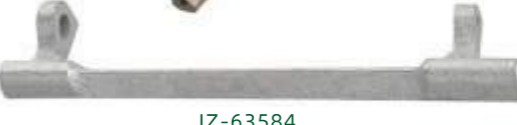

JZ-63584



JZ-63585



JZ-63586



JZ-63588



JZ-63589



JZ-63542



JZ-63543



JZ-63544



JZ-63545

JZ-63546

JZ-63547

JZ-63548



brother  
多功能  
5500



JZ-64001



JZ-64002



JZ-64003



JZ-64004



JZ-64005



JZ-64006



JZ-64007



JZ-64008



JZ-64009



JZ-64010



JZ-64011



JZ-64012



JZ-64013



JZ-64014



JZ-64015



JZ-64016



JZ-64017



JZ-64018



JZ-64019



JZ-64020



JZ-64021



JZ-64022



JZ-64023



JZ-64024



JZ-64025



JZ-64026



JZ-64027



JZ-64029



JZ-64030



JZ-64031



JZ-64032



JZ-64033



JZ-64034



JZ-64035



JZ-64036



JZ-64037



JZ-64038



JZ-64039



JZ-64040



JZ-64041



JZ-64042



JZ-64043



JZ-64044



JZ-64045



JZ-64046



JZ-64047



JZ-64048



JZ-64049

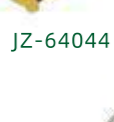

JZ-64050

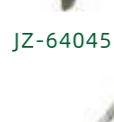

JZ-64051

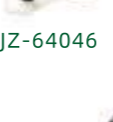

JZ-64052

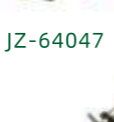

JZ-64053

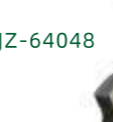

JZ-64054



JZ-64055



JZ-64056



JZ-64057



JZ-64058



JZ-64059



JZ-64060



JZ-64061



JZ-64062



JZ-64063



JZ-64064



JZ-64065



JZ-64066



JZ-64067



JZ-64068



JZ-64069



JZ-64070



JZ-64071



JZ-64072



JZ-64073



JZ-64074



JZ-64075



JZ-64076



JZ-64077



JZ-64078



JZ-64079



JZ-64080



JZ-64081



JZ-64082



JZ-64083



JZ-64084



JZ-64085



JZ-64086



JZ-64087



JZ-64088



JZ-64089



JZ-64090



JZ-64091



JZ-64092



JZ-64093



JZ-64094



JZ-64095



JZ-64096

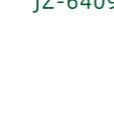

JZ-64097

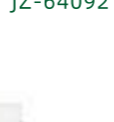

JZ-64098

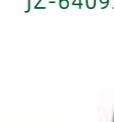

JZ-64099



JZ-64098



JZ-64099



JZ-64100

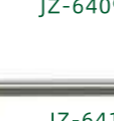

JZ-64101



JZ-64102



JZ-64103

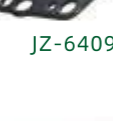

JZ-64104

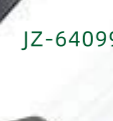

JZ-64105



JZ-64105



**JANOME**

真善美  
2049



JZ-65001



JZ-65002



JZ-65003



JZ-65004



JZ-65005



JZ-65048



JZ-65049



JZ-65050



JZ-65051



JZ-65052



JZ-65053



JZ-65006



JZ-65007



JZ-65008



JZ-65009



JZ-65010



JZ-65011



JZ-65054



JZ-65055



JZ-65056



JZ-65057



JZ-65058



JZ-65059



JZ-65012



JZ-65013



JZ-65014



JZ-65015



JZ-65016



JZ-65017



JZ-65060



JZ-65061



JZ-65062



JZ-65063



JZ-65064



JZ-65065



JZ-65018



JZ-65019



JZ-65020



JZ-65021



JZ-65022



JZ-65023

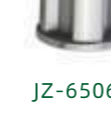

JZ-65066



JZ-65067



JZ-65068



JZ-65069



JZ-65070



JZ-65072



JZ-65024



JZ-65025



JZ-65026



JZ-65027



JZ-65028



JZ-65029



JZ-65073



JZ-65074



JZ-65075



JZ-65076



JZ-65077



JZ-711335



JZ-65030



JZ-65031



JZ-65032



JZ-65033



JZ-65034



JZ-65035



JZ-65078



JZ-65080



JZ-65081



JZ-65079



JZ-65082

JZ-65083



JZ-65036



JZ-65037



JZ-65038



JZ-65039



JZ-65040



JZ-65041



JZ-65089  
SHX3 2#  
SHX3 3#  
SHX3 4#



JZ-65090 2054 12#  
2054 14#  
2054 16#



JZ-65091 2045 12#  
2045 14#  
2045 16#



JZ-11513  
HAX1 11#  
HAX1 12#  
HAX1 14#  
HAX1 16#  
HAX1 18#



JZ-65042



JZ-65043



JZ-65044



JZ-65045



JZ-65046



JZ-65047



JZ-65084



JZ-65086

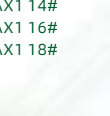

JZ-65093



暗缝机



大白扣机



修边机



JACK 杰克





# 家用多功能压脚

## Sewing Machine Feet & Accessory For Household



JZ-66000

15-PIECE STANDARD FEET SET  
Item RJ-215

JZ-66001

8-PIECE UTILITY FEET PACKAGE  
Item RJ-208

JZ-66002

JZ-66003





JZ-66004



JZ-66005

# JINZEN®

家用多功能压脚  
Sewing Machine Feet  
& Accessory For Household

 5701S JZ-66006	 5701L JZ-66007	 601Z CONCEALED ZIPPER FOOT JZ-66008	 7315 5 GROOVE PINTUCK FOOT JZ-66009	 7315W 9 GROOVE PINTUCK JZ-66010	 601ZN CONCEALED ZIPPER FOOT JZ-66011
 20000 2008 PIPING FOOT JZ-66012	 20000 3009 GATHERING FOOT JZ-66013	 7309 CORDING FOOT JZ-66014	 7313 OPEN TOE FOOT JZ-66015	 7320 BRADING FOOT JZ-66016	 7323 ZIGZAG FOOT JZ-66017
 161956 JZ-66018	 384119-457 JZ-66019	 153267 STRAIGHT STITCH FOOT JZ-66020	 5012-1 JZ-66021	 7306-2 ZIPPER FOOT JZ-66022	 7307R ROLLER HEM FOOT JZ-66023
 155962 JZ-66024	 7306 ZIPPER FOOT JZ-66025	 7309W CORDING FOOT 7MM JZ-66026	 446371 ZIGZAG FOOT JZ-66027	 7317 DITCH/EDGE JOINING FOOT JZ-66028	 7319 PATCHWORK FOOT JZ-66029
 7301 ZIGZAG FOOT JZ-66030	 7301W 7MM ZIGZAG FOOT JZ-66031	 7301G AIGZAG FOOT JZ-66032	 7301-2 ZIGZAG FOOT JZ-66033	 7301SS ZIGZAG JZ-66034	 7304 STRAIGHT STITCH JZ-66035
 7301 NG ZIGZAG FOOT NO GROOVE JZ-66036	 7322 PATCHWCRK FOOT 1/4" STRAIGHT STITCH JZ-66037	 7318 DITCH EDGE TOHINING FOOT JZ-66038	 7310 OVERCASTING PLATE JZ-66039	 7307 HEMMER FOOT JZ-66040	 7307WR ROLLER HEM FOOT 7MM JZ-66041
 P55607 JZ-66042	 7325 JZ-66043	 7306 ZIPPER FOOT JZ-66025	 7321-1 (JARAME) JZ-66045	 7321 JZ-66046	 7326 OVERCASTING PLATE JZ-66047



# 家用多功能压脚

## Sewing Machine Feet & Accessory For Household

**JINZEN®**

 701L 5 GROOVE LOW SHANK PINTUCK FOOT JZ-66048	 702 GATHERING FOOT JZ-66049	 601 LZN LOW SHANK CONCEALED ZIPPER FOOT JZ-66050	 716LW 7MM GORDING FOOT LOW SHANK JZ-66051	 720L-NLT ZIGZAG JZ-66052	 720LW 7MM LOW SHANK ZIGZAG FOOT JZ-66053	 40986X6 1/4" JZ-66084	 40986X6 3/16" JZ-66085	 40986X6 1/8" JZ-66086	 801+7301-2 SRT2 ZIGZAG FOOT JZ-66087	 8034 FOR COMPINTER SEWING ZIGZAG JZ-66088	 8012 FOR COMPUTER SEWING ZIGZAG JZ-66089
 720L LOW SHANK ZIGZAG FOOT JZ-66054	 718L OPEN TOE FOOT LOW SHANK JZ-66055	 719L STRAIGHT JZ-66056	 1895 DARNING FOOT JZ-66057	 717H HIGH SHANK HEMMER JZ-66058	 717LR ROLLER HEM FOOT LOW SHANK JZ-66059	 7316 ZIGZAG FOOT JZ-66090	 701M DARNING FOOT JZ-66091	 701 DARNING FOOT LOW SHANK JZ-66092	 7308 BLIND STITCH JZ-66093	 723L BLIND STITCH LOW SHANK JZ-66094	 PART # 29309 HOLDER JZ-66095
 717-1L ROLLER HEM FOOT LOW SHANK JZ-66060	 7322S SLANT 1/4IN STRAIGHT STITCH JZ-66061	 717L HEMMER LOW SHANK JZ-66062	 720H-NG HIGH SHANK ZIGZAG FOOT JZ-66063	 720H HIGH SHANK ZIGZAG FOOT JZ-66064	 718H HIGH SHANK OPEN TOE FOOT JZ-66065	 73081 BLIND STITCH FOOT JZ-66096	 6290 TAPE BINDE JZ-66097	 6287 LOW SHANK TAPE BINDING JZ-66098	 4021-BP DARNING FOOT JZ-66099	 4021L DARNING FOOT JZ-66100	 4021L-OT OPEN TOE DARNING FOOT JZ-66101
 712 LOW SHANK 10MM JZ-66066	 713 12MM JZ-66067	 710 LOW SHANK JZ-66068	 PART # 25910 LOW SHANK GATHERING FOOT JZ-66069	 711 LOW SHANK JZ-66070	 709 LOW SHANK JZ-66071	 P60410 LOW SHANK FREE-MOTION JZ-66102	 P60417 FREE MOTION DARNING FOOT (SLANT) JZ-66103	 4021P FREE MOTION DARNING FOOT JZ-66104	 4021P-H HIGH SHANK FREE MOTION DARNING JZ-66105	 4021HP DARNING FOOT HIGH SHANK JZ-66106	 161876-1 DARNING FOOT JZ-66107
 707 LOW SHANK GATHERING FOOT JZ-66072	 707R LOW SHANK GATHERING FOOT JZ-66073	 707S SLANT GATHERING FOOT JZ-66074	 725 STRAIGHT STITCH JZ-66075	 PART # 39196 OVERCASTING FOOT LOW SHANK JZ-66076	 714 HIGH SHANK JZ-66077	 PART # 29301 JZ-66108	 PART # 29302 1/4" HEMMER JZ-66109	 PART # 29303 1/8" HEMMER JZ-66110	 PART # 29304 5/8" HEMMER JZ-66111	 29305 7/8" JZ-66112	 29306 ELAS JZ-66113
 720H-SS HIGH SHANK ZIGZAG JZ-66078	 2555 JZ-66079	 717-15 ROLLER HEM FOOT SLANT JZ-66080	 7321L LOW SHANK JZ-66081	 7321H HIGH SHANK JZ-66082	 717-1H ROLLER HEM FOOT HIGH SHANK JZ-66083	 29307+29309 BINDER JZ-66114	 720HP HIGH SHANK ZIGZAG FOOT JZ-66115	 720LP LOW SHANK ZIGZAG FOOT JZ-66116	 P60791 LOW SHANK OPEN TOE FOOT JZ-66117	 PART # 35852 GUIDE JZ-66118	 ANT1 NEEDLE THREADER JZ-66119



家用多功能  
压脚



542167  
JZ-66120



155964  
JZ-66121



7300  
HOLDER  
JZ-66122



7300J  
LOW SHANK  
HOLDER  
JZ-66123



7300H  
HIGH SHANK  
HOLDER  
JZ-66124



507836  
JZ-66125



171480  
ZIPPER FOOT FOR SLANT  
JZ-66126



7305  
BUTTON SEW ON  
JZ-66127



A9  
APPLIQUE FOOT  
JZ-66128



446498  
JZ-66129



601  
CONCEALED ZIPPER FOOT  
JZ-66130



7301T  
ZIGZAG FOOT 7MM  
(TELFON)  
JZ-66131



7301PW  
ZIGZAG FOOT  
JZ-66132



7301P  
ZIGZAG FOOT 5MM  
JZ-66133



7303W  
SATIN STITCH 7MM  
JZ-66134



7303 5MM  
SATIN STITCH FOOT  
JZ-66135



7324  
WELTING/BRADING FOOT  
JZ-66136



7314W  
ROLLER FOOT 7MM  
JZ-66137



7314  
ROLLER FOOT 5MM  
JZ-66138



P60794W  
OPEN TOE FOOT  
JZ-66139



506377  
JZ-66140



7322P  
1/4IN FOOT  
JZ-66141



602  
STRAIGHT STITCH  
JZ-66142



720LPW  
ZIGZAG LOW SHANK  
JZ-66143



721L  
5MM SOE IN STITCH FOOT  
LOW SHANK  
JZ-66144



5615  
SATIN STITCH LOW SHANK  
JZ-66145



722H  
ROLLER FOOT HIGH SHANK  
JZ-66146



722S  
ROLLER FOOT SLANT  
JZ-66147



P60793  
OPEN TOE FOOT SLANT  
JZ-66148



721H  
SATIN STITCH FOOT  
HIGH SHANK  
JZ-66149



5554  
SATIN STITCH HIGH SHANK  
JZ-66150



708  
BUTTON SEW ON  
JZ-66151



7305L  
LOW SHANK  
BUTTON SEW ON  
JZ-66152



PART # 54612  
DARNING FOOT  
JZ-66153



7322SP  
SLANT  
1/4" STRAIGHT STITCH  
JZ-66154



703LI  
BUTTONHDE FOOT  
LOW SHANK  
JZ-66155



313992  
BUTTONHDE FOOT  
LOW SHANK  
JZ-66156



703L  
BUTTONHDE FOOT  
LOW SHANK  
JZ-66157



7302  
BUTTONHDE  
JZ-66158



1932S  
BUTTONHDE FOOT  
SLANT  
JZ-66159



706L  
LOW SHANK  
ADJUSTABLE ZIPPER  
JZ-66160



706S  
SLANT  
ADJUSTABLE ZIPPER  
JZ-66161



706H  
HIGH SHANK  
ADJUSTABLE ZIPPER  
JZ-66162



705LI  
LOW SHANK  
ADJUSTABLE ZIPPER  
JZ-66163



705L  
LOW SHANK  
ADJUSTABLE ZIPPER  
JZ-66164



705H  
HIGH SHANK  
ADJUSTABLE ZIPPER  
JZ-66165



551  
LOW SHANK  
ADJUSTABLE ZIPPER  
JZ-66166



PART # 6792  
ADJUSTABLE ZIPPER  
JZ-66167



6792-1  
ZIPPER(TELFON)  
JZ-66168



Q04  
QUILTING GUIDE  
JZ-66169



RJ-7322LQ4  
HIGH QUILTING FEET  
JZ-66170



Q01  
QUILTING GUIDE  
JZ-66171



Q02  
QUILTING GUIDE  
JZ-66172



PART # 17310  
QUILTING GUIDE  
JZ-66173



7311  
QUILTING GUIDE  
JZ-66174



Q03  
QUILTING GUIDE  
JZ-66175



R1000L  
WALKING FOOT  
JZ-66176



423242-451  
WALKING FOOT  
JZ-66177



421333-451  
SLANT  
JZ-66178



214872011  
WALKING FOOT  
JZ-66179



P60444W  
WALKING FOOT 7MM  
JZ-66180



P60444  
WALKING FOOT  
JZ-66181



YS-7  
ZIGZAG ATTACHMENT  
JZ-66182



RG-10L  
SIDE CUTTER  
JZ-66183



55705  
JZ-66184



55642  
JZ-66185



55642S  
JZ-66186



 RJ-604 缝凸压脚 JZ-66187	 RJ-607 刺绣压脚 JZ-66188	 93-036 941-91 缝凸 pfaff JZ-66189	 98-694 864-00 万能 pfaff JZ-66190	 RJ-7314PW 防水布滚轮压脚 JZ-66191	 93-036 84300 JZ-66192
 98-694 884-00 拉链 pfaff JZ-66193	 98-694 884-00 拉链 pfaff JZ-66194	 RJ-601 ZE 隐形拉链压脚 JZ-66195	 RJ-7315W-1 5-groore 定位压脚 JZ-66196	 93-036 931-91 开口 pfaff JZ-66197	 93-036 931-91 开口 pfaff JZ-66198
 4128649-05 1/4" 拼缝 pfaff JZ-66199	 4128649-06 1/4" 拼缝 弹片靠右 JZ-66200	 98-694 890-00 盲缝 pfaff JZ-66201	 4128451 卷缝 pfaff JZ-66202	 98-694 818-00 卷缝 pfaff JZ-66203	 93-036 982-91 纽扣 pfaff JZ-66204
 98-694 814-00 万能 pfaff JZ-66205	 93-036 933-91 开口 pfaff JZ-66206	 93-036 905-91 万能 pfaff JZ-66207	 98-694 828-01 万能 pfaff JZ-66208	 93-036 936-91 绳索 pfaff JZ-66209	 98-694 845-00 盲缝 pfaff JZ-66210
 4128649-04 1/4" 拼缝弹片置中 JZ-66211	 7318BR 拼布压脚 JZ-66212	 808 绳索压脚 JZ-66213	 7317R 边缝压脚 JZ-66214	 7330 雙边缝凸压脚 JZ-66215	 7301SSW 万能压脚 JZ-66216
 7301J 车乐美万能压脚 JZ-66217	 6705 7-groore定位压脚 JZ-66218	 7308W 7mm 盲缝压脚 JZ-66219	 7301-2J 万能压脚 JZ-66220	 7304W-J 车乐美直线压脚 JZ-66221	 7313W 7mm开口压脚 JZ-66222

 7326JK 定位拼布压脚 JZ-66223	 7313D 饰缝压脚 JZ-66224	 806 万能密缝压脚 JZ-66225	 7310BW-E 布边压脚(E) 7mm JZ-66226	 7318R 边缝压脚 JZ-66227	 7312U 拼布压脚 JZ-66228
 7326BR 盲缝压脚 JZ-66229	 7310BW 7mm 布边压脚 JZ-66230	 7310BW-C 布边压脚 (C) JZ-66231	 6708 定规拼布压脚 JZ-66232	 605 定规饰缝压脚 JZ-66233	 SA538 定规器 JZ-66234
 7327 set 8/8 卷布压脚 JZ-66235	 7327 set 6/8 卷布压脚 JZ-66236	 7327 set 4/8 卷布压脚 JZ-66237	 7329 分离式仓边压脚 JZ-66238	 701J 车乐美刺绣压脚 JZ-66239	 93-036 990-91 纽扣孔 pfaff JZ-66240
 7302PG 纽扣孔压脚 JZ-66241	 7302HPHG 纽扣孔压脚 JZ-66242	 21481720514 Low shank 均匀压脚 JZ-66243	 214806008 High shank 均匀压脚 JZ-66244	 JZ-66251	
 1250001-501 JZ-66245	 1250011-501 JZ-66246	 1250021-501 JZ-66247	 671511-DBC10 JZ-66248	 671511-DDD10 JZ-66249	 JZ-66250



# JINZEN®

JINZEN® 喷枪是一种先进、高效的去污工具。它适用液体的高压喷射，从而达到去污功能。

金振喷枪技术先进，设计合理，喷射压力高，去污能力强，性能稳定，可靠耐用，

是针织、印染、服装、广告、印花等行业完美的去污工具。



JZ-70001



JZ-70021



JZ-70002



JZ-70003



JZ-70004



JZ-70005



JZ-70006



JZ-70007



JZ-70008



JZ-70009



JZ-70020



JZ-70011



JZ-70012



JZ-70013



JZ-70014



JZ-70015



JZ-70016



JZ-70017



JZ-70018



JZ-70019



JZ-70052



JZ-70051



**JINZEN®**

# IRONS





# 电加热熨斗

## STEAM ELECTRIC IRON



2128 JZ-70100



0010 JZ-70101



310 JZ-70103



ES-94A JZ-70104



ES-94AL JZ-70105



ES-85AF JZ-70089



ES-300 JZ-70090



ES-300L JZ-70091



ES-3200 II JZ-70092



SE-2000N JZ-70093



ST-750 JZ-70115



BS-3PC II JZ-70095



BS-6PC II JZ-70096



BS-8SC JZ-70097



BSP-300 JZ-70098



BSS-600 JZ-70099



600 JZ-70106



610 JZ-70107



300 JZ-70108



BSP-200 JZ-70109



6PC JZ-70110



3PC JZ-70111



2A JZ-70112



600A JZ-70113



9000 JZ-70114



# JINZEN® IRONING SHOE 熨斗靴系列



JZ-70281 JZ-70282 JZ-70283 JZ-70284 JZ-70285  
 万能熨斗靴 铁氟龙厚度/TEFION THICKNESS: 6/8/10/12mm



JZ-70250 BD2 JZ-70251 320 JZ-70252 B-6T JZ-70253 HD-2003 JZ-70254 420

STEEL  
 钢网厚度: 6mm  
 TEFION  
 THICKNESS  
 铁氟龙厚度: 3/5/6mm

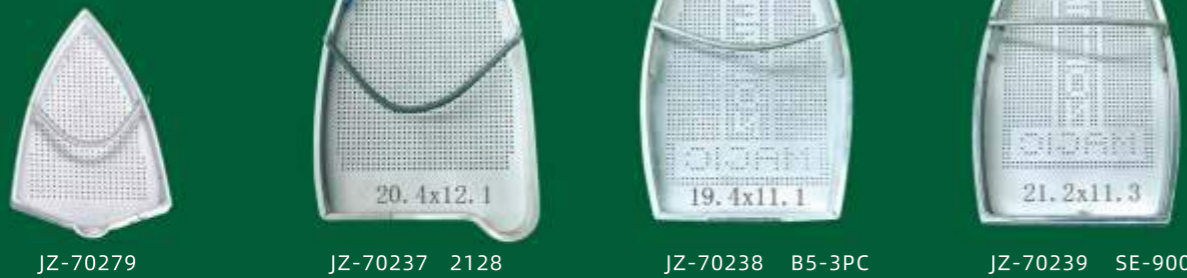

JZ-70279 JZ-70237 2128 JZ-70238 B5-3PC JZ-70239 SE-900

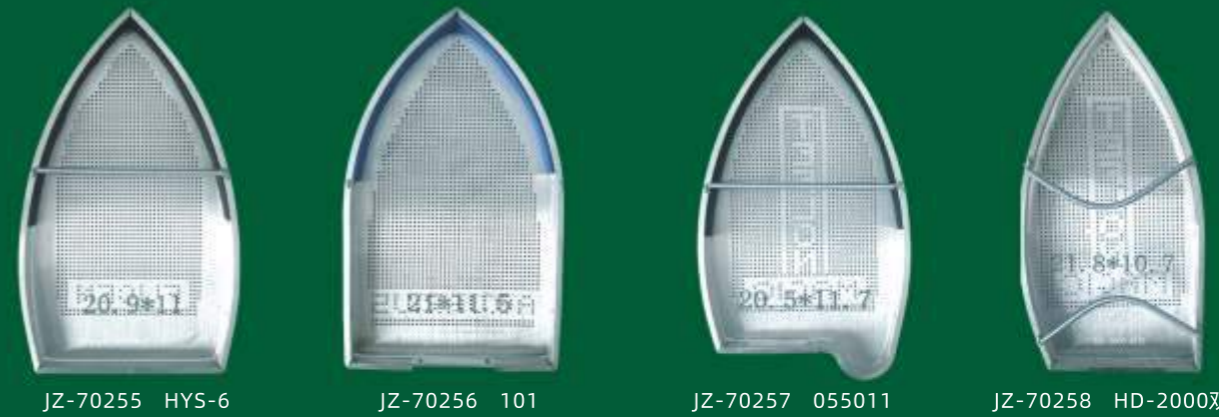

JZ-70255 HYS-6 JZ-70256 101 JZ-70257 055011 JZ-70258 HD-2000双耳



JZ-70240 ES-94A JZ-70241 SA-120 JZ-70243 ASL-600 JZ-70244 ASL-60S



JZ-70259 ES-85AF JZ-70260 60M JZ-70261 50M JZ-70262 SA-110

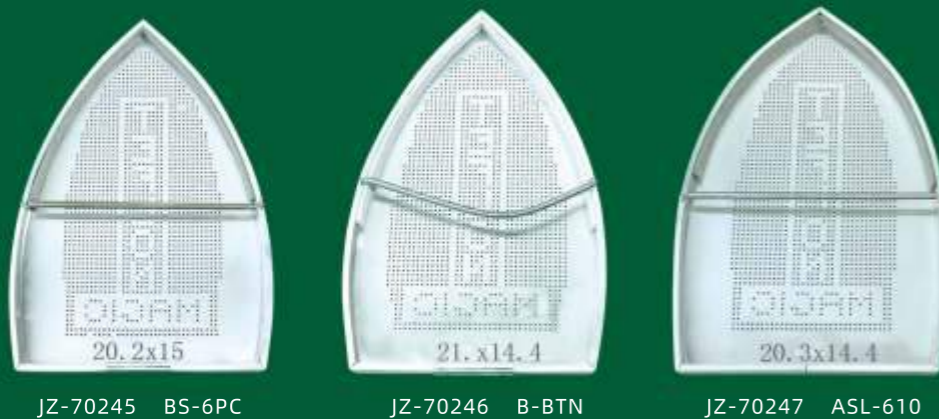

JZ-70245 BS-6PC JZ-70246 B-BTN JZ-70247 ASL-610

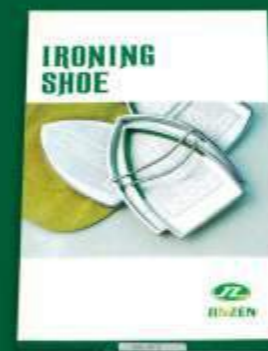

JZ-70263 小600 JZ-70264 300L (100) JZ-70265 STB-200 (BD1) JZ-70266 101



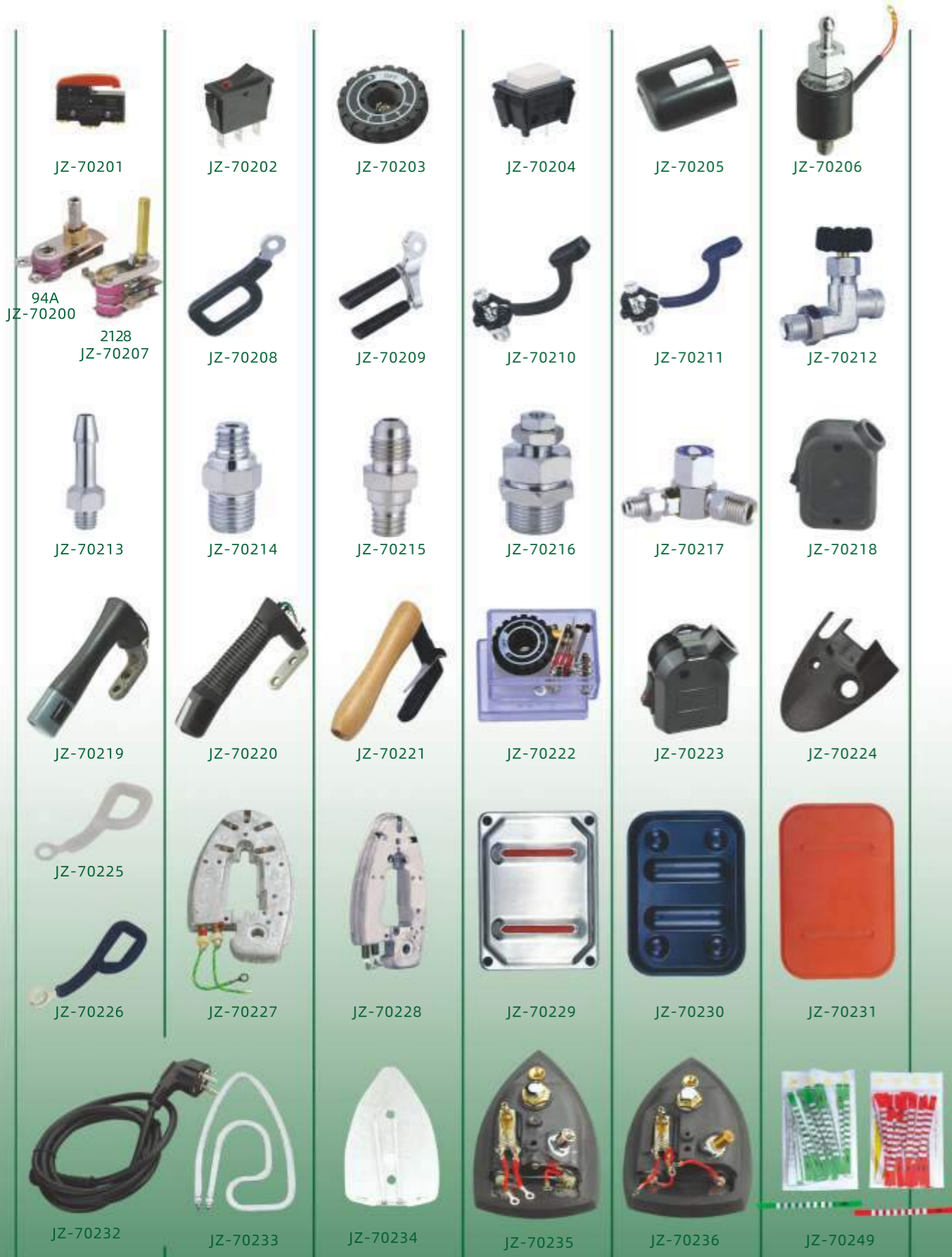



**ES-85AF**

JZ-70151

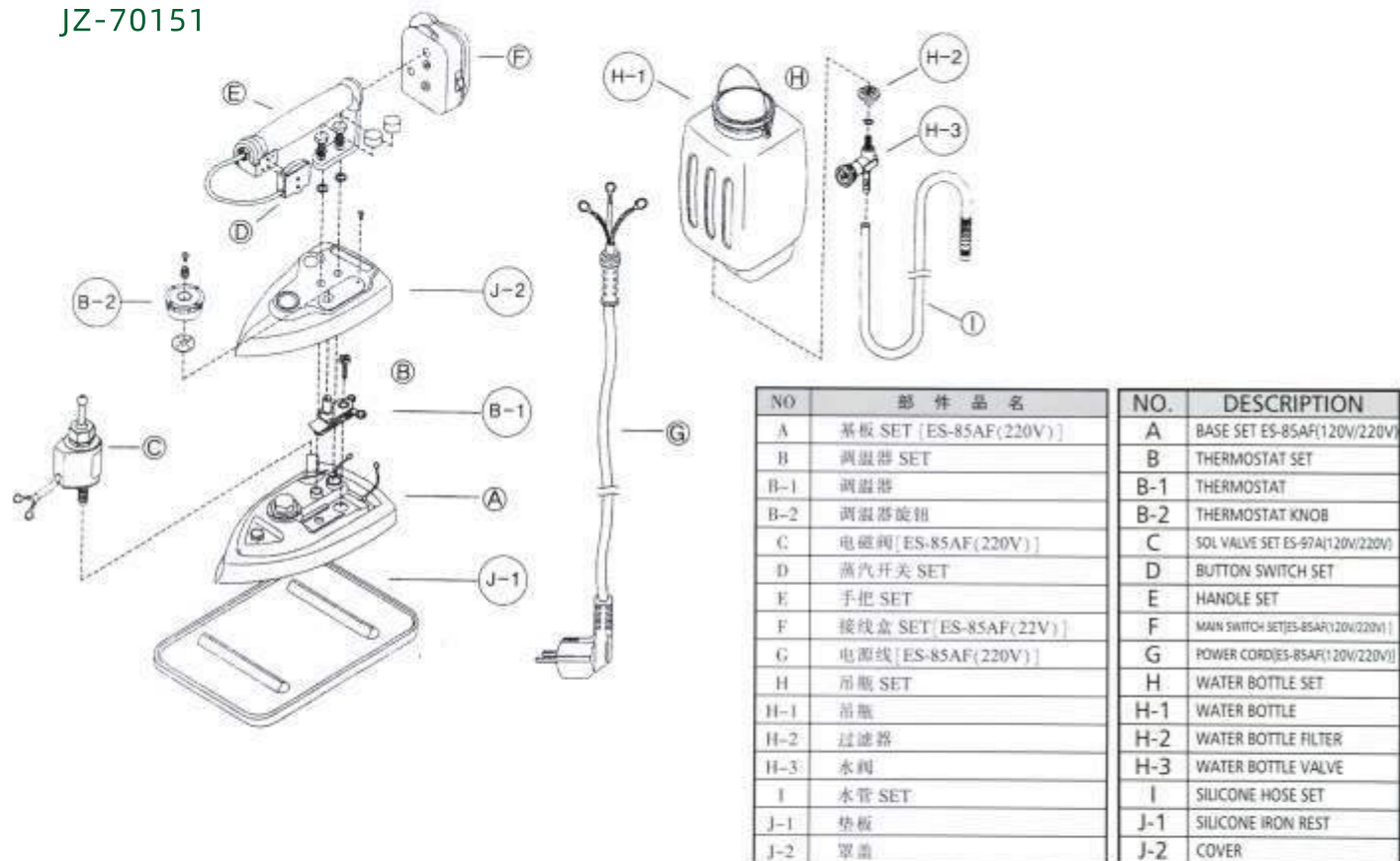

**ES-94A/ES-94AL**

JZ-70153

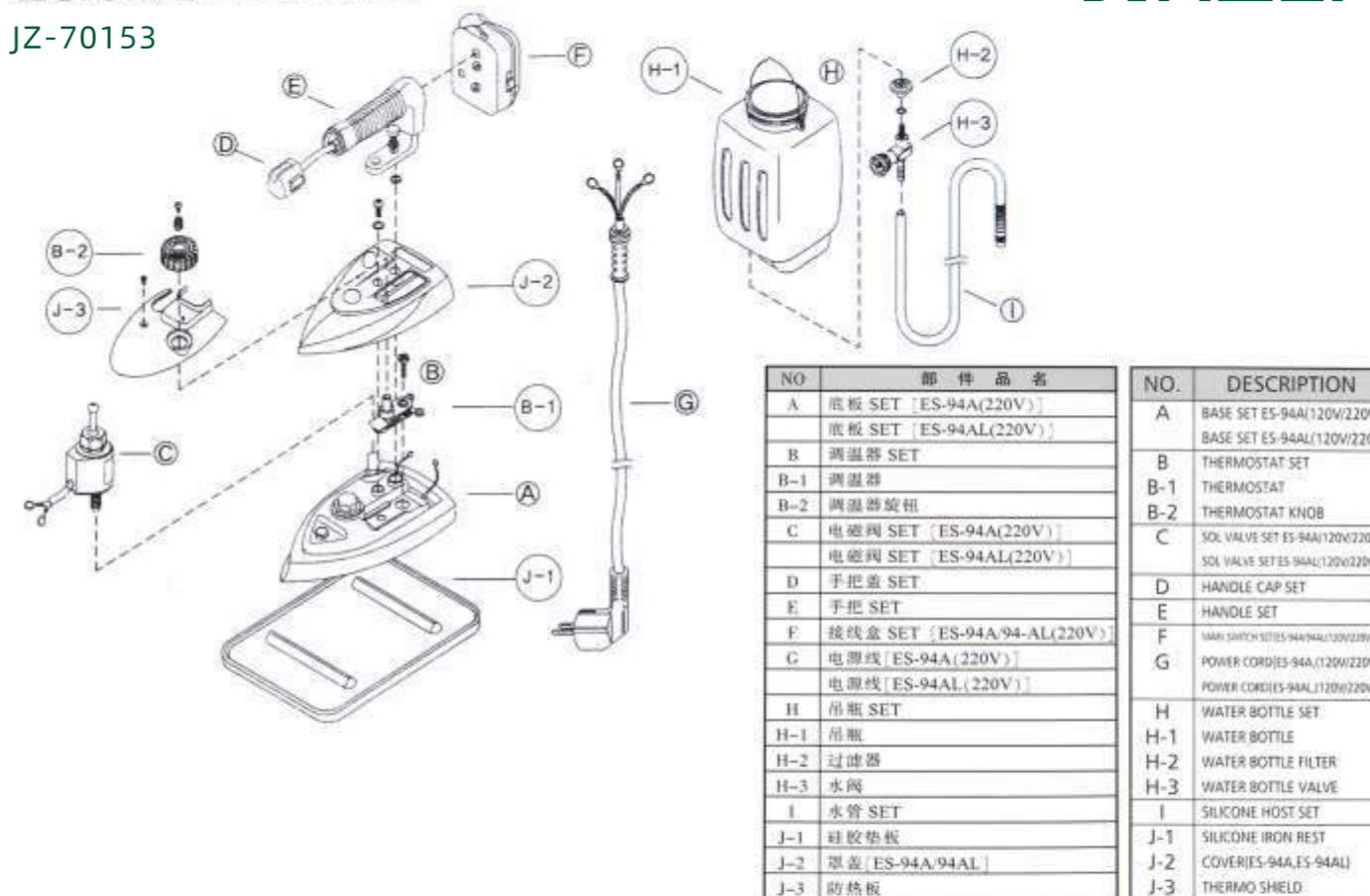

**ES-90A**

JZ-70152

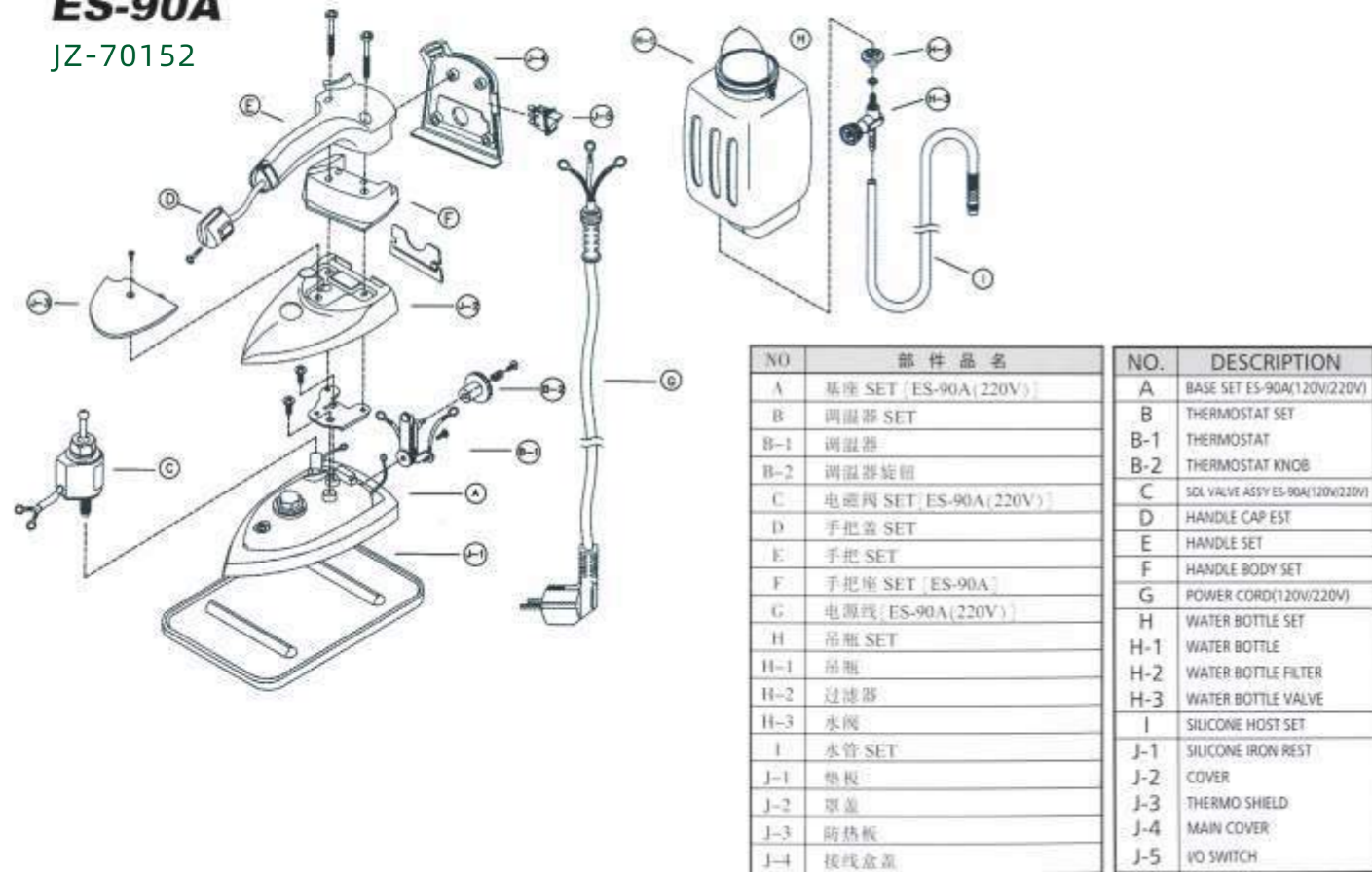

**ES-97A**

JZ-70154

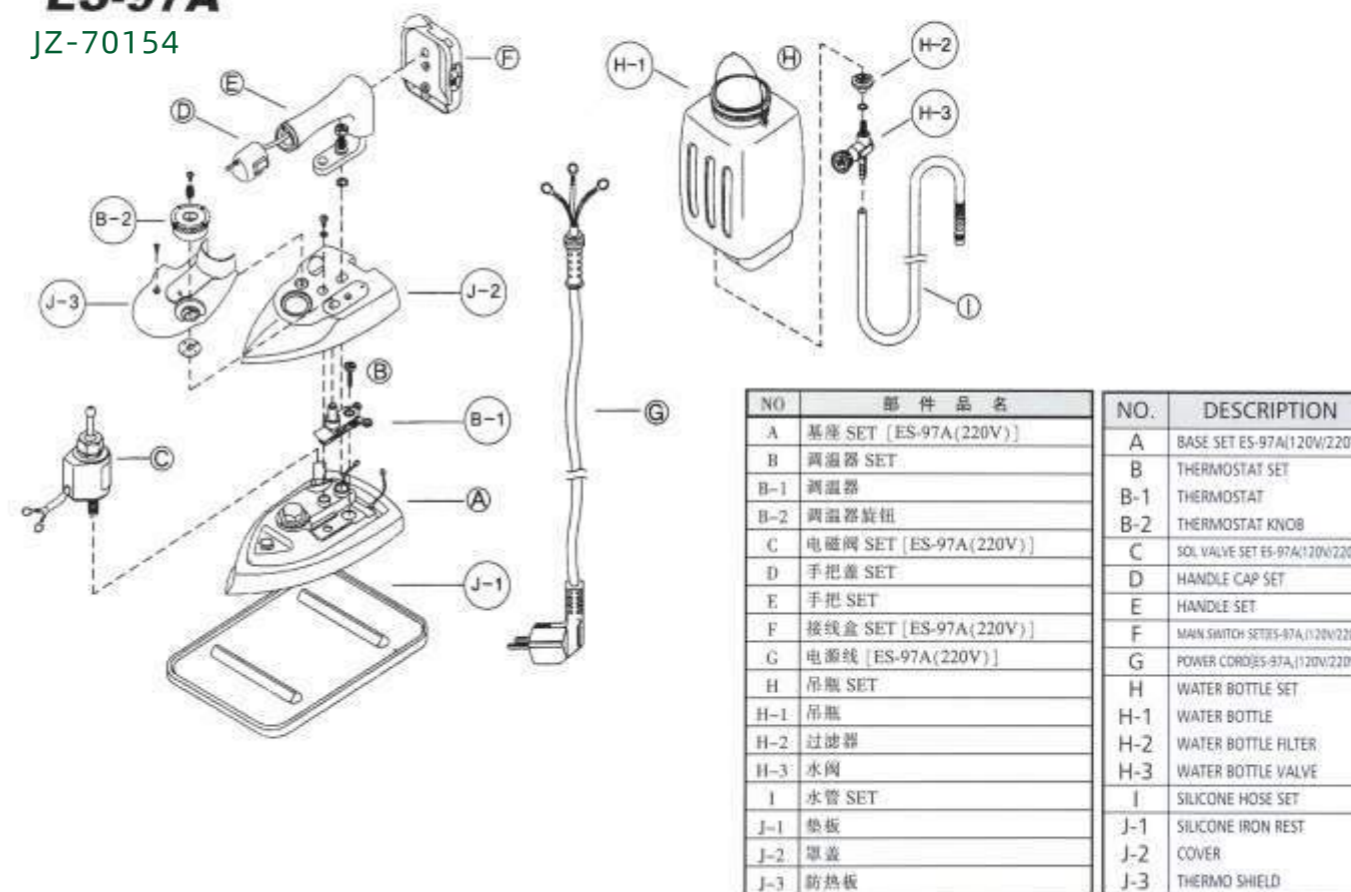



# ES-300/ES-300L

JZ-70155

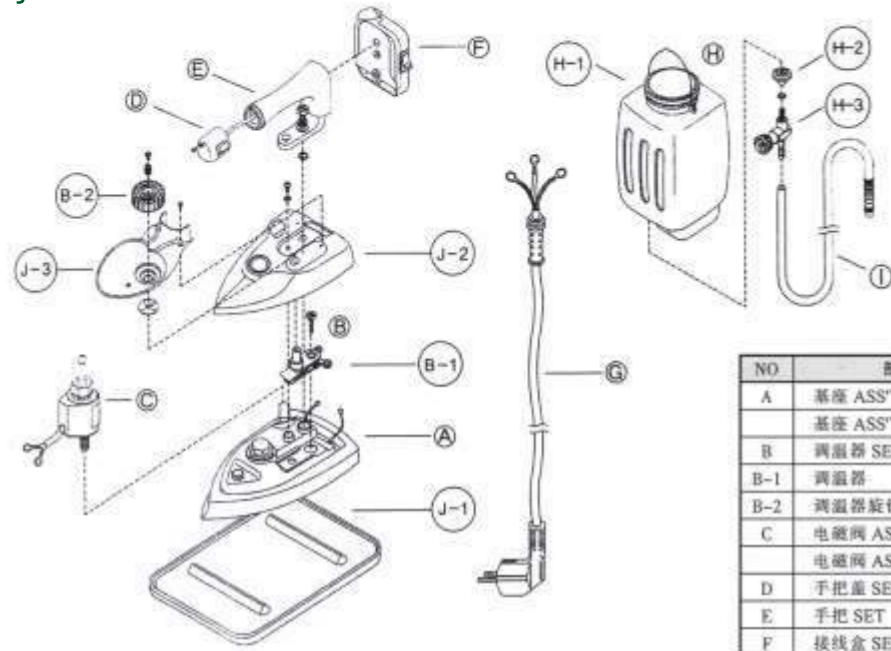

NO.	部 件 品 名	NO.	DESCRIPTION
A	底座 ASS'Y [ES-300(220V)]	A	BASE ASSY ES-300(120V/220V)
	底座 ASS'Y [ES-300L(220V)]		BASE ASSY ES-300L(120V/220V)
B	调温器 SET	B	THERMOSTAT SET
B-1	调温器	B-1	THERMOSTAT
B-2	调温器旋钮	B-2	THERMOSTAT KNOB
C	电磁阀 ASS'Y [ES-300(220V)]	C	SOL VALVE ASSY ES-300(120V/220V)
	电磁阀 ASS'Y [ES-300L(220V)]		SOL VALVE ASSY ES-300L(120V/220V)
D	手柄盖 SET	D	HANDLE CAP SET
E	手柄 SET	E	HANDLE SET
F	接线盒 SET [ES-300(220V)]	F	MAIN SWITCH SETES-300(120V/220V)
	接线盒 SET [ES-300L(220V)]		MAIN SWITCH SETES-300L(120V/220V)
G	电源线 [ES-300(220V)]	G	POWER CORD[ES-300(120V/220V)]
	电源线 [ES300L(220V)]		POWER CORD[ES-300L(120V/220V)]
H	吊瓶 SET	H	WATER BOTTLE SET
H-1	吊瓶	H-1	WATER BOTTLE
H-2	过滤器	H-2	WATER BOTTLE FILTER
H-3	水阀	H-3	WATER BOTTLE VALVE
I	水管	I	SILICONE HOSE SET
J-1	物板	J-1	SILICONE IRON SET ES-300/300L
J-2	罩盖 [ES-300/300L]	J-2	COVER[ES-300/300L]
J-3	防热板	J-3	THERMO SHIELD

# SE-2000N

JZ-70157

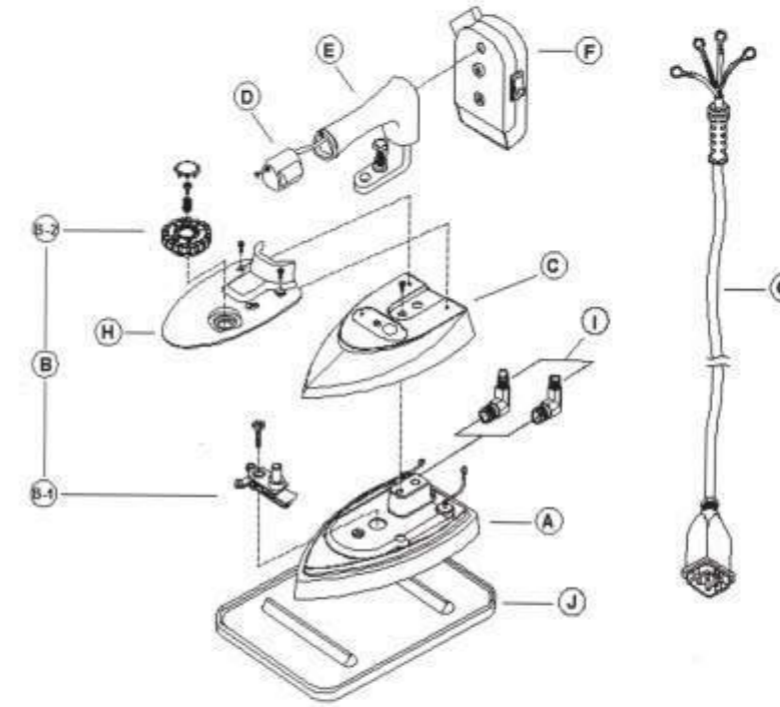

NO.	配件名称
A	底座套 [220V/1000W]
B	调温器套
B-1	调温器
B-2	调温器旋钮
C	罩盖
D	手柄盖套
E	手柄套
F	接线盒套
G	电源线套 [4芯]
H	防热板
I	管接头 [C/E 型]
J	垫板 [中]

# ES-3200N II

JZ-70156

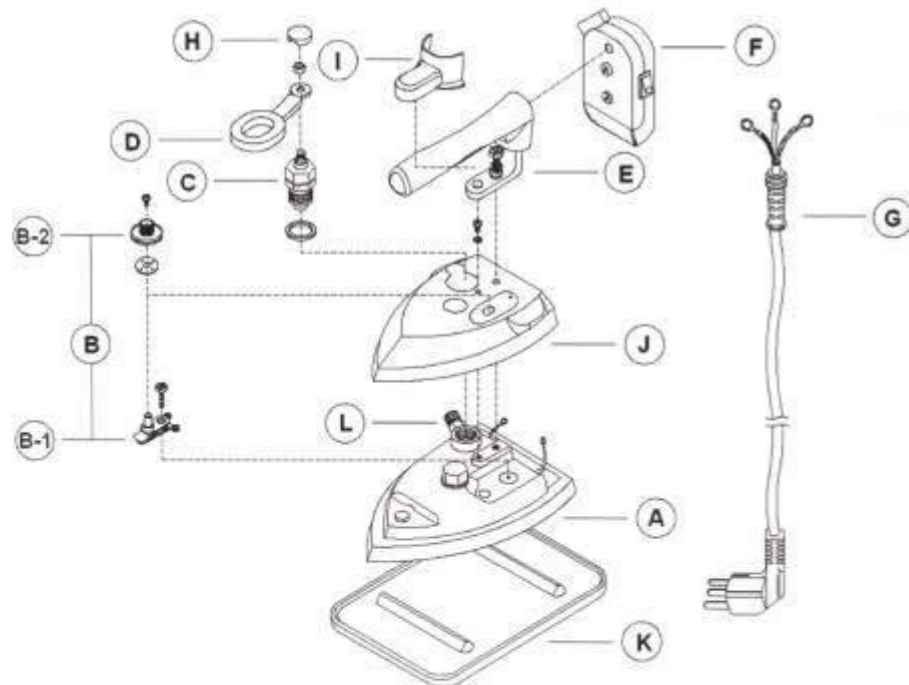

NO.	PARTS NAME
A	BASE SET[120V/220V]
B	THERMOSTAT SET
B-1	THERMOSTAT
B-2	THERMOSTAT KNOB
C	STEAM VALVE[SWING]
D	VALVE LEVER[SWING]
E	HANDLE SET
F	MAIN SWITCH SET
G	POWER CORD[120V/220V]
H	STEAM VALVE CAP
I	HANDLE BRACKET CAP
J	COVER
K	SILICONE IRON REST
L	NIPPLE[C/E TYPE]

# BS-8SC

JZ-70170

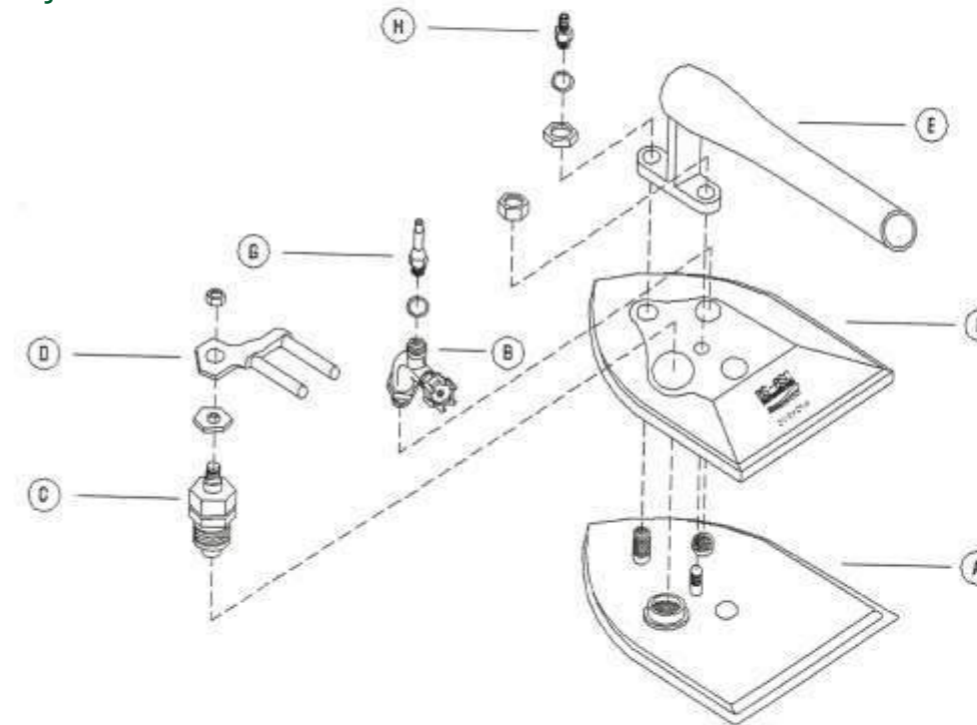

NO.	PARTS NAME
A	BASE[BS-8SC]
B	EXIT VALVE
C	STEAM VALVE[SWING TYPE]
D	VALVE LEVER[SWING TYPE]
E	HANDLE SET
F	COVER
G	NIPPLE[A]
H	NIPPLE[C]



**BS-3PC** JZ-70171

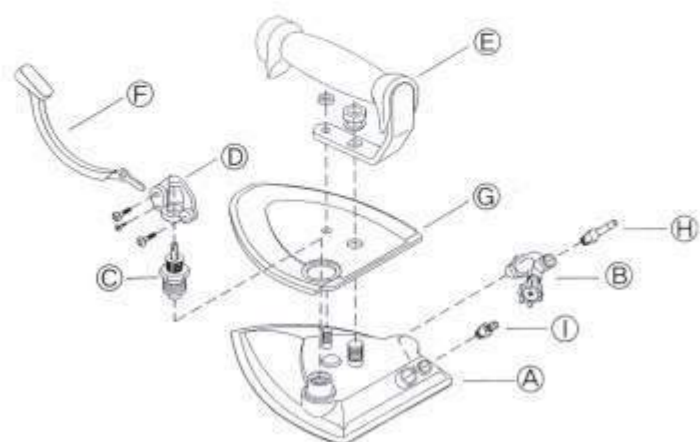

NO	部件品名	NO.	DESCRIPTION
A	底座	A	BASE
B	回汽阀	B	EXIT VALVE SET
C	气阀	C	STEAM VALVE SET
D	气阀架	D	VALVE BAND SET
E	手柄	E	HANDLE SET
F	气阀手柄	F	VALVE LEVER
G	罩盖	G	COVER
H	回气接头(E)	H	NIPPLE (A)
I	进汽接头	I	NIPPLE (C)

**BSP-200** JZ-70174

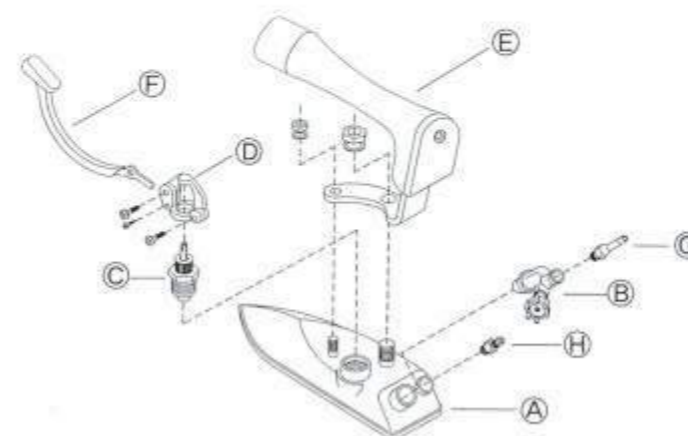

NO	部件品名	NO.	DESCRIPTION
A	底座	A	BASE
B	回汽阀	B	EXIT VALVE SET
C	气阀	C	STEAM VALVE SET
D	气阀架	D	VALVE BAND SET
E	手柄	E	HANDLE SET
F	气阀手柄	F	VALVE LEVER
G	回气接头(E)	G	NIPPLE (A)
H	进汽接头	H	NIPPLE (C)

**BS-6PC** JZ-70172

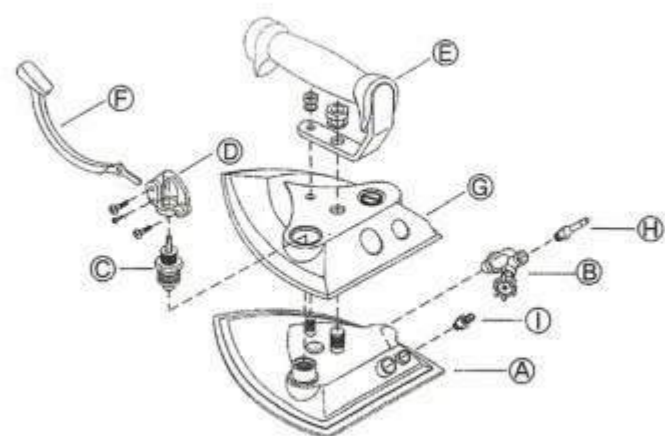

NO	部件品名	NO.	DESCRIPTION
A	底座	A	BASE
B	回汽阀	B	EXIT VALVE SET
C	气阀	C	STEAM VALVE SET
D	气阀架	D	VALVE BAND SET
E	手柄	E	HANDLE SET
F	气阀手柄	F	VALVE LEVER
G	罩盖	G	COVER
H	回气接头(E)	H	NIPPLE (A)
I	进汽接头	I	NIPPLE (C)

**BSP-300** JZ-70175

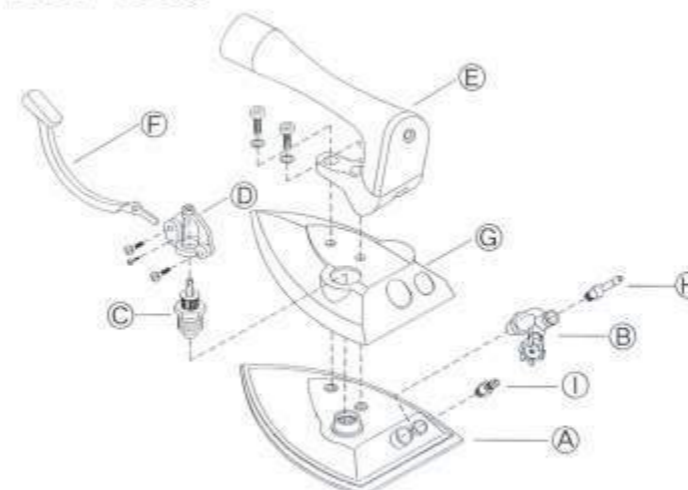

NO	部件品名	NO.	DESCRIPTION
A	底座	A	BASE
B	回汽阀	B	EXIT VALVE SET
C	气阀	C	STEAM VALVE SET
D	气阀架	D	VALVE BAND SET
E	手柄	E	HANDLE SET
F	气阀手柄	F	VALVE LEVER
G	罩盖	G	COVER
H	回气接头(E)	H	NIPPLE (A)
I	进汽接头	I	NIPPLE (C)

**BSS-600** JZ-70173

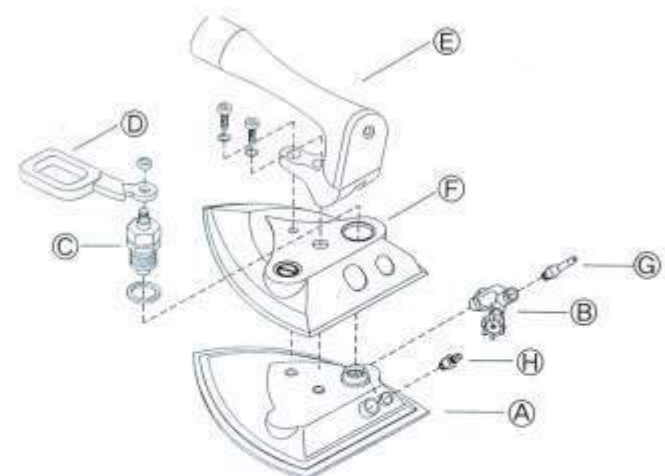

NO	部件品名	NO.	DESCRIPTION
A	底座	A	BASE
B	回汽阀	B	EXIT VALVE SET
C	气阀	C	STEAM VALVE SET
D	气阀手柄	D	VALVE LEVER
E	手柄	E	HANDLE SET
F	罩盖	F	COVER
G	回气接头(E)	G	NIPPLE (A)
H	进汽接头	H	NIPPLE (C)

**BSP-600** JZ-70176

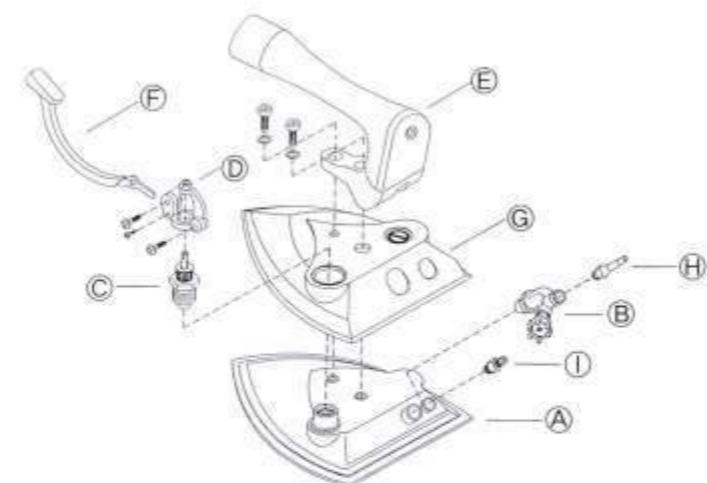

NO	部件品名	NO.	DESCRIPTION
A	底座	A	BASE
B	回汽阀	B	EXIT VALVE SET
C	气阀	C	STEAM VALVE SET
D	气阀架	D	VALVE BAND SET
E	手柄	E	HANDLE SET
F	气阀手柄	F	VALVE LEVER
G	罩盖	G	COVER
H	回气接头(E)	H	NIPPLE (A)
I	进汽接头	I	NIPPLE (C)



# JINZEN®

## 衣车油漆 PAINT FOR SEWING MACHINE



色标 COLOR SAMPLE	编号 PARTS NO.	适用车型 SUITABLE MACHINE	油漆类别 PAINT STYLE
	JZ-70401	祖奇 平车 JUKI DDL-555	锤纹喷漆 HAMMER FINISH PAINT
	JZ-70402	祖奇 平车 JUKI DDL-5550	自动喷漆(平纹) IN/EX SPRAY PAINT
	JZ-70403	祖奇 双针车 JUKI LH-515	锤纹喷漆 HAMMER FINISH PAINT
	JZ-70404	兄弟 平车 BROTHER DB2-B735	锤纹喷漆 HAMMER FINISH PAINT
	JZ-70405	兄弟 平车 BROTHER DB2-B755	锤纹喷漆 HAMMER FINISH PAINT
	JZ-70406	雅满桃 多针环 缝车 YAMATO Vf2500	自动喷漆(平纹) IN/EX SPRAY PAINT
	JZ-70407	于仁 埋夹车 (旧款) UNION SPECIAL 35800(OLD)	锤纹喷漆 HAMMER FINISH PAINT
	JZ-70408	银箭 包缝车 SIRUBA 747	自动喷漆(平纹) IN/EX SPRAY PAINT
	JZ-70409	雅满桃 多针环 缝车 YAMATO DW-1500	锤纹喷漆 HAMMER FINISH PAINT
	JZ-70410	真善美 平车 JANOME 706	锤纹喷漆 HAMMER FINISH PAINT
	JZ-70411	于仁 埋夹车 (新款) UNION SPECIAL 35800(NEW)	自动喷漆(平纹) IN/EX SPRAY PAINT
	JZ-70412	利是 凤眼车 REECE 101	自动喷漆(平纹) IN/EX SPRAY PAINT

# TAGGING GUN

\* 全新设计，解决了以往吊牌枪固定齿轮掉牙和固定钩子易磨损，本枪使用不锈钢钩子和伸缩弹簧钩，在插入胶针时会自动退缩，拔出胶针时按箭头所示向后扳，再拔胶针，不会磨损钩子，延长使用时间。





# JINZEN®

## GUN NEEDLE



JZ-70601  
202



S标准枪针(B)  
S standard needle(B)

JZ-70602  
S-38 刀针



S标准刀针  
S standard needle

JZ-70603  
203 细针



X细枪针  
X fine needle

JZ-70604  
204 长针



L长枪针  
L long needle

JZ-70605  
205 细长针



XL细长枪针  
XL fine long needle

JZ-70606  
203 刀针



标准刀枪针  
Standard cut needle

JZ-70607  
203 细刀针



细刀枪针  
Fine cut needle

JZ-70608  
106 塑料刀针



塑料柄标准刀枪针  
Plastic head standard cut needle

JZ-70609



塑料柄长刀枪针  
Plastic head long cut needle

JZ-70610  
X-30 塑料细刀针



塑料柄细刀枪针  
Plastic head fine cut needle

## STANDARD PIN

因为用心,所以专业  
BECAUSE THE HEART, SO PROFESSIONAL

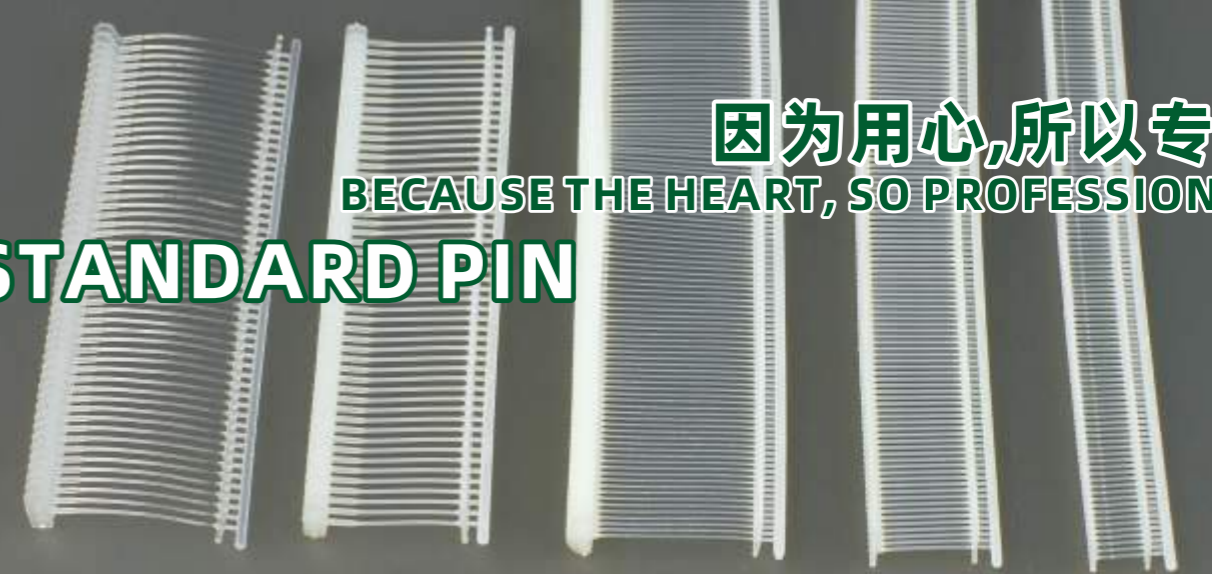

### JZ-70651

5mm PP	25mm PP
7mm PP	35mm PP
8mm PP	50mm PP
9mm PP	65mm PP
10mm PP	75mm PP
12mm PP	100mm PP
15mm PP	125mm PP

### JZ-70652

5mm NYLON	25mm NYLON
7mm NYLON	35mm NYLON
8mm NYLON	50mm NYLON
9mm NYLON	65mm NYLON
10mm NYLON	75mm NYLON
12mm NYLON	100mm NYLON
15mm NYLON	125mm NYLON



### JZ-70653 问字钩 HOOK PIN

HP 35 PP  
HP 50 PP  
HP 65 PP



### JZ-70654 圆字勾 RING PIN

RP 35 PP  
RP 50 PP  
RP 65 PP



### JZ-70655 双排钉 DOUBLE PINS

DP 35 PP  
DP 50 PP  
DP 65 PP  
DP 75 PP



### JZ-70656 吊环 LOOP PINS

LP- 3 inch  
LP- 5 inch  
LP- 7 inch  
LP- 9 inch  
LP-12inch  
LP-16inch  
LP-18inch



### JZ-70657 吊环 LOOP PINS

LP- 3 inch  
LP- 5 inch  
LP- 7 inch  
LP- 9 inch



### JZ-70658 吊环 LOOP PINS

LP- 3 inch  
LP- 5 inch  
LP- 7 inch  
LP- 9 inch



### JZ-70659 吊环 LOOP PINS

LP- 3 inch  
LP- 5 inch  
LP- 7 inch  
LP- 9 inch



JZ-70721-AAAAA 8" 9" 10" 11" 12"



## JINZEN®

我们要做同行中的领跑者，创造美好品质、赋予贴心服务。

我们时刻要以严谨，高效，负责任的工作态度来要求自己，

使金振系列产品多元化，品质国际化，满意全球市场，更好的服务全球每一个客户。

We do the leader in the line, create a better quality,

and gives intimate service. We are always in strict,

efficient and responsible work attitude to demands on ourselves,

so that JINZEN products will be diversification, quality-internationalization,

satisfaction with the global market and better to serve every customer in the world.



JZ-70721-AAA

8" 9" 10" 11" 12"



JZ-70730-AAA

8" 9" 10" 11" 12"



JINZEN®



JZ-70731

JZ-70714



JZ-70700

JZ-70701

JZ-70702

JZ-70691  
不锈钢 STEEL

JZ-70704

JZ-70705

JZ-70706

JZ-70707

JZ-70708

台湾品质  
Taiwan quality

JZ-70713

台湾品质  
Taiwan quality

JZ-70712

JZ-70696

JZ-70694

JZ-70698

JZ-70693

JZ-70692

JZ-70692-A

JZ-70699  
不锈钢 STEEL





JZ-70738 A3

JZ-70739-AAAAAJP202

JZ-70740AAA P01

JZ-70741  
电加热



JZ-70720 1#



JZ-70720 2#



JZ-70720 3#



JZ-70725



JZ-70716



JZ-70722



JZ-70723



JZ-70742 平头



JZ-70743 平头



JZ-70744



JZ-70733  
不锈钢 STEEL



JZ-70728



JZ-70727



JZ-70729



JZ-70734



JZ-70715 9"  
不锈钢 STEEL



JZ-70715 10"  
不锈钢 STEEL



JZ-70735  
不锈钢 STEEL



JZ-70736  
不锈钢 STEEL



JZ-70737  
不锈钢 STEEL



# 卓越品质 源自台湾

EXCELLENT QUALITY ORIGINAL TAIWAN

通过CE认证  
Lights have obtained  
CE certificate.

# JINZEN®



JZ-70831

JZ-70830

## NEW FEATURES

- ◎ Built-in reflection film to increase brightness.
- ◎ Acrylic cover to protect LED from dust/oil.
- ◎ Good quality PCB, and with small holes at the back of the lamp head, easy heat radiating.
- ◎ "G" clamp can be 4CM maximum.

## 產品特性

- ◎ 燈頭裏面使用納米反光膜,使亮度更好!
- ◎ 燈頭採用亞克力燈罩,防塵防油設計,可避免油對燈珠的腐蝕損壞,外觀大氣。
- ◎ 燈頭後面有四個小型出氣孔,且採用了鋁合金燈板,可防止燈珠過熱而造成的亮度衰減。
- ◎ 加厚的G型夾,張開距離為4CM。

可選擇聯線方式(Optional connection)



CHINESE CCC PLUGS  
中國CCC標準插頭

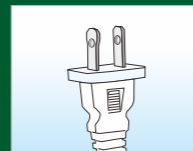

UL/CSA (C-UL) PLUGS  
美國/加拿大標準插頭



GERMANY VDE PLUGS  
德國VDE標準插頭

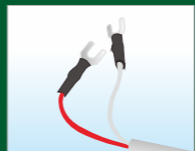

Motor Switch  
馬達開關聯接

## 磁吸系列 Magnetic Series

方便快捷, 高效率  
Convenient,  
high efficiency



(Brightness can be daylight or purple)  
白光/紫光可切换  
Applicable to leather machinery  
箱包皮鞋厂专用





# JINZEN LED工作灯 SEWING MACHINE LED LIGHT,

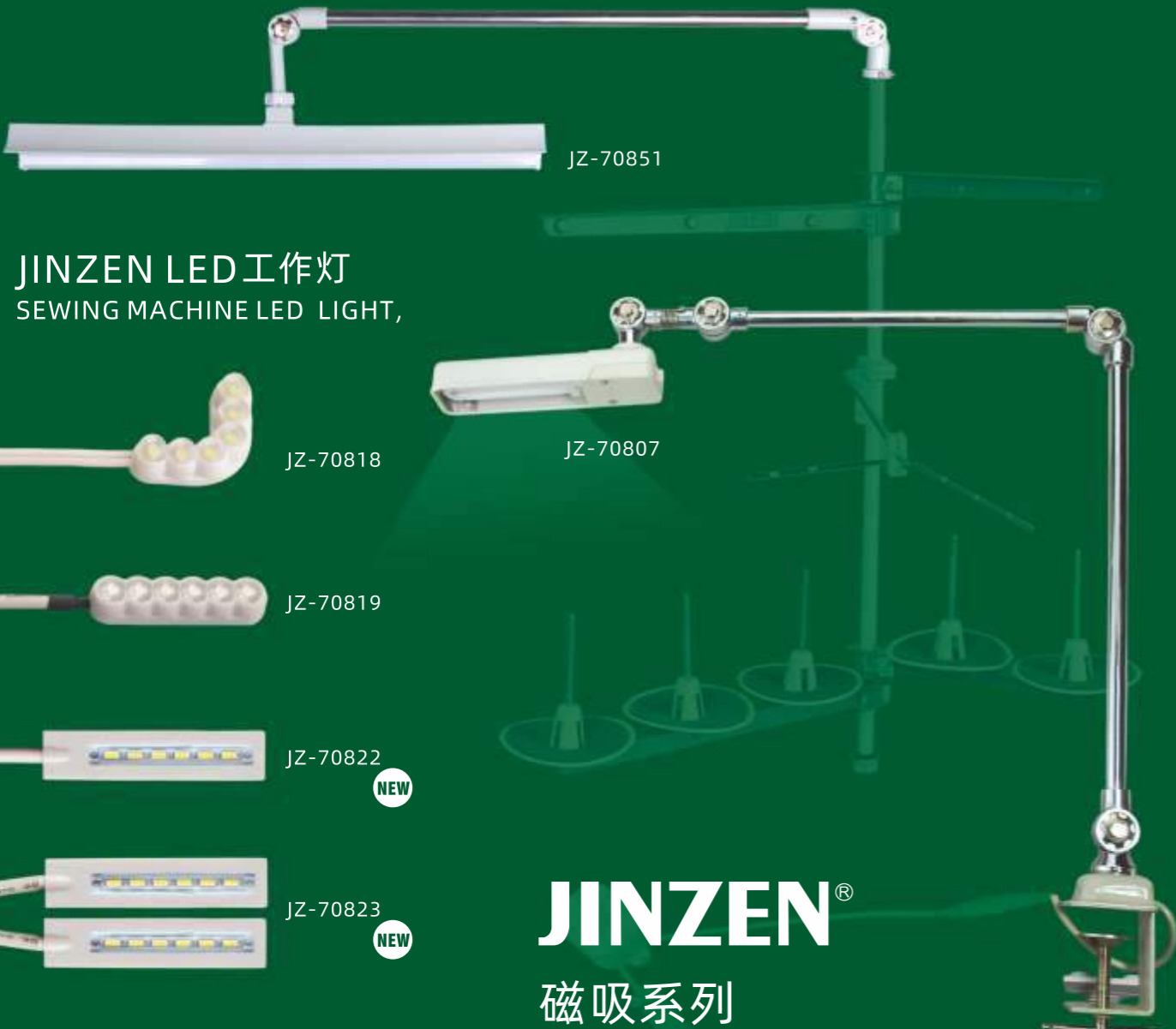

## JINZEN® 磁吸系列 Magnetic Series

可選擇聯線方式(Optional connection)



DC3 5 Terminal  
DC3 5端子 (3V)

EL Terminal  
EL 端子 (3V)

Motor Switch  
馬達開關連接

方便快捷，高效率  
Convenient,  
high efficiency

LED數量/LED Amount	2Pcs/6Pcs/10Pcs/12Pcs
功率/Power	0.5W/1W/5W
頻率/Frequency	50HZ/60HZ
輸出電流(DC) /Output current (DC)	120mA/60mA /40mA
色溫/Color temperature	6000-6500K
壽命/Lifespan	50000H
工作環境溫度/Environment temperature	-40+50°C
額定電壓/Rated Voltage	AC110-250V/ AC380V
固定方式/Fixed mode	高性能磁鐵 Magnet / 螺絲固定Screw
接線/Link	馬達開關 Motor Switch / 電控箱 Electric Cabinet 可選擇聯線方式 Optional connection

- JZ-70818
- JZ-70819
- JZ-70822 **NEW**
- JZ-70823 **NEW**
- JZ-70824 **NEW**
- JZ-70826 **NEW**

- JZ-70852
- JZ-70853
- JZ-70854
- JZ-70855
- JZ-70856
- JZ-70857
- JZ-70858

- NEW** JZ-70841 BRIGHTNESS 3TIMES  
适用于包缝机  
For overlock
- NEW** JZ-70842  
For SIRUBA 988
- NEW** JZ-70843
- NEW** JZ-70844  
电脑车用倒缝开关
- NEW** JZ-70827  
(标准牌電腦平缝機專用)  
Typical computerized single needle lockstitch sewing machine

卓越品质 源自台湾  
EXCELLENT QUALITY ORIGINAL TAIWAN







# 验布器 CLOTH INSPECTOR

JZ-70900



JZ-70900



JZ-70901



JZ-70904



JZ-70902



可调解



JZ-70903



JZ-70913



JZ-70914

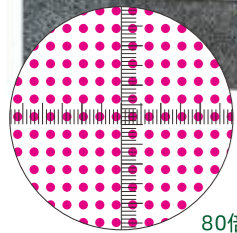

80倍

## 激光定位器 (Laser Light Positioner)



JZ-70915  
(点状)/(Point)



JZ-70916  
(直线)/(Line)



JZ-70917  
(十字)/(Cross)

## 激光标线器 (镭射标线器)

激光标线器可广泛用于各种裁床机制布定位、放线。  
能产生一字和十字清晰明亮的红线、体积小、方便调节、易于安装、  
稳定可靠。能较大幅度的提高工作效率。  
我们还可以提供电源内置一体式镭射标线器，使客户的使用更加方便。

The equipment is wide applies to various cloth localization cutting machine,  
collimated package machine. It can emit a clear bright red line like one and ten,  
and has small body with easy adjustd. It is also easy to set up and also safe stability.  
It can improve working efficiency highly. we can offer a unity series laser  
marking-off equipment with power supply inside for easier using.



JZ-70905 360度 DEGREES



JZ-70906 RED  
(点状)/(Point)

JZ-70907 RED  
(直线)/(Line)

JZ-70908 RED  
(十字)/(Cross)



## 激光标线器 (镭射标线器)



JZ-70911 GREEN  
(直线)/(Line)

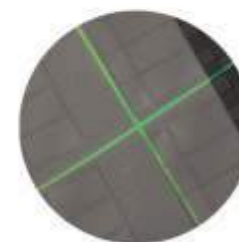

JZ-70912 GREEN  
(十字)/(Cross)



JINZEN®



JZ-70920 JZ-70921 JZ-70922 JZ-70923



JZ-70924 JZ-70925 JZ-70926 JZ-70927

## Multifunctional Toolkit 多功能工具包



JZ-70918





◆ 高温消色笔



JZ-70971  
JZ-70972  
JZ-70973  
JZ-70974  
JZ-70975

◆ 皮革水银笔

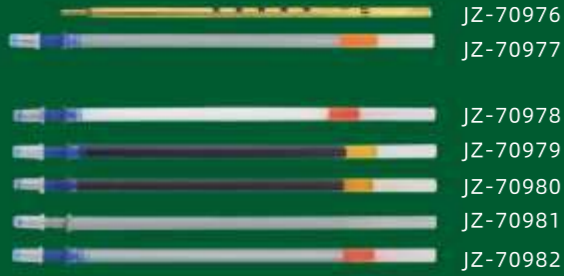

JZ-70976  
JZ-70977  
JZ-70978  
JZ-70979  
JZ-70980  
JZ-70981  
JZ-70982

◆ 高温消色笔 (细)



JZ-70983  
JZ-70984  
JZ-70985  
JZ-70986  
JZ-70987



JZ-70988  
JZ-70989



JZ-70990  
JZ-70991



JZ-70992  
JZ-70993

◆ 无痕皮革高温消失笔

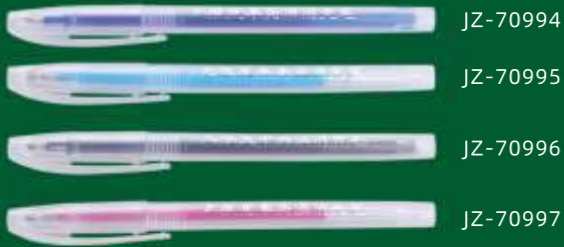

JZ-70994  
JZ-70995  
JZ-70996  
JZ-70997

◆ 水银清洗笔



JZ-70998  
JZ-70999

大容量水银笔



JZ-71000  
JZ-71002  
JZ-71003  
JZ-71004  
JZ-71005  
JZ-71006  
JZ-71007

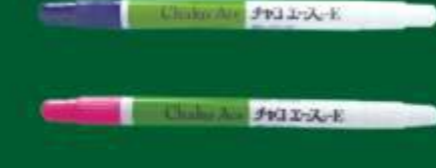

JZ-71008  
JZ-71009



JZ-71010  
JZ-71011



JZ-71012  
JZ-71013



JZ-71014  
JZ-71015



JZ-71016



JZ-71020 JZ-71021



JZ-71019 JZ-70970



JZ-71100 TWE 7 JZ-71101 TWE 8 JZ-71102 TWE 6 with teeth JZ-71023 JZ-71024 JZ-71107 JZ-71108



JZ-71037 JZ-71038 JZ-71098 JZ-71039 JZ-71040 JZ-71099 JZ-71025 JZ-71026



JZ-71035 JZ-71027 JZ-71028 JZ-71029 JZ-71032 JZ-71033 JZ-71034



JZ-71030A JZ-71030B JZ-71030E JZ-71030 JZ-71031





JZ-71133S

JZ-71133L

**JINZEN**®



JZ-71130

JZ-71131

JZ-71132

JZ-71134

JZ-71137

JZ-71138

JZ-71139

JZ-71141  
1.5/3/5/7KG

JZ-71091  
纺织纱剪

JZ-71041

JZ-71042

JZ-71043

JZ-71044

JZ-71045

JZ-71046

JZ-71048

JZ-71047

JZ-71049

JZ-71050

JZ-71051

JZ-71092

JZ-71093

JZ-71094

JZ-71095

模板机附件

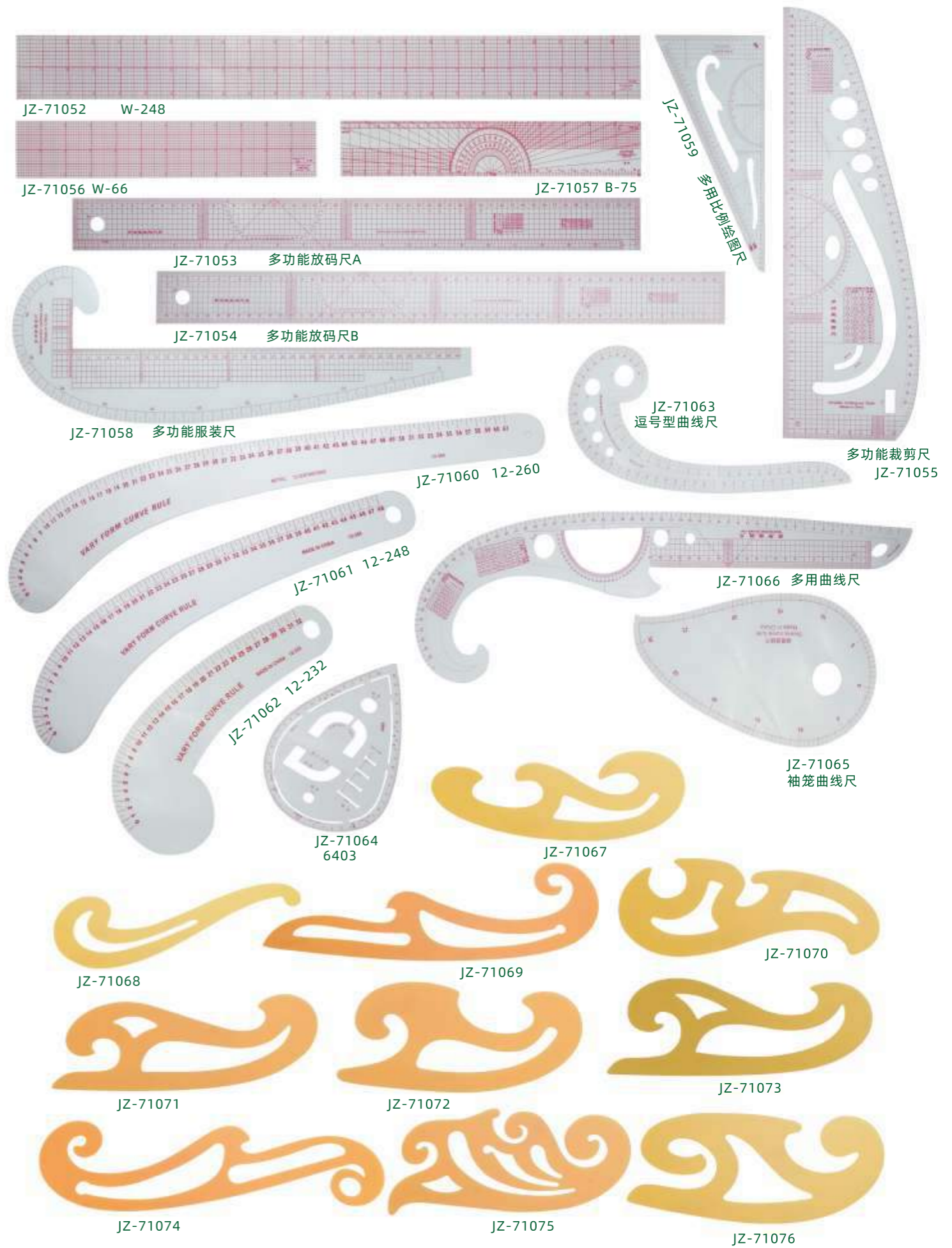

JZ-71052 W-248

JZ-71056 W-66

JZ-71057 B-75

JZ-71053 多功能放码尺A

JZ-71054 多功能放码尺B

JZ-71059 多用比例绘图尺

JZ-71058 多功能服装尺

JZ-71063 逗号型曲线尺

多功能裁剪尺  
JZ-71055

JZ-71060 12-260

JZ-71061 12-248

JZ-71066 多用曲线尺

JZ-71062 12-232

JZ-71064  
6403

JZ-71067

JZ-71065 袖笼曲线尺

JZ-71068

JZ-71069

JZ-71070

JZ-71071

JZ-71072

JZ-71073

JZ-71074

JZ-71075

JZ-71076





JZ-71201



JZ-71202



JZ-71207



JZ-71203



JZ-71204



JZ-71205



JZ-71206



JZ-71352



JZ-71353



JZ-71208



JZ-71301



JZ-71302



JZ-71303



JZ-71304



JZ-71312



JZ-71209

JZ-71210



JZ-71305

JZ-71307

JZ-71308



JZ-71350



JZ-71351



JZ-71309



JZ-71310



JZ-71311



JZ-71313



## 卓越新品

金振精工螺丝刀采用优质钢材，硬度高，不易折。  
金振精工螺丝刀您的信赖之选。



JZ-71333

JZ-71334

JZ-71335

JZ-71336

JZ-71337

JZ-71338

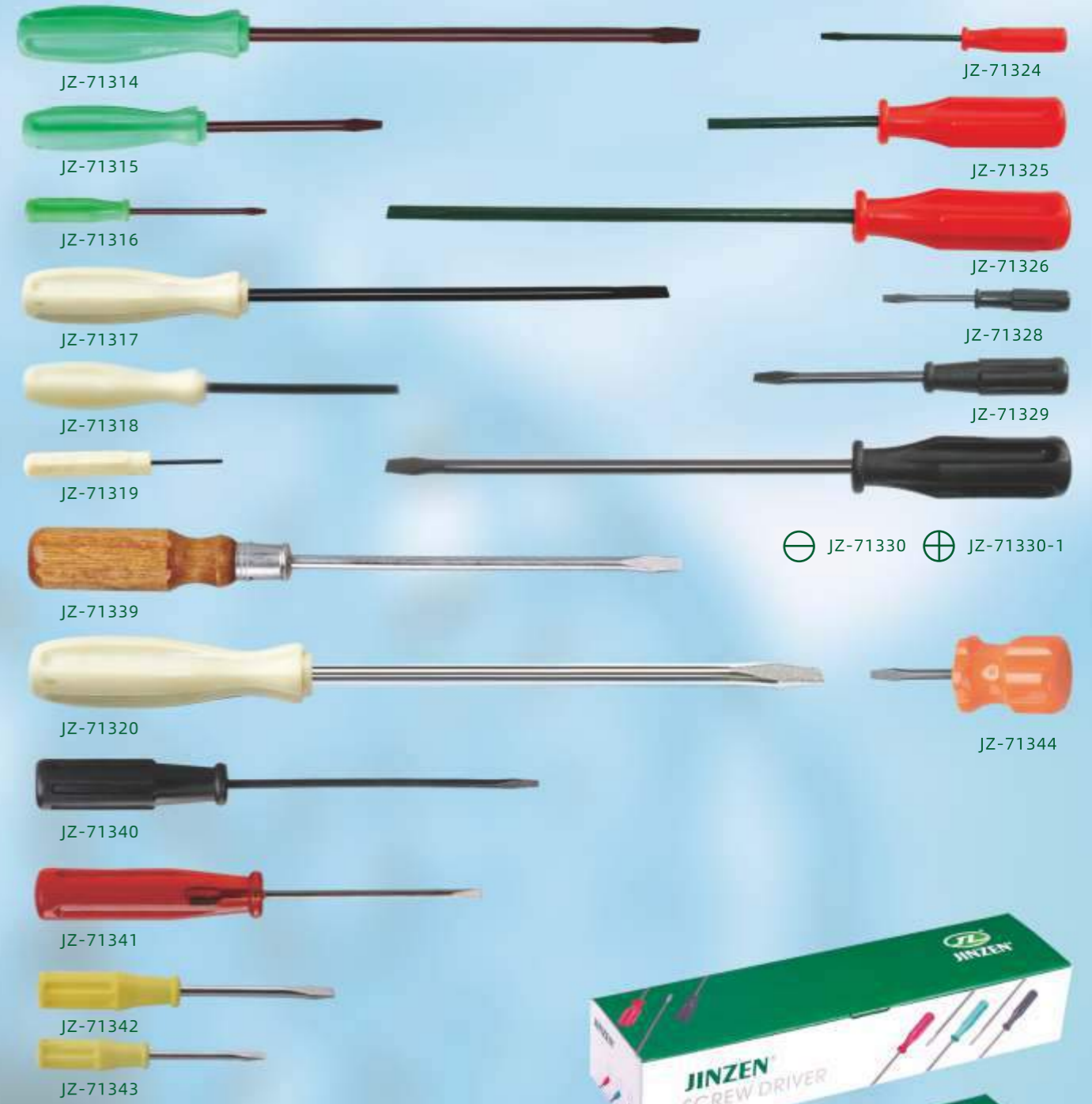

JZ-71314

JZ-71315

JZ-71316

JZ-71317

JZ-71318

JZ-71319

JZ-71339

JZ-71320

JZ-71340

JZ-71341

JZ-71342

JZ-71343

JZ-71324

JZ-71325

JZ-71326

JZ-71328

JZ-71329

⊖ JZ-71330 ⊕ JZ-71330-1

JZ-71344







JZ-71401    JZ-71402    JZ-71403    JZ-71404    JZ-71405    JZ-71406    JZ-71423



JZ-71407    JZ-71408    JZ-71409    JZ-71410    JZ-71411    JZ-71412



JZ-71413    JZ-71414    JZ-71415    JZ-71416    JZ-71417



JZ-71418    JZ-71419    JZ-71420 M18-M65    JZ-71421    JZ-71422

JZ-71424 4/6/8mm

ANY SIZE CAN BE CUSTOMIZED 任何尺寸都可定制



JZ-71450    JZ-71451    JZ-71452    JZ-71453    JZ-71449    JZ-71454    JZ-71455



JZ-71456    JZ-71457    JZ-71458    JZ-71459    JZ-71460    JZ-71461



JZ-71462    JZ-71463    JZ-71464    JZ-71465    JZ-71466    JZ-71467    JZ-71468



JZ-71469    JZ-71470    JZ-71471    JZ-71472    JZ-71473    JZ-71474



JZ-71475 CL12    JZ-71476 CL3    JZ-71477 CL3L    JZ-71478 CL1L    JZ-71479 CL1G    JZ-71480 CL1    JZ-71481 CL2



JZ-71482 CL70    JZ-71483 4" 6" 8" 10"    JZ-71484 4" 6" 8" 10"    JZ-71485 4" 6" 8" 10" 不锈钢STEEL    JZ-71486 4" 6" 8" 10" 不锈钢STEEL    JZ-71487 CL5



JZ-71492    JZ-71490    JZ-71488    JZ-71489    JZ-71491





内六角紧定螺钉  
JZ-71501



球面圆柱头复合槽螺钉  
JZ-71502



六角轴位螺钉  
JZ-71503



六角螺母  
JZ-71504



一字槽沉头螺钉  
JZ-71505



圆柱头螺钉  
JZ-71506



球面圆柱头螺钉  
JZ-71507



圆柱头内六角螺钉  
JZ-71508



圆柱头滚花  
内六角螺钉  
JZ-71509



开槽凹端紧定螺钉  
JZ-71510



JZ-71511



JZ-71512



JZ-71513



JZ-71514



JZ-71515



JZ-71516





JZ-71701



JZ-71702



JZ-71703



JZ-71719



JZ-71720



JZ-71721



JZ-71704



JZ-71705



JZ-71706



JZ-71722



JZ-71723



JZ-71724



JZ-71707



JZ-71708



JZ-71709



JZ-71725



JZ-71726



JZ-71727



JZ-71710



JZ-71711



JZ-71712



JZ-71728 E52四线侧罩



JZ-71729 E32五线侧罩



JZ-71730 747D侧罩



JZ-71713



JZ-71714



JZ-71715



JZ-71732 海菱皮带罩20518



JZ-71733



JZ-71731



JZ-71716



JZ-71717



JZ-71718



JZ-71735 电动机皮带罩(不可调)



JZ-71736



JZ-71734 2516垃圾槽



JZ-71737 522垃圾槽





JZ-71801



JZ-71802



JZ-71803



JZ-71816



JZ-71817



JZ-71818



JZ-71804



JZ-71805



JZ-71806



JZ-71819



JZ-71820



JZ-71821



JZ-71807



JZ-71808



JZ-71809



JZ-71822



JZ-71823



JZ-71824



JZ-71810



JZ-71811



JZ-71812



JZ-71825



JZ-71826

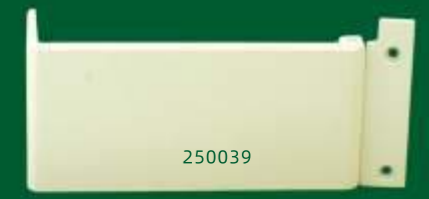

JZ-71827



JZ-71813



JZ-71814



JZ-71815



JZ-71828



JZ-71829



JZ-71830





JZ-71901



JZ-71902



JZ-71903



JZ-71904



JZ-71905



JZ-71906



JZ-71907



JZ-71908



JZ-71909



JZ-71910



JZ-71911



JZ-71912



JZ-71913



JZ-71914



JZ-71915



JZ-71916



JZ-71917



JZ-71918



JZ-71919



JZ-71920



JZ-71921



JZ-71922



JZ-71923



JZ-71924



JZ-71925



JZ-71926



JZ-71938



JZ-71940



JZ-71941



JZ-71942



JZ-71927



JZ-71928



JZ-71929



JZ-71930



JZ-71936



JZ-71937



JZ-71943



JZ-71944



JZ-71945



JZ-71931



JZ-71932



JZ-71933



JZ-71934



JZ-71939



JZ-71946



JZ-71947



JZ-71948





JZ-72101 842



JZ-72105 845



JZ-72106 3168



JZ-72110 555



JZ-72114 GC6-5



JZ-72118 SUNSTAR



JZ-72122 652



JZ-72127 2153



JZ-72102 335



JZ-72107 335



JZ-72111 591



JZ-72115 735



JZ-72119 7200



JZ-72123 1850



JZ-72128 781W



JZ-72103 8810



JZ-72108 820



JZ-72112 GC6-1



JZ-72116 735



JZ-72120 9900



JZ-72124 781



JZ-72129 1900B



JZ-72104 0302



JZ-72109 8810



JZ-72113 5550



JZ-72117 1903



JZ-72121 1900A



JZ-72125 20U



JZ-72126 家用多功能



JZ-72130 家用多功能



JZ-72201 W500



JZ-72202 BR 735



JZ-72203 F007



JZ-72204 M700



JZ-72205 YAMATO



JZ-72206 555



JZ-72207 GC6-1



JZ-72208 M600



JZ-72209 MO3600



JZ-72210 8700



JZ-72211 M600



JZ-72212 MO3300



JZ-72213 747



JZ-72214 551



JZ-72215 1404



JZ-72216 MO3600



JZ-72217 2516



JZ-72218 R53



JZ-72219 GK31010



JZ-72220 MO2516



JZ-72221



JZ-72222



JZ-72223



JZ-72224



JZ-72225



JZ-72226



JZ-72227

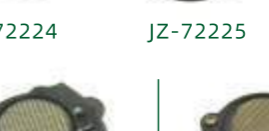

JZ-72228



JZ-72229 GC28-3



JZ-72230 BR735



JZ-72231 BR101



JZ-72232 555



JZ-72233 GC1-9



JZ-72235



JZ-72236 SINGER191



JZ-72237 GC28-1



JZ-72238 JUKI 老款



JZ-72239 SINGER591



JZ-72240 GC6-1





JUKI 271/391

JZ-72301

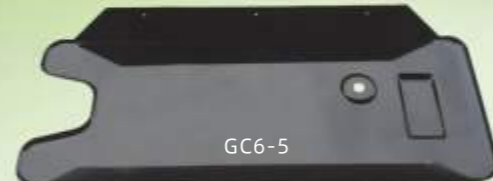

GC6-5

JZ-72302



8810

JZ-72313



W600

JZ-72314



EX3200

JZ-72315

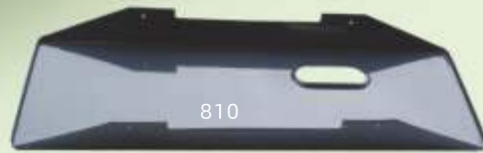

810

JZ-72303



M700

JZ-72304



JUKI 373

JZ-72316



747

JZ-72317

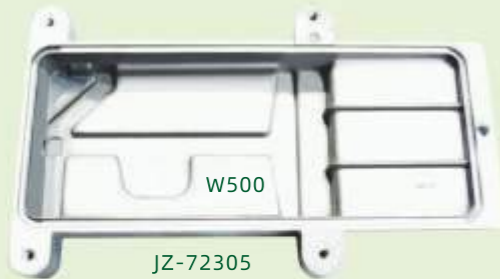

W500

JZ-72305



MO3300

JZ-72306



2516

JZ-72318



MO2516

JZ-72319

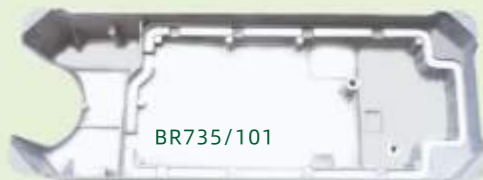

BR735/101

JZ-72307



GC6-1

JZ-72308

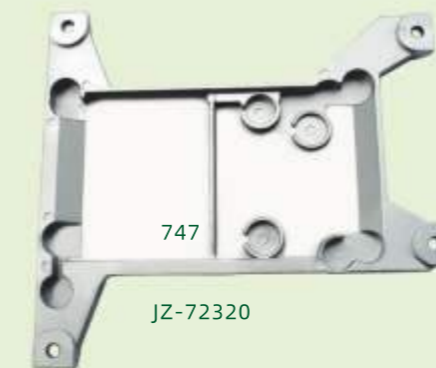

747

JZ-72320

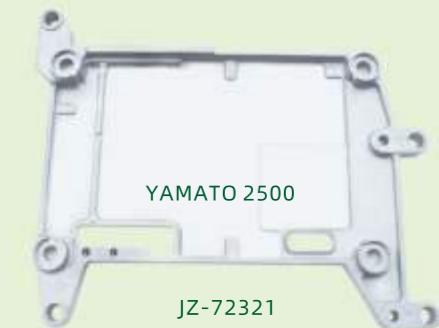

YAMATO 2500

JZ-72321



JUKI 5550

JZ-72309



JUKI3168

JZ-72310



BR842

JZ-72311



380

JZ-72312



781

JZ-72322



JUKI 1850

JZ-72323





JZ-72396 多功能橡筋架

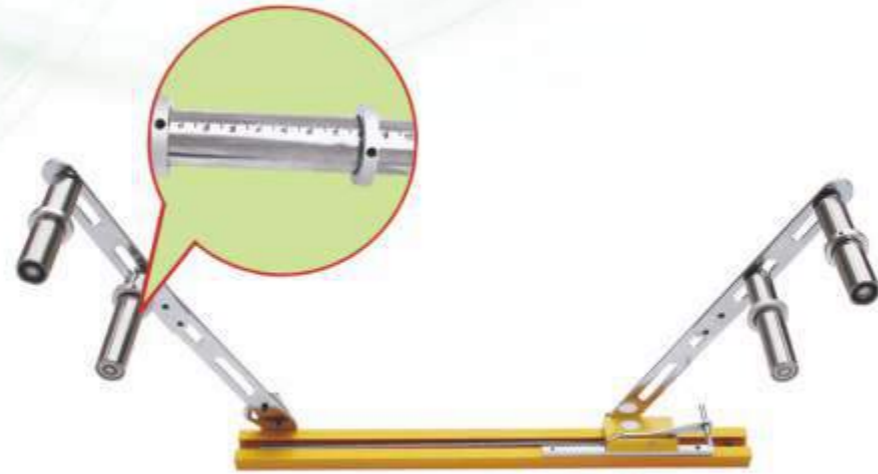

JZ-72402 特殊铝质 (加大码)  
活动啤唛架 (橡筋架)  
专用于: 橡筋车  
裤头车



JZ-72397 扩展架 A



JZ-72403 固定啤唛架 (橡筋架)  
专用于: 橡筋车  
裤头车



JZ-72404 特殊铝质  
活动啤唛架 (橡筋架)  
专用于: 橡筋车  
裤头车

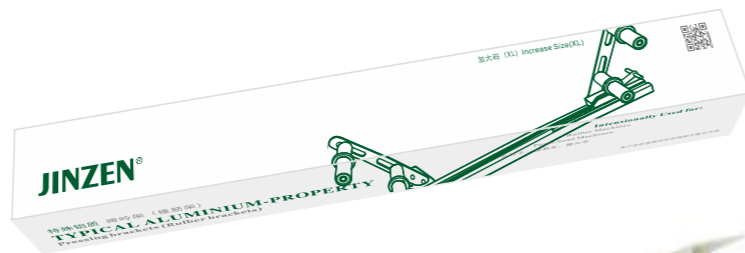

JZ-72398 扩展架 B



JZ-72399 PDF(B)小嘴包缝机固定小滚轮



JZ-72400 筒式绷缝机滑轮器  
PULLEY FOR CYLINDER TYPE  
INTERLOCK SEWING MACHINE



JZ-72405 拉布机  
适用于: 雨伞、牛仔等滑、厚料

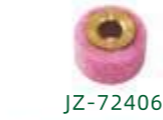

JZ-72406



JZ-72407



JZ-72408



JZ-72409



JZ-72410



JZ-72411



JZ-72412



JZ-72413



JZ-72414



JZ-72415



JZ-72416



JZ-72417



JZ-72418



JZ-72419



JZ-72420



JZ-72421



JZ-72422



JZ-72448



JZ-72424



JZ-72425



JZ-72426



JZ-72427



JZ-72428



JZ-72429



JZ-72430

ALC(铝)

45mm	80mm
50mm	85mm
55mm	90mm
60mm	95mm
65mm	100mm
70mm	110mm
75mm	120mm



JZ-72449

锥形孔

45mm	80mm
50mm	85mm
55mm	90mm
60mm	95mm
65mm	100mm
70mm	110mm
75mm	120mm



JZ-72432

8uf	24uf
10uf	25uf
12uf	28uf
14uf	30uf
16uf	38uf
18uf	50uf
20uf	70uf



JZ-72433

8uf	24uf
10uf	25uf
12uf	28uf
14uf	30uf
16uf	38uf
18uf	50uf
20uf	70uf



JZ-72434



JZ-72436



JZ-72435

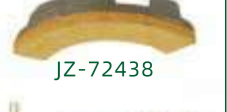

JZ-72438

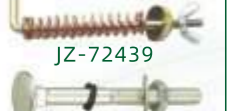

JZ-72439

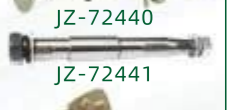

JZ-72440



JZ-72437



JZ-72441



JZ-72442



JZ-72444



JZ-72443



JZ-72445



JZ-72446



JZ-72447





JZ-72502  
T3 228777



JZ-72501  
T2 228776



JZ-72506  
T3 228777



JZ-72503

Thread Stand	F2	F3	F4	F5	F6	F8	F12
--------------	----	----	----	----	----	----	-----



JZ-72504



JZ-72505



JZ-72522



JZ-72523



JZ-72521



JZ-72528



JZ-72524



JZ-72525



JZ-72526



JZ-72527 衣料斗





专业专注，全心服务  
Professional focus, whole-hearted service



JZ-72577  
裁布电剪刀  
8" / 10"



JZ-72560  
伺服电剪



JZ-72563



JZ-72562



JZ-72561  
JZ-72561A 长手柄 LONGHANDLE



JZ-72564



JZ-72582



JZ-72583



JZ-72578



JZ-72579





JZ-72568

JZ-72569

JZ-72570

JZ-72571



JZ-72572



JZ-72580



JZ-72581



JZ-90201  
商标切割机  
TRADEMARK  
CUTTING MACHINE



JZ-90200  
商标切割机



JZ-72584  
电子大白扣



JZ-72573



JZ-90205



JZ-90208



JZ-90209



JZ-90213



JZ-90210



JZ-90199



JZ-90211



JZ-90212



JZ-90214 大贝壳装置  
JZ-90214-1 小贝壳装置



JZ-90202



JZ-90215



JZ-72576



JZ-90204  
全自动  
梭心卷线机  
BOBBIN WINDER



JZ-90203  
挂烫机





JZ-90301 便携剪



JZ-90302刀头

JZ-90303 电池



JZ-90304 便携剪



JZ-90305  
电脑分线机



JZ-90306 热熔枪



JZ-90307 绕扣机



JZ-90308  
气动钉扣



JZ-90309  
单头分线机



JZ-90310  
四头分线机



JZ-90315  
充棉吹风机



JZ-90316  
剪成人裤耳  
Cut adult  
belt buckles



JZ-90317  
剪儿童裤耳  
Cut belt buckles for  
children's pants



JZ-90318  
智能绕线器



JZ-90319  
双头剪线机



JZ-90320  
冷热切带机

JZ-90311  
带轨道粘合机带

JZ-90312  
无缝粘合机带

JZ-90314  
有缝粘合机带 (黑)

JZ-90313  
有缝粘合机带 (白)



# One-stop solution

缝配服务一站式采购

JINZEN®



JZ-90351 气动卷边筒



JZ-90352 气动型滚轮扩张装置



JZ-90353 TK刀组切带



JZ-90354 包缝机后拉滚轮

JZ-90367



JZ-90355 绷缝机刀组



JZ-90356 气动橡津架



JZ-90357 调速器外壳



JZ-90358 停针器



JZ-90359 0303倒缝



JZ-90360 外置传感器



JZ-90361 6150切线



JZ-90362 包缝剪线



JZ-90363 下挂式节能电机



JZ-90364 气动埋夹机切刀



JZ-90365 一体加装直驱 (顶加绕线器)



JZ-90366 包缝直驱电机





1404 4N 28X23T 22X18T  
JZ-72701



1404 4N 黑胶  
JZ-72702



1404 4N 黄胶  
JZ-72703



1702 黄胶  
JZ-72716



1702 铁齿  
JZ-72717



1702 铁氟龙  
JZ-72718



1412 12NN28X23T 22X18T  
JZ-72704



1412 12N 黑胶  
JZ-72705



1412 12N 黄胶  
JZ-72706



VC008 4N 12N 尼龙  
JZ-72719



VC008 4N 12N 黑胶  
JZ-72720



VC008 4N 12N 黄胶  
JZ-72721



1508 铁齿  
JZ-72707



1508 滚花轮  
JZ-72708



1412 铁齿  
JZ-72709



1404 灰胶后拖轮  
JZ-72747



1508 新款铁齿  
JZ-72723



4412 尼龙  
JZ-72724



W600 后拖轮黄胶  
JZ-72710



W600 后拖轮尼龙  
JZ-72711



982 拖轮  
JZ-72712



青柳 25N 33N 35N 43N 后拖轮  
JZ-72725

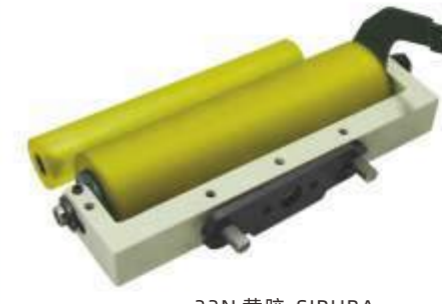

33N 黄胶 SIRUBA  
JZ-72726



VC008-33N 齿后拖轮  
JZ-72727



1508PR 自动转弯拖轮 铁齿  
JZ-72713



1508PR 自动转弯拖轮 黄胶  
JZ-72714



1508PR 上轮  
JZ-72715



33N 黄胶轮 KASAI  
JZ-72728



MD 前拖轮 白  
JZ-72729



(6)MD 前拖轮 绿  
JZ-72730





JZ-72750  
4404细齿后拖轮



JZ-72748  
1503橡胶后拖轮



JZ-72749  
1503铁齿后拖轮



JZ-72757  
35800铁齿上拖轮(于仁)



JZ-72758  
35800铁齿上拖轮(重机)



JZ-72759  
926铁齿上拖轮



JZ-72760  
927黄胶带齿



JZ-72754  
大和橡胶上拖轮



JZ-72751  
4412橡胶后拖轮



JZ-72752  
4412铁齿后拖轮



JZ-72769  
928黄胶



JZ-72770  
927黄胶



JZ-72771  
927黄胶带齿



JZ-72772  
927铁轮



JZ-72773  
928



JZ-72774A



JZ-72774B



JZ-72775  
长臂车轮子



JZ-72776  
927



JZ-72763  
关西33N细齿后拖轮



JZ-72755  
大和橡胶下拖轮



JZ-72767  
1412新款后拖轮



JZ-72753  
VC008-25N橡胶后拖轮



JZ-72762  
青柳33N齿后拖轮



JZ-72765  
青柳50N橡胶后拖轮



JZ-72777



JZ-72756  
关西33N前拖轮



JZ-72764  
VC008-33N前拖轮



JZ-72768  
VC008 33N 过线下拖轮组件



JZ-72766  
W664 前拖轮







1404 4N 28\*23T  
JZ-72731



1404 4N 22\*18T  
JZ-72732



1404 12N 28\*23T  
JZ-72733



1404 12N 22\*18T  
JZ-72734



VC008胶轮  
JZ-72735



4N黄胶轮 4N/12N  
JZ-72736



VC008黄胶轮  
JZ-72737



2000C后拖轮  
JZ-72738



1404 4N 黑胶轮  
JZ-72739



1404 12N 黑胶轮  
JZ-72740



1508铁轮  
JZ-72741



4404 尼龙  
JZ-72742



2000C前拖轮  
JZ-72743



411146双  
JZ-72801



411360  
JZ-72802



411364  
JZ-72803



411462  
JZ-72804



411146单  
JZ-72805



VC008前拖轮 4N  
JZ-72744



JZ-72745



W500 前拖轮组  
JZ-72746



JZ-72901 GC6-1



JZ-72902 810



JZ-72903 555



JZ-72904 SINGER



JZ-72905 BR735



JZ-72906 双针



JZ-72907 5550



JZ-72908 20U



# 吸风装置

套装不含红色选区



JZ-89997

JZ-89998



JZ-89999 **PEGASUS EX**一体机刀组



JZ-90000 **PEGASUS EX**直驱刀组



JZ-90001 **JAMATO** AZ-6020 2109917(K2)



JZ-90006 **JAMATO** AZ-6000 2109906K1



JZ-90002 **JUKI** MO-3900 T041



JZ-90007 **JUKI** MO-2400 T035



JZ-90003 **JUKI** MO-2304 T036



JZ-90008 **JUKI** MO-3614 T042



JZ-90004 **SIRUBA** 747 VT



JZ-90009 **PEGASUS** M752 304294-91Y



JZ-90005 **PEGASUS** E32 301235



JZ-90010 **PEGASUS** E32 (35) 301030

# JINZEN®

麦金缝制机械 INDUSTRIAL SEWING MACHINE

包缝机切线刀组(型号表) CHAIN CUTTER ASSEMBLY SERIES

## JUKI

MODEL	TYPE	适用机型AVAILABLE MODEL
to-36	侧吸PNEUMATIC SIDECUTTER	mo-2304,2314,2404,2414
to-42		mo-3604,3614,3904,3914,6704,6714,6904,6914
ts-42		mo-3304,3314
to-22	平吸PNEUMATIC FLAT CUTTER	mo-2500
to-35		mo-2300,2400
to-41		mo-3600,3900,6700,6900
tf-35		mo-2300,2400

## Jamato

MODEL	TYPE	适用机型AVAILABLE MODEL
2109917(k2)	侧吸PNEUMATIC SIDECUTTER	AZ-6020,8020
2159901(k2)		
2109906(k1)	平吸PNEUMATIC FLAT CUTTER	AZ-6000,8000
2159900(k1)		

## brother

MODEL	TYPE	适用机型AVAILABLE MODEL
S24273-001	侧吸PNEUMATIC SIDECUTTER	V&N Series
S43547-001	平吸PNEUMATIC FLAT CUTTER	V&N Series

## SIRUBA

MODEL	TYPE	适用机型AVAILABLE MODEL
VT	侧吸PNEUMATIC SIDECUTTER	737,747
CT	平吸PNEUMATIC FLAT CUTTER	737,747,757,767

## Kingtex

MODEL	TYPE	适用机型AVAILABLE MODEL
SS-023	侧吸PNEUMATIC SIDECUTTER	SHG-6005,SHG-7005
US-027	平吸PNEUMATIC FLAT CUTTER	SH-6003,SH6004,SH-7003,SH-7004
US-035		SH-6000,SH-7000

## PEGASUS

MODEL	TYPE	适用机型AVAILABLE MODEL
KS-301148(KS002)	侧吸PNEUMATIC SIDECUTTER	E52
KS-308046-91Y(KS371)		EX5204,EX5214,LX5204,LX5214
KS-304272-91Y(KS026)		M652L52
KS-304294-91Y(KS391)		M752
KH-301030(KH001)	平吸PNEUMATIC FLAT CUTTER	E32(35)
KH-301235(KH003)		E32(55)
KH-303753(KH010)		L132(35)
KH-303754(KH012)		L132(55)
KH-308020A-91Y(KH020A)		EX3200,LX3200
KH-303753A-91Y(KH016)		M632
KH-304308A-91Y(KH018A)		M732,M752
KH-308100B-91Y		EXT3200,EXT5200





JZ-90011

JZ-90012

JZ-90013

JZ-90014

JZ-90015 4x2.5 6x4 8x5.5 10x6.5

JZ-90016

JZ-90017

JZ-90018

JZ-90019



JZ-90111

JZ-90112

JZ-90103

JZ-90104

JZ-90105

JZ-90106



JZ-90130

JZ-90131

JZ-90132

JZ-90133

JZ-90134

JZ-90137

JZ-90136

JZ-90139

JZ-90135



JZ-90138

JZ-90140  
140/160cm

JZ-90141

JZ-90142  
55/60/78cm

JZ-90143

# 成衣剪线机 THREAD TRIMMER



JZ-90113



JZ-90114



JZ-90115



JZ-90116



JZ-90117



JZ-90118



JZ-90119



JZ-90120



JZ-90121



JZ-90122



JZ-90123



JZ-90124



JZ-90125





JZ-91481



JZ-91482



JZ-91483



JZ-91484

### 品牌型号对照表

切线装置	适用机型	
	品牌	型号
VF-2500	雅满桃 YAMATO	CF-2300
		VF-2500
	精机(宝狮) KINGTEX	FT-6500
		星菱 SHINGLING
	高机 K-CHANCE	VF-3500
		飞跃 FEI YUE
	中捷 ZOJE	ZJ2500A-156M-VF
	标准 TYPICAL	CK350系列
		CK-32500
	VC-2700	雅满桃 YAMATO
VC-2700M		
CC-2700		
VC-2700		
VC-2742P		
VC-3711		
精机(宝狮) KINGTEX		CT-6500
		高机 K-CHANCE
飞跃 FEI YUE		FY-2700
标准 TYPICAL		CK32700-1356D

切线装置	适用机型	
	品牌	型号
VT-1500	雅满桃 YAMATO	VT-1500(弯三本)
		VE-2713
W-600	美马 PEGASUS	W-664
		飞跃 FEI YUE
	杰克 JACK	JK-8668左修刀
		JK-8668
	宝石 GEMSY	CEM600D
CEM600A-01		
W-500	美马 PEGASUS	W-562
		W-562N
	飞跃 FEI YUE	FY31016
	杰克 JACK	JK-8568
		宝石 GEMSY
W-1500	美马 PEGASUS	W-1562
W-1600	W-1664	
C007J	银箭(高林) SIRUBA	C007J
		C007JW712(新左切刀)
	通宇 PROTEX	TY-C007J
		宝石 GEMSY
	中捷 ZOJE	ZJC2500

切线装置	适用机型	
	品牌	型号
F007J	银箭(高林) SIRUBA	F007J
		飞跃 FEI YUE
	通宇 PROTEX	TY-F007J
CT-7000	精机(宝狮) KINGTEX	FT-7000
CT-9000	CT-9000	
VG-888S	星菱 SHINGLING	VG-888S
VG-888A		VG-888A
MF-7723	重机 JUKI	MF-7723
MF-7823		MF-7823
RX9803	关西(森木) KANSAI SPECIAL	RX-9803
WX8803		WX8803
FW787	星锐 SHINGRAY	FW787
FW720		FW720
VG-2700	雅满桃 YAMATO	VG-3721(左切刀)
		VG-2735(右切刀)
	标准 TYPICAL	CK370D系列

## JINZEN®

### AUTO THREAD TRIMMER DEVICES 自动剪线组件



JZ-91500

#### Yamato 大和1500





**Yamato**  
大和V2700

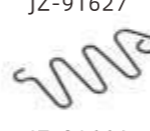
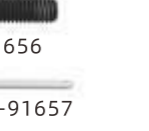

**JINZEN®**

AUTO THREAD TRIMMER DEVICES  
自动剪线组件

**PEGASUS**  
飞马W500





# JINZEN®

## AUTO THREAD TRIMMER DEVICES

### 自动剪线组件



JZ-91800

### PEGASUS 飞马W600



### SHING LING 星菱888A

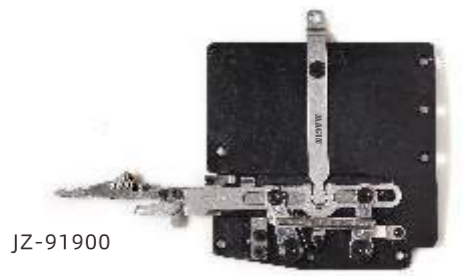

JZ-91900





JZ-92000

SHING LING

星菱888S



JZ-92001



JZ-92006



JZ-92012



JZ-92018



JZ-92024



JZ-92030



JZ-92036



JZ-92042



JZ-92048



JZ-92053



JZ-92054



JZ-92055



JZ-92056



JZ-92057



JZ-92058



JZ-92002



JZ-92007



JZ-92013



JZ-92019



JZ-92025



JZ-92031



JZ-92037



JZ-92043

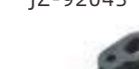

JZ-92049



JZ-92059



JZ-92061



JZ-92062



JZ-92066



JZ-92067



JZ-92003



JZ-92008



JZ-92014



JZ-92020



JZ-92026



JZ-92032



JZ-92038



JZ-92044



JZ-92050



JZ-92060



JZ-92062

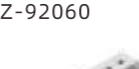

JZ-92066



JZ-92067



JZ-92004



JZ-92009



JZ-92015



JZ-92021



JZ-92027



JZ-92033



JZ-92039



JZ-92045



JZ-92051



JZ-92063

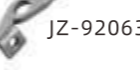

JZ-92065



JZ-92066



JZ-92067



JZ-92005



JZ-92010



JZ-92016



JZ-92022



JZ-92028



JZ-92034



JZ-92040



JZ-92046



JZ-92052



JZ-92064



JZ-92065



JZ-92066



JZ-92067

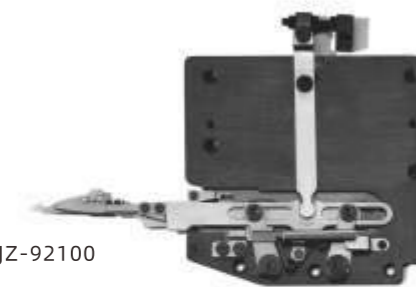

JZ-92100

XINGRUI

星锐787



JZ-92101



JZ-92106



JZ-92112



JZ-92118



JZ-92124



JZ-92130



JZ-92136



JZ-92142



JZ-92148



JZ-92154



JZ-92155



JZ-92156

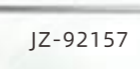

JZ-92157



JZ-92102



JZ-92107



JZ-92113



JZ-92119



JZ-92125



JZ-92131



JZ-92137



JZ-92143

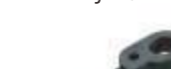

JZ-92149



JZ-92158



JZ-92159



JZ-92160

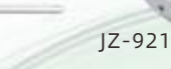

JZ-92161



JZ-92103



JZ-92108



JZ-92114



JZ-92120



JZ-92126



JZ-92132



JZ-92138



JZ-92144

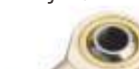

JZ-92150



JZ-92160



JZ-92161



JZ-92162

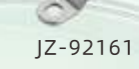

JZ-92163



JZ-92104



JZ-92109



JZ-92115



JZ-92121



JZ-92127



JZ-92133



JZ-92139



JZ-92145



JZ-92151



JZ-92162



JZ-92163



JZ-92164

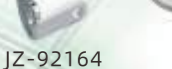

JZ-92165



JZ-92105



JZ-92110



JZ-92116



JZ-92122



JZ-92128



JZ-92134



JZ-92140



JZ-92146



JZ-92152



JZ-92164



JZ-92165



JZ-92165

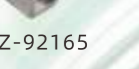

JZ-92165



# JINZEN®

AUTO THREAD TRIMMER DEVICES  
自动剪线组件

Kingtex

宝狮CT6500



JZ-92200



## 针织裤头松紧带车缝

(简易膝动式)

KNIT ELASTIC WAIST BAND ATTACHING  
(MANUAL TYPE)

Kingtex 精机



JZ-90092

XINGRUI 星锐



JZ-90094

SHING LING 星菱



JZ-90091

Ijamoto 大和

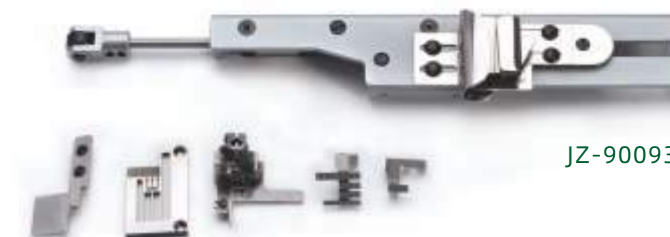

JZ-90093

PEGASUS 飞马

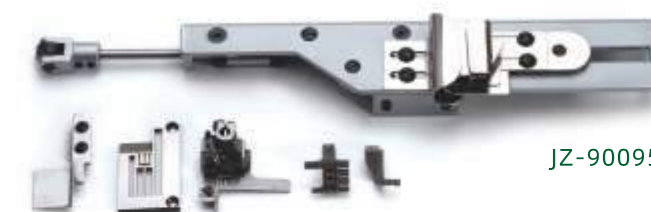

JZ-90095

## SEWING ACCESSORIES 车缝附件



JZ-90096





# Puller attachment

拖轮系列产品

## 拖轮系列产品 Puller Attachment

**JZ-HPL** 單針、雙針車用 一般布料型  
FOR SINGLE OR TWIN NEEDLE (General material)

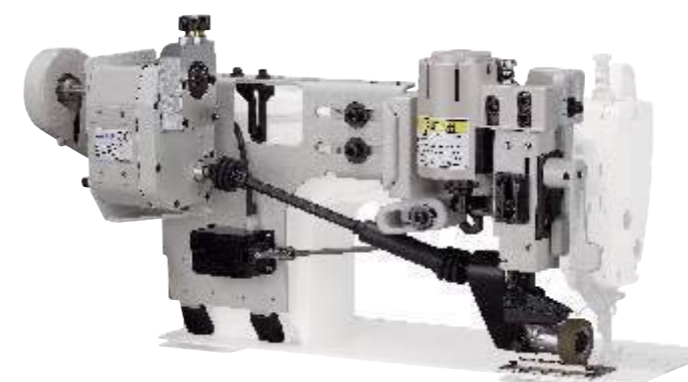

L×W×H:615×374×238mm

具有多種選擇性拖輪 能適應不同質料之車縫。  
With various optional rollers for different kinds of sewn materials.

下有滾軸底盤與拖輪上下滾動，使布料移動更加順暢。  
The roller could roll with the rolling-plate, cloth can be moved more smooth.

滾輪尺寸：直徑55mm，寬度15/35/55mm  
Roller: Diameter 55mm, Width 15/35/55mm



**JZ-HPS** 小輪、單針、雙針車用 (薄物短距型)  
FOR SMALL ROLLER SINGLE OR TWIN NEEDLE Short thin material



L×W×H:615×374×238mm

拖輪與車針距離超近，適合薄物，短距離及彎弧車縫。

Extremely close pulling facilitates curve and short sewing on thin materials

滾輪尺寸：直徑25mm，寬度15mm  
Roller Diameter 25mm, Width 15mm



**JZ-HPZ-380** 鏈目縫車專用型  
FOR SPECIFIC FLAT BED CHAINSTITCH



L×W×H:615×374×238mm

縫制西裝褲專用，例如JUKI-380  
For sewing career/dress pants, EX: JUKI-380

滾輪尺寸：直徑55mm，寬度15、35、55mm  
Roller: Diameter 55mm, Width 15/35/55mm





**JZ-HPL-S1** 飾縫車用 (一般布料型)  
FOR FLAT BED COVERSTITCH (General material)



L×W×H:615×374×238mm

滾輪尺寸: 直徑55mm,  
寬度15/35/50mm  
Roller: Diameter55mm,  
width15/35/50mm

**JZ-HPT** 單針、雙針車用, 上下輪驅動 (加強型)  
FOR SINGLE OR TWIN NEEDLE WITH UPPER AND LOWER ROLLER (strengthened type)



L×W×H:615×374×238mm

上下輪同時驅動 拉力特強 縫制順暢  
Powerful upper and lower rollers drive

適合薄至極厚物 長距離車縫  
For thin to heavy material

上輪 直徑55mm 寬度15/35/50mm  
下輪 直徑27mm 寬度60mm  
Upper roller: Diameter55mm,width15/35/50mm  
Lower roller: Diameter27mm,width60mm

**JZ-HPL-S2** 筒型飾縫車用 一般布料型  
FOR CYLINDER BED COVERSTITCH (General material)



L×W×H:615×374×238mm

附專用基座及下輪  
Special bracker and lower roller  
上輪 直徑55mm,寬度15/35/50mm  
下輪 直徑27mm,寬度60mm  
Upper roller:Diameter55mm,width15/35/50mm  
Lower roller:Diameter27mm,width60mm



**JZ-HPK** 包縫車用 上下輪驅動 薄至厚物長距型  
FOR OVERLOCK WITH UPPER AND LOWER ROLLER (Thin to very thick material)

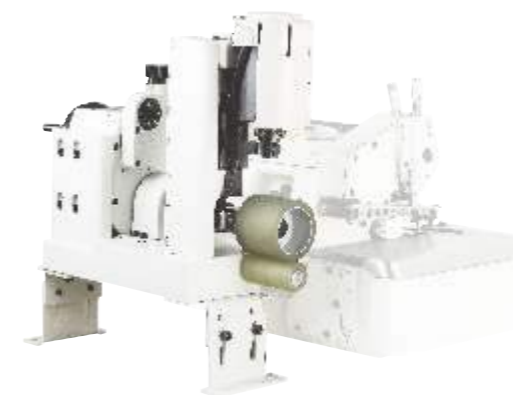

L×W×H:615×374×238mm

適用於薄至極厚物的直綫縫制  
Suitable for thin to extremaly thick materials in straight sewing

上輪 直徑55mm 寬度15/35/50mm  
下輪 直徑27mm 寬度60mm  
Upper roller: Diameter55mm,width15/35/50mm  
Lower roller:Diameter27mm,width60mm

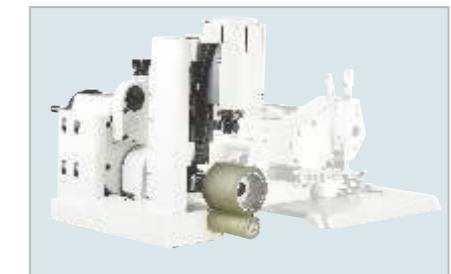

下沈式 Submerged type

**JZ-HPF** 腕型車用, 皮帶式拖輪 極厚物型  
FOR FEED-OFF-ARM  
(Belt puller for heavy to extremely heavy material)



L×W×H:615×374×238mm

皮帶式拖輪, 拉力特強。  
Belt puller for powerful pulling strength

皮帶寬帶: 19mm  
Belt width: 19mm



**JZ-HPK-SP** 前拉式 (意大利面專用)  
FRONT PULLER (Special for spaghetti)



L×W×H:615×374×238mm

上輪 直徑55mm 寬度15/35/50mm  
下輪 直徑27mm 寬度60mm  
Upper roller: Diameter55mm,width15/35/50mm  
Lower roller:Diameter27mm,width60mm



**JZ-HCS** 袖口縫制輔助裝置 (筒型車適用, 如JUKI DSC-246、金輪CS 8703)  
Rear Puller with Pneumatic roller tensioner (For Cylinder-Bed machines, such as JUKI DSC-246 Golden-Wheel CS-8703)

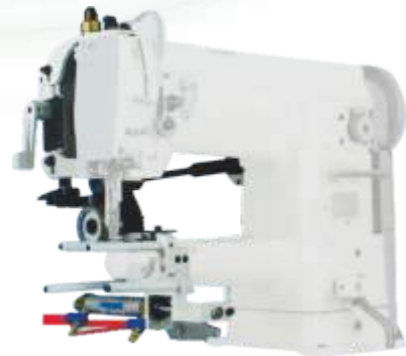

LxWxH: 450x274x193mm

以滑輪式的氣動裝置 (附壓力表) 可配合袖口、褲管等物料之不同大小可調節自如, 並因滾輪軸之固定作用使縫制作業更為輕鬆, 能有效減少不良品的消耗近而提高產能。  
The roller tensioner is governed by air gauge thus the tension as well as the tubular circumference of different material can be adjusted easily to increase productivity and reduce waste.

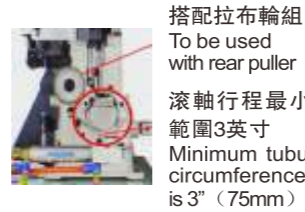

搭配拉布輪組  
To be used with rear puller

滾軸行程最小範圍3英寸  
Minimum tubular circumference is 3" (75mm)



可不加裝拖輪組  
Rear puller is eliminated

滾軸行程最大範圍6英寸  
Maximum tubular circumference is 6" (150mm)

**JZ-HPF-HB/PCV/AF**

厚物、極厚物用皮帶式拖輪  
BELT PULLER FOR HEAVY TO EXTREMELY HEAVY DUTY MATERIAL



氣動式自動切線裝置 (一般腕型車用)  
Chain cutter for Off-the-Arm



氣動式自動切線裝置 (四針六線車用)  
Chain cutter for 4 NEEDLE / 6 THREAD Feed-Off-the-Arm



AF 氣壓式壓腳裝置 (一般腕型車用)

PNEUMATIC PRESSURE FOOT (FOR FEED-OFF-THE-ARM)



**JZ-HPB** 褲頭車用 上下輪驅動 厚物型  
FOR SPECIFIC WAISYBAND WITH UPPER AND LOWER ROLLER (Heavy duty)

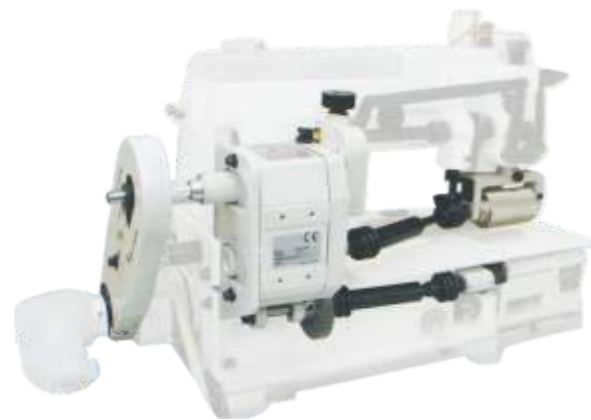

強力驅動, 可防止針目大小不一  
Powerful driver making equal stitches.  
適用於牛仔布等厚物  
Suitable for heavy material. ex: jeans



**JZ-HPG** 包縫車用, 小輪 (薄物用)  
FOR OVERLOCK WITH SMALL ROLLER (For thin material)



LxWxH: 365x365x300 mm

本拖輪不能裝在附有水平或垂直式自動切線裝置的包縫車上  
This puller unable to install onto overlock machine with either vertical or horizontal automatic thread-chain cutter.

HPG系列所需要的基本空間

Space Limitation For HPG Series:

JUKI MO 3000,6000	SERIES
PEGASUS EX, MX, M	SERIES
BROTHER N, V	SERIES
YAMATO AZ 8000, 6000	SERIES
SIRUBA 757H	SERIES



**JZ-HPY**

單針、雙針車用, 上下輪驅動  
FOR SINGLE OR TWIN NEEDLE WITH UPPER AND LOWER ROLLER



LxWxH: 615x374x238 mm N.W./G.W.: 9 / 10 kgs

**JZ-HPY-C**

飾縫車用  
FOR COVERSTITCH



LxWxH: 615x374x238 mm N.W./G.W.: 9 / 10 kgs

**JZ-HPY-SP**

前拉式 (意大利麵專用)  
FRONT PULLER (For spaghetti sewing)



LxWxH: 615x374x238 mm N.W./G.W.: 9 / 10 kg

**JZ-HPR**

包縫車用, 皮帶後送 (薄物用)  
FOR OVERLOCK WITH REAR DRIVE BELT (For thin material)



不受空間限制, 各種廠牌機型均可安裝。  
Suitable for every machine without space limitation.  
獨特設計, 皮帶與車針距離超近  
Close proximity of rear drive belt and needle improves sewing performance.  
適用於柔軟光滑、易皺的薄物  
Suitable for silky and easy-pucker thin materials.





### JZ-HMDK-61

包縫車專用型(基座固定于機頭上方)  
FOR SPECIFIC OVERLOCK  
(Base is mouted on the machine head)



送帶寬度Feeding:50mm  
L×W×H:450×274×193mm

### JZ-HMDK-60

包縫車專用型(基座固定在車板上)  
FOR SPECIFIC OVERLOCK (Base is mouted on the table)



送帶寬度Feeding:50mm  
L×W×H:450×274×193mm

### JZ-HTFU-600

上送型送料機(一至三條)  
UPPER TAPE FEEDER (1-3LINES)

專為縫制運動衣褲之三點條而研發  
Specially developed for sportswear with 3  
tapers striped  
三組馬達獨立運行  
Three sets of motors operate Independently  
可同時送料一至三條  
At the same time feeding 1-3 lines  
固定架式,各機種均適用  
Fixed frame.All models are applicable

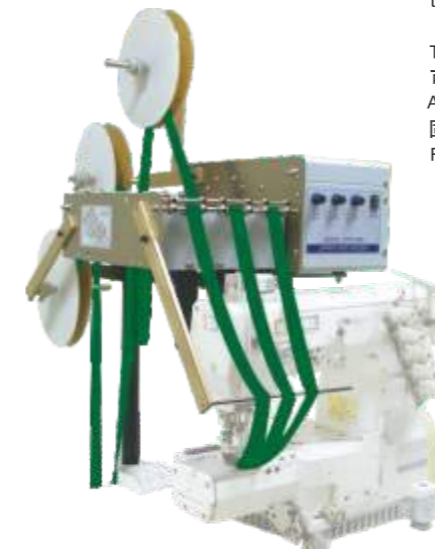

送帶寬度  
Feeding width : 40mm

L×W×H:510×420×255mm

### JZ-HTFU-202A

電動型防止打結裝置  
UNTRANGLING MOTOR DEVICE



LxWxH: 365x365x300 mm

旋轉式能更有效的防止鬆緊帶打結與纏繞  
To by the Rotational motion, effectively to  
untanglethe twisted or gathered elastic tape.

### JZ-HMDL-31

千鳥車專用型(基座固定于機頭上方)  
FOR SPECIFIC ZIG-ZG  
(Base is mouted on the machine head)



送帶寬度Feeding:50mm  
L×W×H:450×274×193mm



送帶裝置位置較低。  
Metering device position low

### JZ-HMDL-30

千鳥車專用型(基座固定于車板上)  
FOR SPECIFIC ZIG-ZG  
(Base is mouted on the table.)



送帶寬度Feeding:50mm  
L×W×H:450×274×193mm



### JZ-HTFU-200

上送型送料機(送料寬度70mm)  
UPPER TAPE FEEDER(Feeding width 70mm)

### JZ-HTFU-200-8

上送型送料機(送料寬度200mm)  
UPPER TAPE FEEDER(Feeding width 200mm)



L×W×H:325×365×200mm  
L×W×H:450×274×193mm

### JZ-HTFS-230

側送型送料機(送料寬度70mm)  
SIDE TAPE FEEDER(Feeding width 70mm)

### JZ-HTFS-230-8

側送型送料機(送料寬度200mm)  
SIDE TAPE FEEDER(Feeding width 200mm)

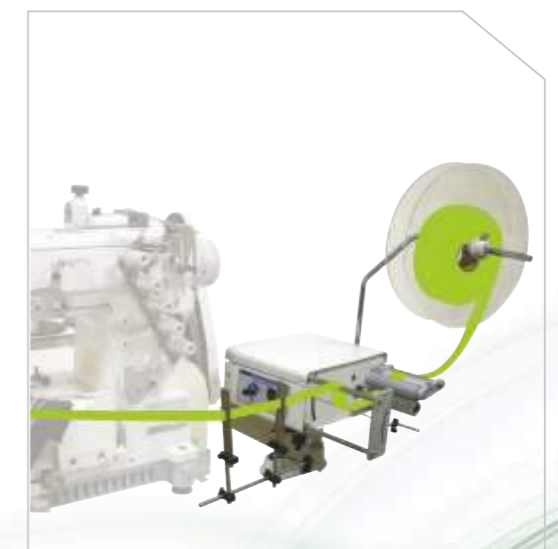

L×W×H:325×365×200mm  
L×W×H:450×274×193mm



## JZ-HCT-888

微電腦全方位送帶機  
VERSATILITY TENSION TYPE COMPUTERIZED METERING DEVICE



LxWxH: 450x300x250 mm



安裝於皮帶輪端的計數器，  
可計算車縫針數(選擇配件)  
Fits on the machines hand  
wheel to control automatic  
section changes (Optional parts).



無張力開關(標準配件)  
Free Tape Function Switch.  
(Standard)



LED+手動換段(選擇配件)  
LED and manual section  
changes. (Optional parts)



膝動換段開關(標準配件):  
工程換段用  
Knee Switch(Standard):  
For manual sectionchanges.

## JZ-HCT-888U

微電腦送料機  
TENSION TYPE COMPUTERIZED METERING DEVICE



LxWxH: 450x300x250 mm

微電腦送料機專為車縫鬆緊帶而研發，控制盒液晶顯示操控，簡易設定，操作隨心所欲，鬆緊帶平順，是縫製內衣褲的最佳利器！

Tension type computerized metering device specialized in sewing the elastic tape, LCD display control box, easy setup, easy operation, arbitrary, increase your productivity, This the best tool for Manufacturing underwear!

## JZ-HCP-520

直驅式電子平車拖輪  
PULLER WITH DIRECT-DRIVING COMPUTERIZED



LxWxH: 365x365x300 mm



Power: 110V~240V, 50/60Hz

## JZ-HCP-530

直驅式電子平車拖輪  
PULLER WITH DIRECT-DRIVING COMPUTERIZED



可與車針同步，縫針不易斷裂。  
Simultaneous speed, the needle is unbreakable.  
智慧型拖輪，可調針目大小。  
Smart puller, adjusted distance.  
倒針時，拖輪同時反方向轉動，免提起拖輪，減低噪音。  
Puller can be pull back when reverse sewing.  
多機種皆適用，如：平車、三本車、人字車、埋夾車、包縫車。  
Many models are applicable.





**JZ-HCT-E9U-M**

微电脑全方位送松紧带送带机系列产品/  
上送型/荧幕操控  
TENSION TYPE COMPUTERIZED METERING DEVICE-UPPER  
FEEDING-MONITOR OPERATION



**JZ-HCT-E9S-M**

微电脑全方位送松紧带送带机系列产品/  
侧送型/荧幕操控  
TENSION TYPE COMPUTERIZED METERING DEVICE-SIDE  
FEEDING-MONITOR OPERATION



**JZ-HCT-E9B-M**

微电脑全方位送松紧带送带机系列产品/  
下送型/荧幕操控  
TENSION TYPE COMPUTERIZED METERING DEVICE  
-BOTTOM FEEDING-MONITOR OPERATION



**JZ-HCT-E9U-C**

微电脑全方位送松紧带送带机系列产品  
TENSION TYPE COMPUTERIZED METERING DEVICE



**JZ-HMCA-18K-38/TR**

拷克车用, 附自动切带及送带装置  
FOR OVERLOCK WITH AUTO CUTTING AND  
RE-INSERT



**JZ-HCT-S6C**

饰缝车用  
FOR COVERSTITCH



**JZ-HCT-S6B**

饰缝车用-下送  
FOR COVERSTITCH-FROM  
BOTTOM FEEDING



**JZ-HCT-S6S**

饰缝车用-侧送  
FOR COVERSTITCH-FROM  
SIDE FEEDING



**JZ-HCT-S6Z-B**

人字车-下送  
FOR ZIGZAG-FROM BOTTOM  
FEEDING



**JZ-HCP-3815** 单、双针车用  
FOR SINGLE OR TWIN NEEDLE



**JZ-HCP-3815-C** 饰缝车用  
FOR COVERSTITCH



**JZ-HCP-E** 四针六线用  
FOR 4-NEEDLE 6-THREAD FEED-OFF-THE  
-ARM INTERLOCK FLATSEAMING MACHINE



**JZ-HCB** 适合自动缝制, 前送后拉  
SUITABLE FOR AUTOMATIC SEWING  
FRONT FEEDING AND BACK PULLING



- 可与针车同步, 缝针不易断裂, 可调针目大小  
Simultaneous speed, the needle is unbreakable, pitch is adjustable.
- 倒针时, 拖轮可同时反向转动, 免提起拖轮  
When reverse sewing, puller can pull back at the same time, it doesn't need to lift puller.
- 体积小, 方便安装, 直驱式平车皆可安装  
Compact size, easy to install, for lockstitch with direct-driving motor.

**JZ-HCP-H** 适合全方位电子平车拖轮  
FOR VERSATILE PULLER WITH DIRECT-DRIVING



- 活动式支架, 可直接移动拖轮  
Movable Stand, it can move the puller directly.
- 皮带宽度:  
Belt Width  
17MM
- 液晶显示盒, 可调整针距最大到12MM  
LCD: Adjustable  
Pitch, Maximum  
:12MM



## 闸刀式可自动/半自动前后切刀装置 PNEUMATIC GUILLOTINE AUTO/MANUAL CUTTER

**JZ-HTA-F** 埋夹车/曲手车用  
FOR FEED-OFF-THE-ARM

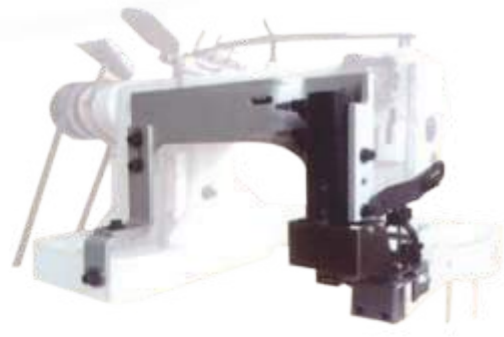

**JZ-HTA-E** 四针六线用  
FOR 4-NEEDLE 6-THREAD FEED-OFF-THE-ARM INTERLOCK FLATSEAMING MACHINE

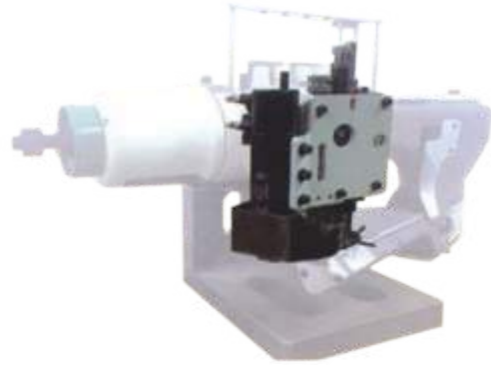

**JZ-HTA-C** 多针车用  
FOR MULTI-NEEDLE SEWING MACHINE

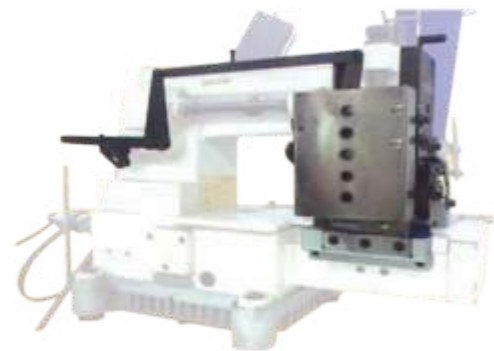

**JZ-HTA-L** 单、双针车用  
FOR SINGLE OR TWIN NEEDLE

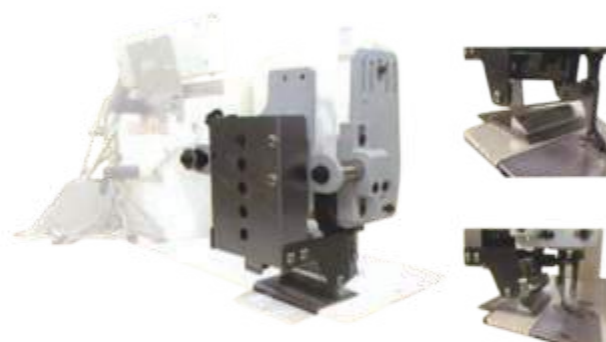

**JZ-HTCM-L50** 触带式切带装置  
MANUAL CUTTING DEVICE

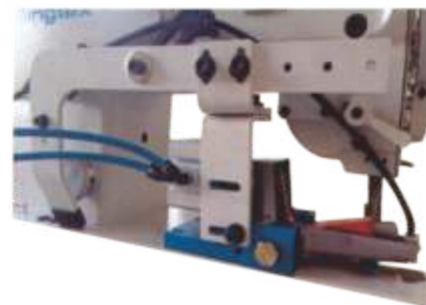

**JZ-HTCA-L50** 光电感应切带装置  
PHOTO-SENSOR CUTTING DEVICE



**闸刀式空间大更方便缝制**  
THE GUILLOTINE-TYPE SPACE IS MORE CONVENIENT TO SEW

## JINZEN®

### JZ-HST-L/HTFU-600/HTA-C

自动收衫机  
-含送料机  
-含闸刀式切刀装置

Automatic Material Receiving Machine  
-with Tape Feeder  
-with Cutter Device

- 用途: 收集西装裤, 衣服...等或压烫裁布  
Application: Stacking for pants, shirts, suit...etc.
- 收集长度: 裁片由20公分~120公分均可  
Stackin Length: Cloth pieces from 20cm to 120cm
- 可计算件数: Quantity can calculate
- 动作示意图Procedures:



### JZ-HST-M/HTFU-600/HTA-C

自动收衫机/送料机/闸刀式切刀装置  
Stacker/Feeder/Cutter



- 控制箱: 设定切带长度及计算件数  
Control Box: TO set length of tape cutting and calculate quantity.



- 附切刀装置  
With cutting assembly



- 裁片尺寸: 10-70公分  
Stacker Length: from 10cm to 70cm



**JZ-HCR**

自动输送带  
AUTOMATIC CONVEYOR



标准尺寸standrad size:

尺寸SIZE	L850*W400MM
转速RPM	0~400 RPM



● 编码器，与针车同步车缝  
Synchronizer



● LCD panel-可调整速度跟上针车速度  
Adjustable speed  
● 输送带材质可选择齿面与平面  
Conveyor belt material can  
Select tooth surface and plan

- 安装于车板上，安装简易，适合大件布料，例如窗帘、床罩、凉被、蚊帐...可配合针车速度同步车缝，令车缝人员轻松缝制而增加效率，提升产能。  
Installed on the table,easy to install suitable for large fabrics,such as:  
Curtains, bedspreads,mosqutio nets....  
Synchronized with the speed of sewing machine.  
Increase efficiency,improve production capacity.
- 特殊规格接受订货生产  
Special specification availabel for sustiom-made



**JZ-FSP-9800**

全自动服装包装机  
AUTOMATIC PACKAGE  
MACHINE FOR GARMENT

- 全自动服装包装机，高速完成折叠，入袋，封装，堆叠动作  
Automatic garment packaging machine,folding at high  
Speed,bagging,sealing,stacking action.
- 适用衣物：T-shirt,POLO衫，夹克，裤子...  
Applicable clothing: t-shirt,polo shirt ,jacket,pants...
- 一人一机，减少人力成本  
1 person,one machine,reducing labor costs



**JZ-SC-7**

全自动包装机  
AUTOMATIC BAGGING AND SEALING MACHINE

- 封装方式:热熔或贴胶纸  
Packing method:hot melt or adhesive tape



**JZ-FD-980**

全自动折衣机  
AUTOMATIC FOLDING MACHINE



# JINZEN® Puller Attachment 拖轮系列产品

## JZ-T-1 间歇性变速器 Intermittent Transmissin

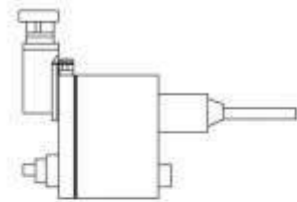

標準品 單位: mm  
Standard Type Unit: mm

機型 Type	a	b	C
S-1	9	65	24
	9	82	38
T-1	9	68	24
	30	98	24
T-2	115	165	24



機型 Model	S-1	T-1	T-2
入力軸轉數(最高) Input Shaft RPM(MAX. SPEED)	2000	3000	3000
出力軸轉數(最高) Output Shaft (MAX. SPEED)	430	225	450
扭力 (Kg/cm) Torque (kg/cm)	12	15	15
重量 (kgs) Weight	2	2	2

## 滾轮规格表 Specification list

### 輪子尺寸 Roller Sizes

D 直徑 Diameter	W 寬度 Width
上輪 Upper Roller	25 10
	27 13
	38 15
	55 15,35,50
下輪 Lower roller	25 60
	27 60

材質 Material			
S 鐵齒面 Steel Teeth		T 塑膠齒面 Plastic Teeth	
D	W	D	W
55	15	27	60
55	50	55	50

### 輪子 Roller



### 輪子材質與外型 Roller material and figures

代號 Code	P	S	T
材質 Material	Pu平面 Polyurethane Plain	鐵齒面 Steel Teeth	塑膠齒面 Plastic Teeth
外型 Figure			

## 电脑平缝机防鸟巢装置

## ANTI BIRD NEST DEVICE FOR COMPUTERIZED LOCKSTITCH SEWING MACHINE



### JZ-HCT-E9B-M

ELECTRONIC-CONTROL  
DUST COLLECTING  
电控集尘组件



使用防鸟巢装置前  
before using anti bird nest device



使用防鸟巢装置后  
after using anti bird nest device



### JZ-HCT-E9B-M

ANTI BIRD NEST DEVICE FOR  
COMPUTERIZED LOCKSTITCH  
SEWING MACHINE  
电脑平缝机防鸟巢装置





## 企业核心价值观

正能量  
凝聚力  
战斗力  
敢创新  
懂感恩

## 品牌核心价值观

专业，丰富，高效

## Enterprise core values

positive energy  
cohesion  
combat effectiveness  
dare to innovate  
full of gratitude

## brand core values

professional, abundant, efficient

### 成长理念

积极成长，成就美好未来  
消极学习，自弃锦绣前程

### 工作理念

认真专注中缔造完美细节  
激情投入间尽显生命尊严

### 营销理念

以解决客户问题为第一原则  
以实现双方共赢为核心思想

### 服务理念

兑现客户意料之中的每个承诺  
实现客户意料之外的更多需求

### 品质理念

在精挑细选中永记质量生命  
在环环把控中铸就非凡品质

### 用人理念

勤奋踏实者赋予更多机会  
勇于担当者委以更多重任

### 执行理念

不偏差，不拖延，不放弃

### GROWING PHILOSOPHY

Aggressively growth achieves your bright future  
Lazy learning ruins your bright future

### WORK PHILOSOPHY

Perfect details root from earnest and concentration  
The dignity of life was reflected in hard work

### MARKETING PHILOSOPHY

Regard solving customers' problems as the first principle  
Consider win win situation as the core idea

### SERVICE PHILOSOPHY

Keep every promise we made to customers  
Bring in more surprises to customers

### QUALITY PHILOSOPHY

Focus on quality when sifting products  
Make top-quality products for focusing on each process

### STAFFING PHILOSOPHY

Provide more chances for diligent and surefooted people  
Give more important tasks to the people with responsibilities

### IMPLEMENT PHILOSOPHY

No deviation, no delay, never give up









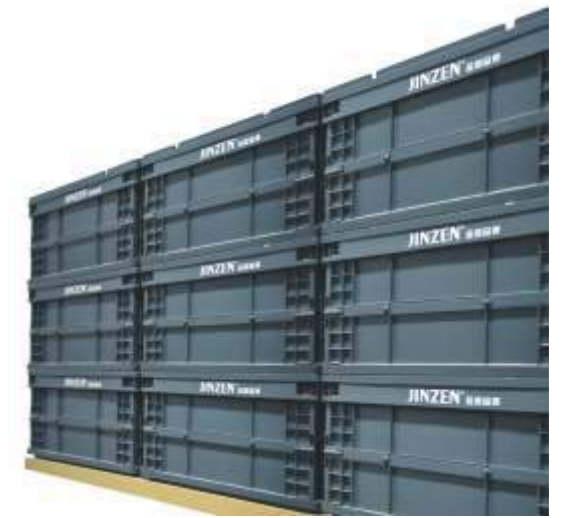

智能仓储 Intelligent storage



# JINZEN®

Stand the test of good quality  
好品质经得起考验

金振企业历经缝配行业20年的专注与投入；  
Sewing field, 20 years' concentration and commitment,

金振品牌12年的铸造与辉煌；  
JINZEN brand, 12 years' casting and resplendence,

产品几百种到50000余种的跨越；  
Products' extending from hundreds to 50000

全球累计3000余家的客户见证；  
More than 3000 customers' witness and ratification ,

产品服务已远销50多个国家和地区；  
Products and services covered 50 countries and regions,

百名以上专业精英团队用心服务；  
Hundreds' elite group serves diligently,

500家高端合作伙伴的联手打造；  
Sincere cooperation with 500 excellent partners,

10多个附加流程的品质绝对保障；  
10 more additional processes to gauntree the quality.







## SINCERE DESIRE

道正信诚是金振人的立业之本；  
明德修身是金振人的必具素养！

CEO:

胡小青  
Erica



微信公众号: JINZENCHINA





# JINZEN®

JINZEN brand include 8 series products, especially in JINZEN hook, bobbin, bobbin case; JINZEN knife; JINZEN needle plate, foot dog; JINZEN looper; JINZEN folder; JINZEN tools; which supported by powerful factories and advanced technology, strict inspection processes, and have won high praise from customers for rich products, Excellent quality and reasonable price. JINZEN people regard "positive energy; cohesion; combat effectiveness; dare to innovate; full of gratitude" as the core values of team, with "To be the benchmark enterprise in the global sewing machine parts field" as the corporate vision, go to meet new and continuous challenges with "try all our best for making JINZEN BRAND to be the synonym of quality in the international stage" as the great mission. JINZEN received many honors over the years, based on JINZEN people's diligence and hard work, we are confident about the future, and will march forward bravely; Let's look forward to JINZEN's brilliant tomorrow.

公司以JINZEN为品牌建立了以JINZEN旋梭、梭壳、梭心; JINZEN针板、送布牙、压脚; JINZEN刀具; JINZEN弯针; JINZEN卷边筒; JINZEN剪刀; JINZEN工具; 以及JINZEN内部配件为主导的八大系列产品, 拥有强大的工厂后盾和先进的技术支持, 以及严格的检测管控流程, 以品种齐全, 品质优良, 物超所值深得客户的高度评价。

金振人正以“正能量、凝聚力、战斗力、勇创新、懂感恩”为团队核心价值观; 以“成为全球缝配领域的标杆企业”为愿景; 以“为金振品牌在国际舞台成为品质的代名词而倾尽全力”为伟大使命的追求下不断挑战。

多年来金振企业获得的一切荣誉无不体现了金振人的勤奋与努力, 面对未来, 我们将更加的信心满满, 勇往直前; 让我们共同期待金振企业的美好明天!





San Gu



message  
from the chairman

## 总裁寄语

金振人以严谨、高效、  
负责任的企业精神，  
站在客户的立场上，  
追求着产品的创新，  
不断拼搏，  
创造无限可能……

掌舵人：

蔡飞扬



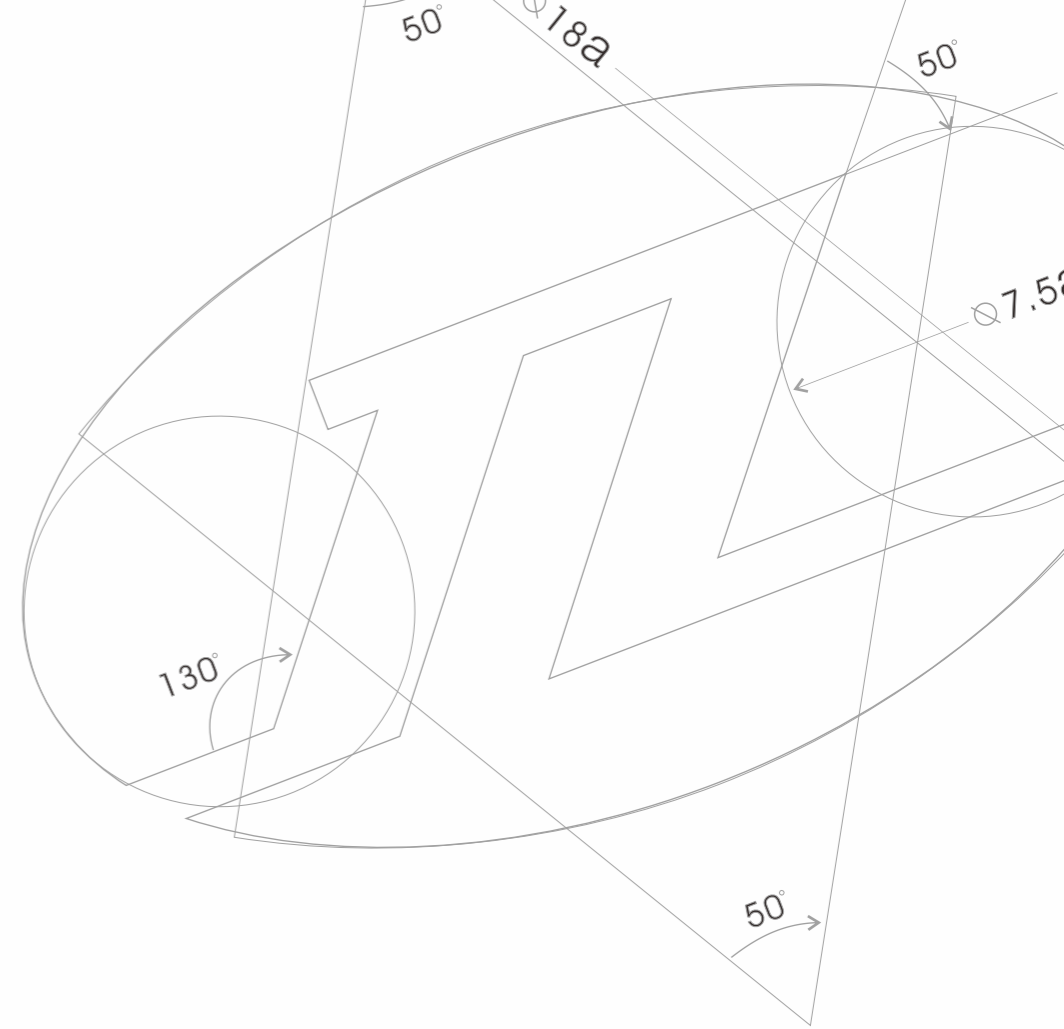

**JINZEN<sup>®</sup>**

The logos of JinZen combine with the first-writing alphabet letters "J", "Z". The outside shape depicts the outline of the earth, it contains all peoples on five continents live together in harmony; with the green background, means "environmental protection, vitality and harmony". Generally speaking JinZen set up a bridge towards to the world then make a communication, cooperation and trade for each other .but also contains JinZen linked the friends together tightly! 金振品牌LOGO是由金振拼音首个大写字母J、Z组合而成，椭圆形的外观抽象为地球，以绿色为主导，寓意着环保、生机、和谐。JZ像似金振人架起的一座沟通世界，走向世界，与其交流、合作、贸易的桥梁，同时象征着将世界各国人民紧紧的系在了一起！

JinZen concept: work hard for make consummate machine, make effectiveness to creating beauty!

为缝纫全人类之衣经纪，为创造可天下之美效力！



## 使命 / Mission:

为金振品牌在国际舞台成为品质的代名词而倾尽全力  
try all our best for making JINZEN BRAND to be the synonym  
of quality in the international stage.

## 使命宣言 / Mission statement:

为同仁创造快乐的氛围与广阔的事业平台  
Create a fun environment and extensive career platform for colleagues

为客户提供系统的服务与绝对的品质保障  
Provide the systematic service and unconditional quality assurance for customers

为社会打造积极的环境与优质的品牌形象  
Create a positive environment and superior brand image for society

为股东带来持续的收益与无限的精神追求  
To bring in revenues for shareholders, also infinitely spiritual pursuit



2005

第一本穿线胶装的  
70p彩色印刷画册，  
于上海光大展览会发布。



2006

第二本穿线胶装的  
130p彩色印刷画册，  
于上海新国际博览中心发布。



2007

成立金振进出口有限公司，  
拥有自营进出口权，  
导入VI视觉识别系统，  
以全新的184P画册版面设计  
向国家版权局递交申请保护，  
发布上海新国际博览中心。  
版权号:2009-L-00021791



2009

向金振VIP客户赠送采用  
精装成册的新版284P画册，  
发布上海新国际博览中心。  
版权号:2009-L-00021792



2011

全新升级后的372p新版画册，  
发布上海新国际博览中心。  
版权号:2013-L-00094541



2013

提升视觉形象设计，  
以全球服务商定位为基准，  
画册408p，  
发布上海新国际博览中心。  
版权号:2015-L-00236843

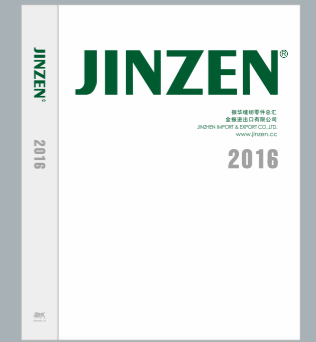

2015

汇总升级后的新版画册，  
436p，更加全面和快捷  
发布上海新国际博览中心。  
版权号:2015-L-00236844



2017

企业30+周年刊  
回顾金振品牌历史  
诠释产品完美品质，  
画册84p，  
发布上海新国际博览中心。

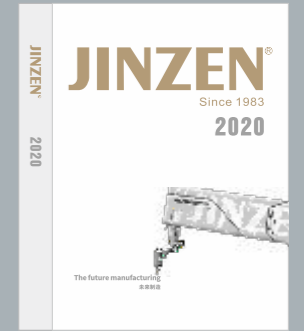

2019

世纪力作，完善产品目录  
提升服务全球代理商  
画册424p，  
发布上海新国际博览中心。  
版权号:已递交国家版权局



1997

第一份黑白胶印印刷折页，  
于上海光大展览会发布。



2000

第一份由人民照相馆摄影拍照，  
印刷彩色印刷折页，  
于上海光大展览会发布。



2003

第一本骑马钉装订成册的  
彩色印刷画册，  
于上海光大展览会发布。

我们的成长史  
Our Growth history





# CISMA 2019

2019中国国际缝制设备展览会  
上海新国际博览中心  
2019年9月25日-28日

## E7馆-M15

WELCOME TO JINZEN



2008版权证书 证书号:00021791



2012版权证书 证书号:00094541



2010版权证书 证书号:00021792



2014版权证书 证书号:00236843



2016版权证书 证书号:0000236844



2020版  
本版本已递交国家版权局申请登记。

## 版权声明：

- 1.本画册中所有设计版面及效果已向国家版权局登记，受法律保护。
- 2.画册中产品包装已申请专利，
- 3.画册中涉及到的金振系列商标，均属于金振公司所有，请勿仿冒！



以上知识产权未经允许，任何单位和个人不得刊登、转载，扫描或以其它方式使用上述作品

# 封三